



## MacBook (13-inch, Early and Mid 2009)

---

MacBook (13-inch, Early 2009), MacBook (13-inch, Mid 2009)

Updated 2010-07-12

---

 Apple Inc.

© 2009 Apple Inc. All rights reserved.

Under the copyright laws, this document may not be copied, in whole or in part, without the written consent of Apple.

Every effort has been made to ensure that the information in this document is accurate. Apple is not responsible for printing or clerical errors.

Apple  
1 Infinite Loop  
Cupertino, CA 95014-2084  
USA  
+ 1 408 996 1010  
[www.apple.com](http://www.apple.com)

Apple, the Apple logo, Mac, and MacBook are trademarks of Apple Inc., registered in the U.S. and other countries.

---

# MacBook (13-inch, Early and Mid 2009)

## Contents

### Take Apart

Manual Updates 8

General Information 9

What's New 9

Product Configurations 10

New NVIDIA GeForce 9400M graphics processor 11

Liquid Submersion Indicator (LSI) Locations 12

Cable Connector Names on Logic Board 13

JST Connectors 13

Foam Sponges on the Logic Board 14

Logic Board Spring 14

Keyboard and Function Keys 15

Keycap Replacement 16

Tools 16

Temperature Concerns 17

Note About Images in This Manual 17

Serial Number Location 17

Transferring the Serial Number 18

Simplified Flowchart for Removing Modules 19

Battery 20

RAM Door (L-Bracket) 23

Memory (DIMMs) 27

Removal Procedure 28

Replacement Procedure 29

Removing a Stuck Memory Card 31

Hard Drive 32

Top Case (with Keyboard) 35

Top Case/Display Bezel Kit 45

New Kit Available in July 2010 45

Before Ordering Parts 45

Note About International Parts 45

---

Trackpad Cable	46
Hard Drive Snubbers, Front and Rear	51
AirPort Extreme Card	54
MagSafe DC-In Board	57
Left Speaker	61
I/O Frame (with upper EMI shield)	64
Battery Connector with Sleep Switch	67
Hard Drive Connector	71
Fan	77
Heatsink	80
Checking the Thermal Grease	84
Bluetooth Holder	87
Optical Drive	91
Handling Slot-Load Optical Drives	98
Removing a Stuck Disc from an Optical Drive	102
Optical Drive Cable	104
Bluetooth Antenna Board and Cable	107
Bluetooth Board	111
Bluetooth-to-Logic-Board Cable	114
Subwoofer with Right Speaker Cable	118
Midframe	124
Logic Board	126
Display Bezel	134
Removal Procedure	135
Replacement Procedure	138
Bezel Mounting Clips	141
Removal Procedure	142
Replacement Procedure	143
Spacers at Bezel Scoops	145

---

Shims at Display Bezel Scoops	147
Clutch Block, Left	150
Clutch Block, Right	154
Clutch Caps	158
(Refer to "Clutch Block, Left" and "Clutch Block, Right")	158
Display Module	159
Bottom Case	165
Clutch Cover	168
Bezel Scoops, Left and Right	174
LCD Panel	177
Antenna Receptors and Cables, Top and Left	182
LCD Panel Assembly	187
Removal Procedure	189
Reinstallation Procedure	193
Spacers at Camera Bracket	201
Camera Assembly	203
LVDS Cable with USB Line	209
Microphone Cable	215
Inverter Board	222
Inverter Cable	225
Display Hinges, Left and Right	228
Bezel Brace, Left	231
Bezel Brace, Right	233
Sleep Magnet	237
Display Magnet Pairs	240
Display Rear Housing	244
<b>Troubleshooting</b>	
General Information	248

- 
- Troubleshooting Aids and Tips 248
  - MacBook Firmware Updates 250
  - Software Troubleshooting Tips and Tools 251

## Troubleshooting Steps 252

## Symptom Charts 255

- How to Use the Symptom Charts 255
- AirPort 255
- Temperature Issue 256
- Memory 257
- Power, Battery, or Startup Issue 258
- Power-On Self Test (POST) Error Codes 265
- Optical Drive 265
- Keyboard and Trackpad 267
- USB / FireWire Ports 267
- Video 268
- Sound Output 270
- Applications 271

## Block Diagram 273

## Views

### External and Internal Views 275

- Front: Keyboard and IR Window 275
- Back: Air Vents and Display Clutch 276
- Left Side: Ports 276
- Right Side: Slot Drive 276
- Battery Bay: Memory Card Levers and Hard Drive Pull Tab 277
- Top Case Removed: Main Modules and Cable Routing 277

### Screw Charts 282

- Top Case Screw Locations 282
- Display Module Screw Locations 283
- Logic Board Screw Locations 284
- LCD Panel Screw Locations 285
- Screw Reference Chart, Part 1 of 3 286
- Screw Reference Chart, Part 2 of 3 287
- Screw Reference Chart, Part 3 of 3 288

### Exploded Views 289

- MacBook (13-inch, Early 2009) and
- MacBook (13-inch, Mid 2009)—Display Exploded View 289
- MacBook (13-inch, Early 2009)—Main Exploded View 290
- MacBook (13-inch, Mid 2009)—Main Exploded View 291



Take Apart  
MacBook (13-inch, Early 2009)



# Manual Updates

## Updated 12 July 2010

### Take Apart:

- Top Case/Display Bezel Kit: Added new topic describing how to order a kit that includes both a top case and a display bezel

### Views:

- Exploded Views: Updated top case and display bezel part numbers

## Updated 14 May 2010

### Take Apart > General Information:

- Added new section “Keycap Replacement.”

### Additional Procedures

- Deleted chapter; replaced by “Keycap Replacement” in Take Apart > General Information.

### Troubleshooting > Symptom Charts > Keyboard and Trackpad

- Changed procedure for “Keycap damaged or sticking” to refer to “Keycap Replacement.”

## Updated 26 May 2009

### Take Apart > Heatsink:

- For MacBook (13-inch, Early 2009): Some units do not have a thermal sensor cable on the heatsink, though replacement heatsinks may have a thermal cable. The heatsink removal and replacement procedure has been updated to reflect this part differentiation.

### MacBook (13-inch, Mid 2009):

- Added content for this new model

## Manual introduced 21 January 2009



# General Information



## What's New

The MacBook (13-inch, Early 2009) and MacBook (13-inch, Mid 2009) portable computers have a 1066 MHz frontside bus, 2 GB of standard memory (expandable to 4 GB), and a 2.0 or 2.4 GB processor, respectively.

The main changes to the MacBook (13-inch, Mid 2009) from the MacBook (13-inch, Early 2009) are the following:

- 800MHz RAM, compared with 667MHz for the (Early 2009)
- New hard drives, from 160 to 500 GBs
- New 2.13 GHz logic board (does not have a thermal sensor cable connector socket)
- New heatsink (does not have a thermal sensor connector cable)

---

The main features and service differences from the previous non-aluminum MacBook models include:

- A new NVIDIA GeForce 9400M graphics chip with 256 MB of VRAM (shared with system RAM)
- Additional Liquid Submersion Indicators:
  - three on the underside of the top case
  - one on the logic board
  - one on the battery cable connector
- A backup battery which is no longer a separate part, but rather a surface mount capacitor built onto the underside of the logic board
- Weight reduced to under 5 pounds

## Product Configurations

The MacBook (13-inch, Early 2009) and MacBook (13-inch, Mid 2009) model configurations at introduction:

Feature	MacBook (13-inch, Early 2009) Specifications	MacBook (13-inch, Mid 2009) Specifications
Intel Core 2 Duo processor	2.0 GHz	2.13 GHz
Memory	667MHz, 2 GB (2 x 1 GB) standard; up to 4 GB (2 x 2 GB) CTO	800MHz, 2 GB (2 x 1 GB) standard; up to 4 GB (2 x 2 GB) CTO
Hard Drive, Serial ATA 5400 rpm	120 GB standard, 160 GB, 250 GB, or 320 GB CTO	160 GB standard, 250 GB, 320 GB, or 500 GB CTO
Optical Drive	Super, 9.5 mm	
Housing	White	
Display	13.3-inch, 1280x800, 114 dpi, Low Reflection Glossy Polarizer (LRGP)	
Battery	55-Whr Lithium Polymer	
Power Adapter	60 W MagSafe MPM	

---

## New NVIDIA GeForce 9400M graphics processor

The new NVIDIA GeForce 9400M graphics processor, with increased 256MB of DDR2 SDRAM (shared with main memory), speeds up graphic performance for movies, games, video, image editing and system graphics like Dashboard and Cover Flow.

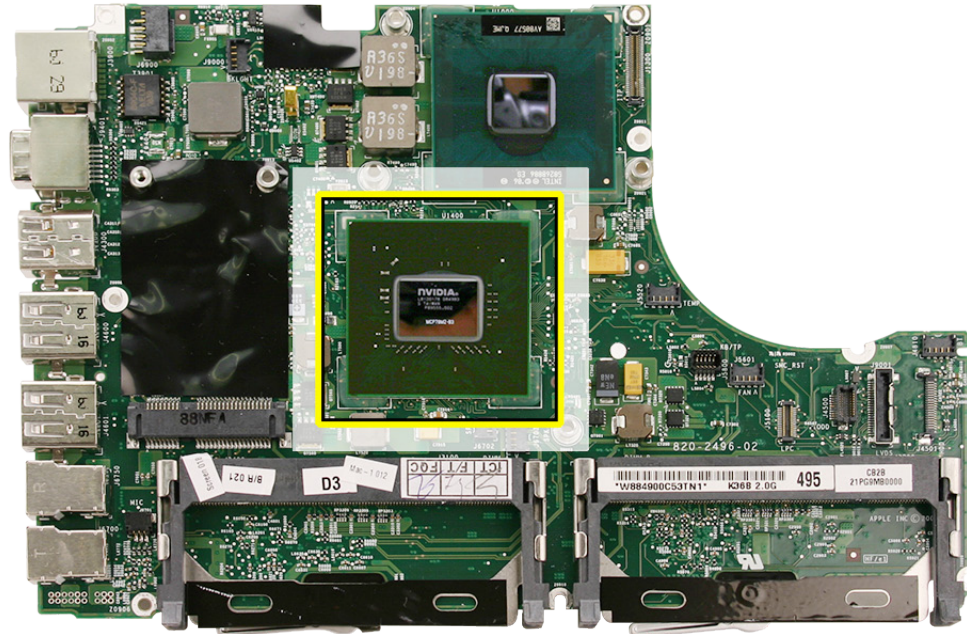

## Liquid Submersion Indicator (LSI) Locations

To help determine accidental damage, the MacBook's top case, logic board and battery cable connector include spill sensors called liquid submersion indicators (LSIs). These small white dots turn red when they come in contact with liquid, such as an accidental spill.

There are three LSIs under the keyboard of the top case. Note that for research and engineering purposes the top case will now be a returnable 661- part instead of a 922- part.

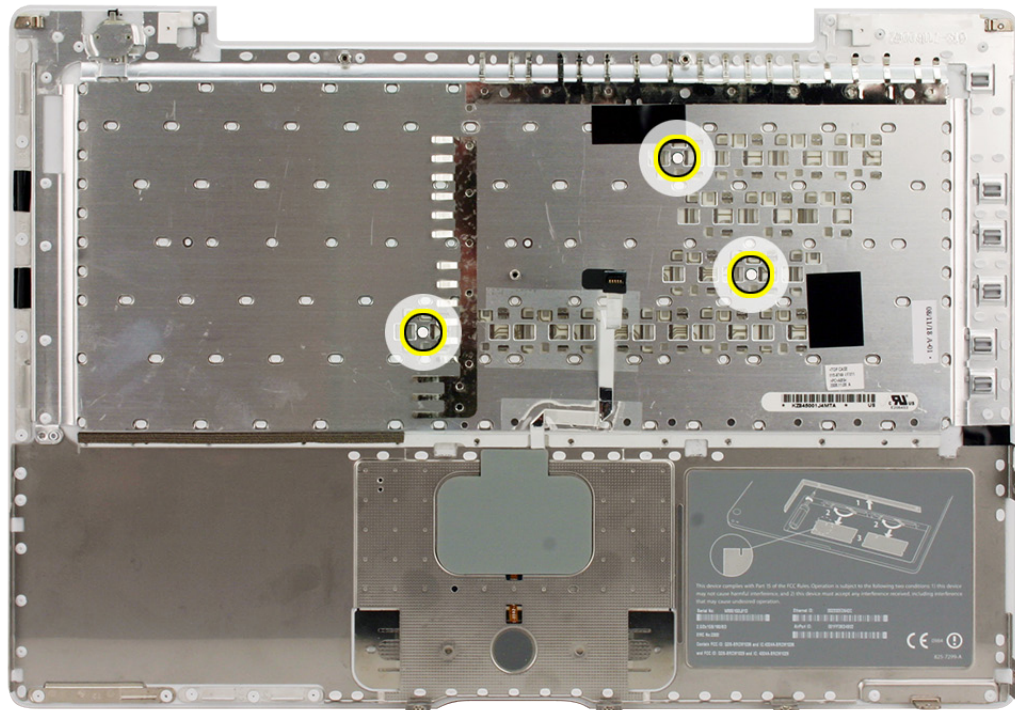

There is one LSI on the battery cable connector, and one on the main logic board.

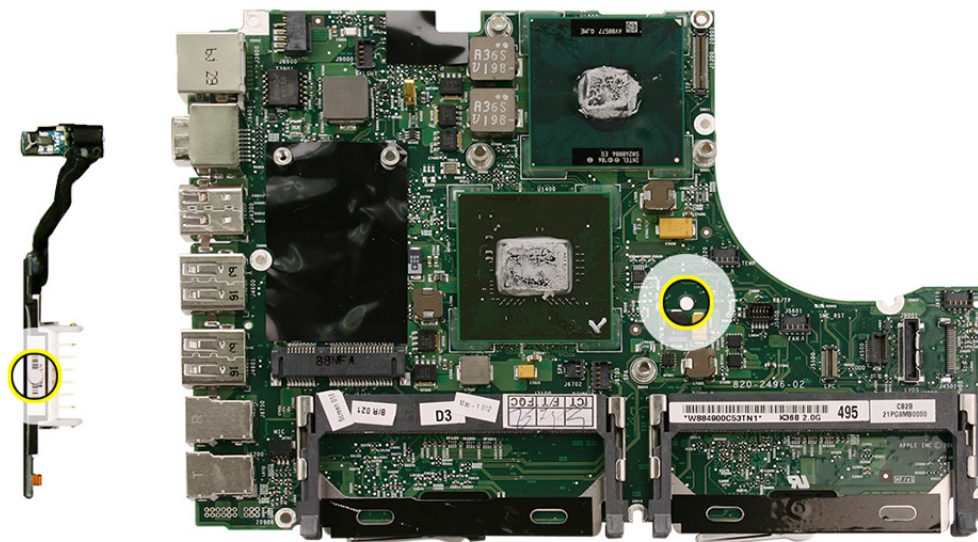

## Cable Connector Names on Logic Board

To aid in servicing the computer, the logic board includes abbreviated names for connectors:

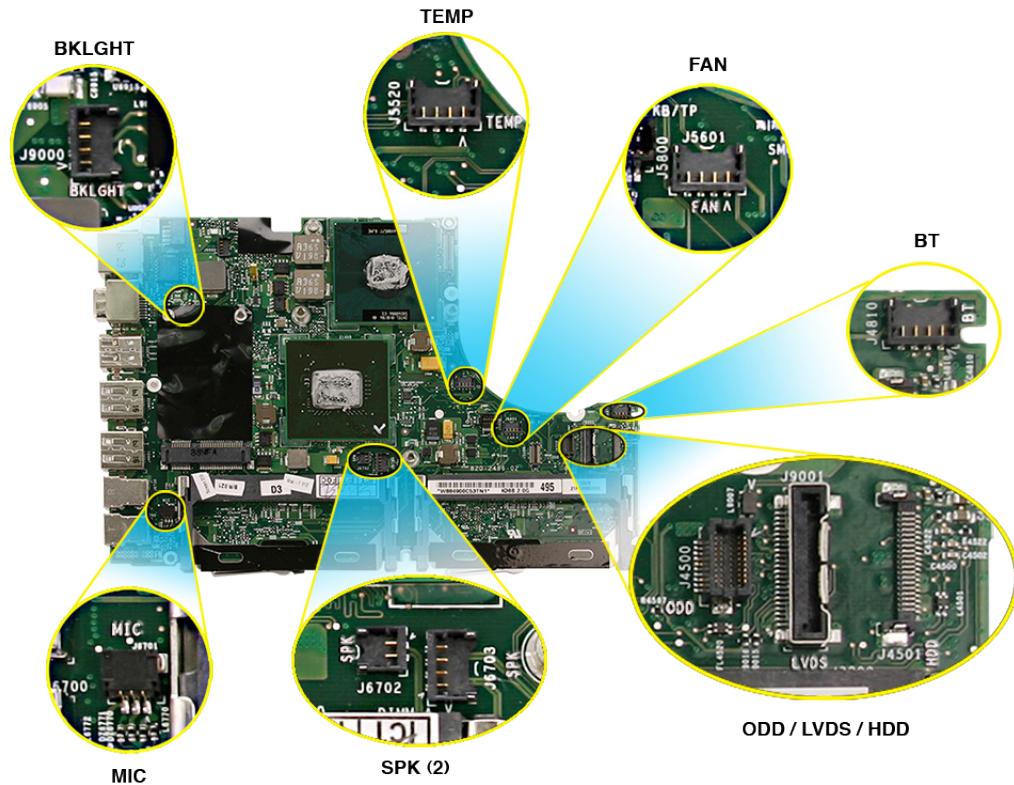

BKLIGHT = Inverter cable for backlight

TEMP = Heatsink thermistor cable

FAN = Fan cable

BT = Bluetooth cable

ODD = Optical drive flex cable

LVDS = LVDS display cable

HDD = Hard drive cable

SPK = Left speaker cable

SPK = Right speaker cable and subwoofer

MIC = Microphone cable

## JST Connectors

Remember to handle JST connectors carefully, using a black stick or finger to support cables when disconnecting and make sure mated parts are aligned and level before reconnecting.

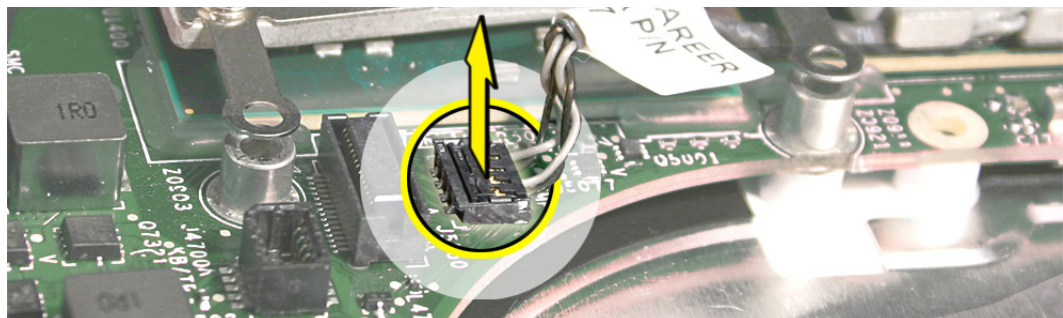

---

## Foam Sponges on the Logic Board

The logic board has two foam sponges: one covering the inverter connector above the AirPort Extreme Card, and one covering the thermistor connector next to the heatsink. The foam sponges have a light adhesive on one side that keep them in place. While they can be removed for service, they must be reinstalled.

**Caution:** When servicing the computer and before replacing the top case, make sure these two foam sponges are undamaged and in place.

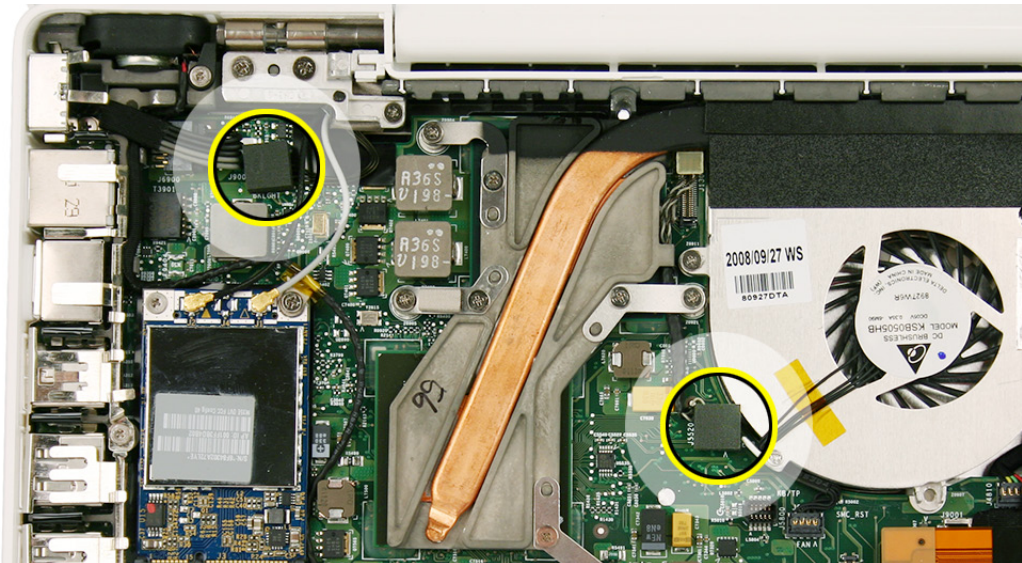

## Logic Board Spring

**Caution:** When servicing the computer, be especially careful when working near the spring on the logic board, located just above the AirPort Extreme Card. Although the spring is flexible, it can be inadvertently torn, bent, or broken if a cable gets caught on it. A logic board might be considered unusable with a damaged spring. Check the structural integrity of the spring before installing the top case and completing a repair.

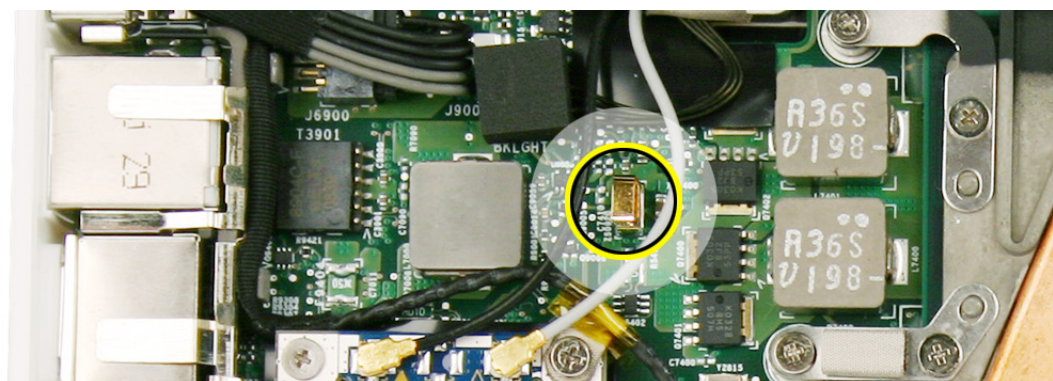

## Keyboard and Function Keys

Images on the function keys include Exposé and Dashboard. Refer to the following table for function key explanations:



Function Key	Feature
F1, F2	Decrease or increase the display brightness
F3	Exposé allows quick access to all open windows
F4	Dashboard allows access to widgets
F5, F6	Programmable keys
F7–F9	Media controls for rewind, play, or fast forward
F10	Mute the sound coming from the speakers or headphone port
F11, F12	Decrease or increase volume from speakers or headphone port

---

## Keycap Replacement

Service packages of 78 replacement keycaps are now available in the U.S. and Canada (U.S. version keyboard only) for designated MacBook and MacBook Pro computers. The packages allow you to replace individual keycaps rather than the entire top case.

There are four different keycap packages, based on the color of the key and the type of keyboard (version D and S).

Part number	Key color	Keyboard
922-9277	Black	Version D
922-9279	Black	Version S
922-9278	White	Version D
922-9280	White	Version S

For step-by-step instructions, refer to the relevant support article: [“MacBook/MacBook Pro: Black Keycap Replacement” \(HT4002\)](#) or [“MacBook: White Keycap Replacement” \(HT4003\)](#).

For an overview of the differences among keycap procedures, refer to [“MacBook/MacBook Pro: Keycap Replacement Matrix” \(HT4001\)](#).

## Tools

**Caution:** To prevent scratches or other cosmetic damage to the computer housing, use a soft cloth as a protective layer when removing and installing the external screws.

The tools required to service this computer include:

- Clean, soft, lint-free cloth
- Coin
- ESD wrist strap and mat
- Magnetic Phillips #0 screwdriver
- Magnetic Phillips #00 screwdriver (preferably with a long handle)
- Black stick (Apple part number 922-5065) or other nonconductive nylon or plastic flatblade tool
- Access card (Apple part number 922-7172) to open the top case
- Jeweler’s flatblade screwdriver
- Needlenose pliers
- Stack of books, weighted boxes, or other means of support for display while removing screws from hinge
- Thermal grease (Apple part number 922-7144)
- Alcohol wipes
- Permanent marking, felt-tip pen
- Standard size CD or DVD disc
- Flashlight or bright lamp

## Temperature Concerns

The normal operating temperature of this computer is well within national and international safety standards. Nevertheless, customers may be concerned about the generated heat. To prevent an unneeded repair, you can compare a customer's computer to a running model, if available, at your repair site. For more information on temperature concerns and customer perception, refer to Knowledge Base article 30612 "Apple Portables: Operating Temperature."

<http://docs.info.apple.com/article.html?artnum=30612>

## Note About Images in This Manual

Because a pre-production model was used for most of the images shown in this manual, you may notice small differences in appearance between the image pictured and the computer you are servicing. However, although the appearance may differ, the steps and sequence are the same unless noted.

## Serial Number Location

The computer serial number is located in the battery bay, as shown below. You can also find the serial number by opening the Applications folder and selecting Utilities/System Profiler/Hardware. Or from the Apple menu, select About This Mac, and click the version number below the words "Mac OS X" to cycle among the version number, build number, and serial number.

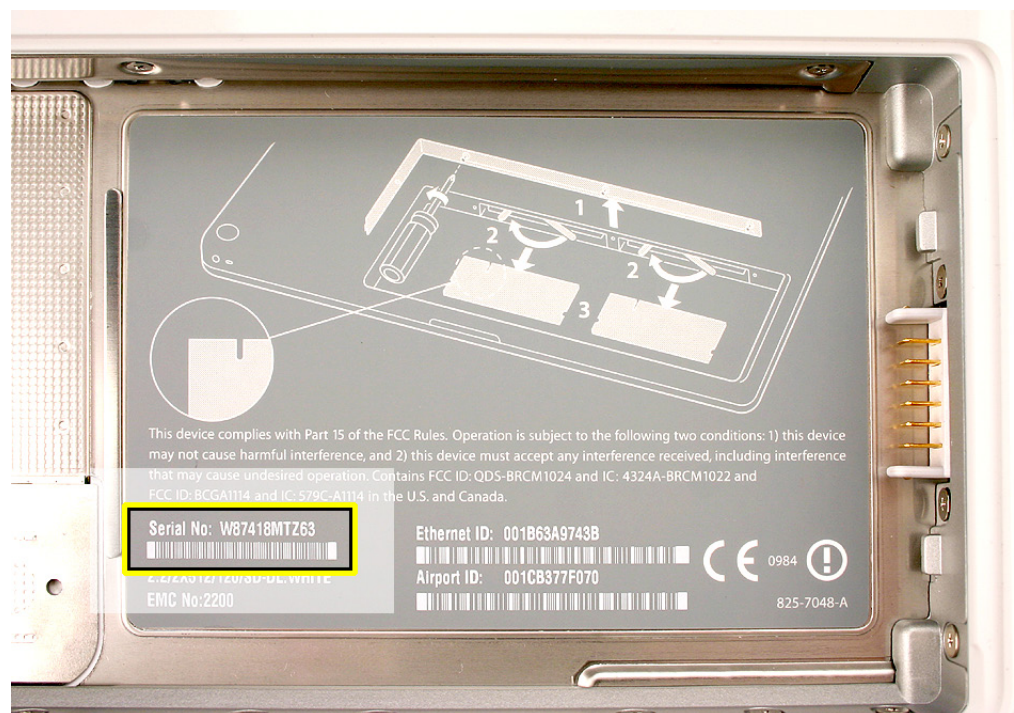

---

## Transferring the Serial Number

When replacing a top case, retain the customer's top case until the repair is complete. Before installing the replacement top case, transfer the serial number from the original top case to the replacement.

**Caution:** It is imperative that you copy the correct alphanumeric characters. Keep in mind that Apple serial numbers use the numbers 1 and 0 instead of the Roman letters "l" and "O."

1. Locate the blank space for the serial number on the battery-bay area of the replacement top case.
2. On the *inside* surface of the replacement top case, use a fine-tip permanent marker to write the original serial number clearly and legibly in uppercase box letters.

## Simplified Flowchart for Removing Modules

Although this flowchart does not include every serviceable part, you can use it as a reference after becoming familiar with the detailed removal procedures.

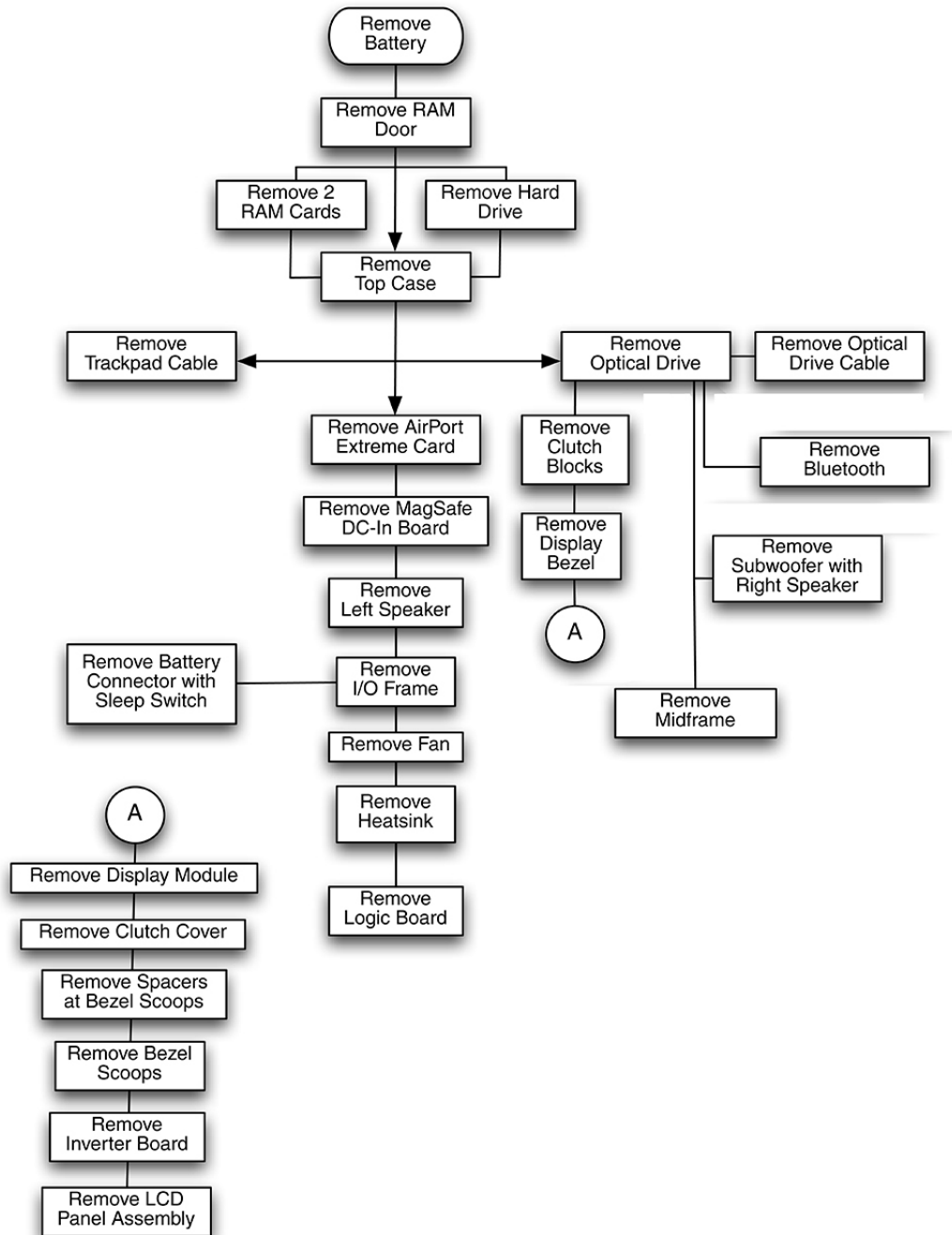



# Battery

## Tools

- Clean, soft, lint-free cloth
- Coin

## Part Location



## Preliminary Steps

**Warning:** Always shut down the computer before opening it to avoid damaging the internal components or causing injury. After you shut down the computer, the internal components can be very hot. Let the computer cool down for 30 minutes before continuing.

---

## Procedure

1. Shut down the computer.
2. Wait 30 minutes to allow the computer's internal components to cool.
3. Unplug all external cables from the computer except the power cord.
4. Unplug the power cord.
5. Put on an ESD wrist strap.
6. Turn over the computer and place it on a soft cloth.

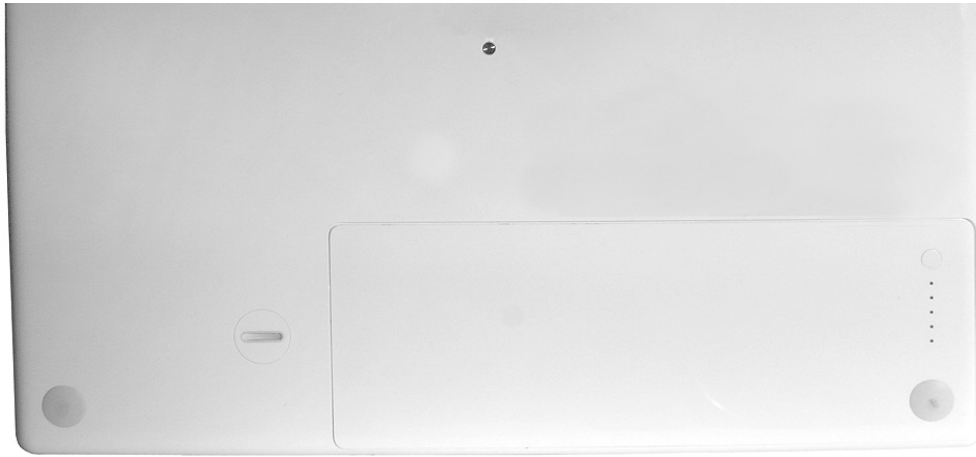

7. Use a coin to release the battery latch. Turn the coin a quarter turn clockwise to unlock the battery.  
**Caution:** To prevent scratches or other cosmetic damage to the bottom case, use only a coin to unlock and lock the battery.
8. Lift out the battery from the battery bay.



- 
9. To install the replacement battery, tilt the foot end of the battery into the battery bay first. Then press and hold down the other end of the battery as you turn the coin to lock it into place.



10. Reassemble and test the computer.



## RAM Door (L-Bracket)

### Tools

- Soft cloth
- ESD wrist strap and mat
- Magnetic Phillips #0 screwdriver
- Black stick (Apple part no. 922-5065) or other nonconductive nylon or plastic flatblade tool

### Preliminary Steps

Before you begin, remove the [battery](#).

### Part Location

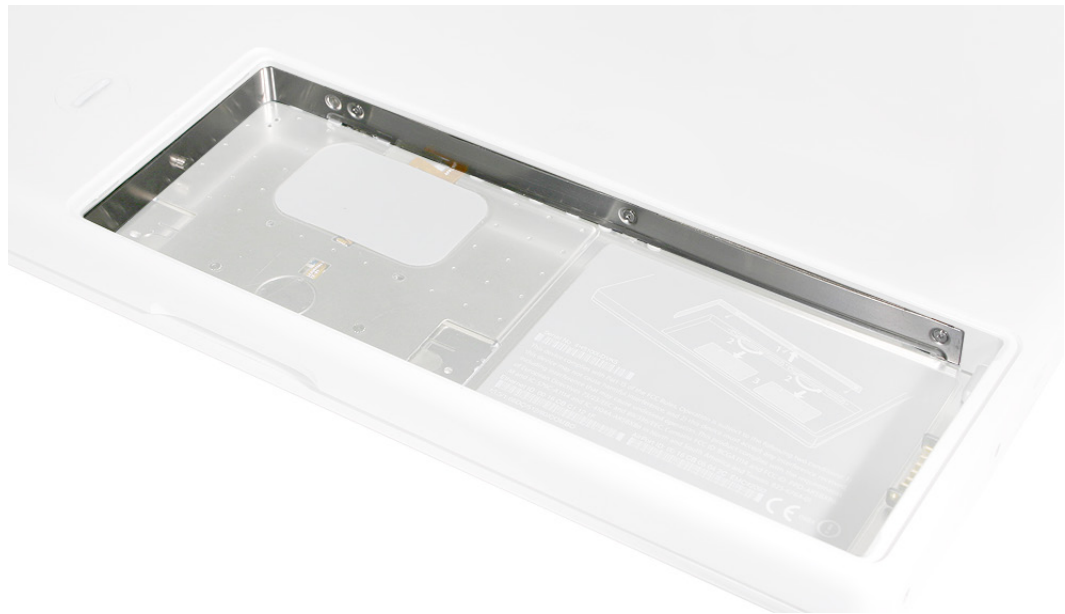

## Procedure

1. With the computer closed and upside down on a soft cloth, touch a metal surface inside the battery bay to discharge any static electricity.



2. Loosen—but do not try to remove—the three captive screws along the RAM door.

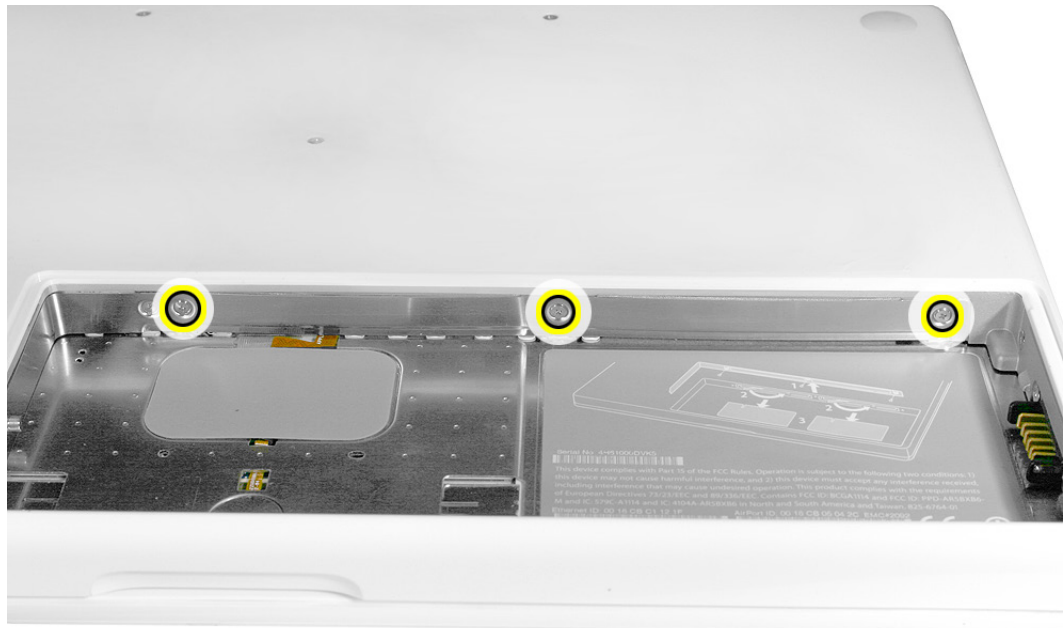

- 
3. Holding the long end of the L-shaped RAM door, pivot it out from the battery bay. (If necessary, use a black stick to tilt it up and out of the battery bay.) Be careful not to bend it.



**Replacement Note:** Before replacing the RAM door, make sure that

- Hard drive pull tab is not exposed
- Cards are fully inserted
- Memory card levers are fully down before replacing the RAM door

**Replacement Note:** Check that the replacement RAM door has a rubber cushion to protect the hard drive opening and two EMI gaskets to protect the memory card openings.

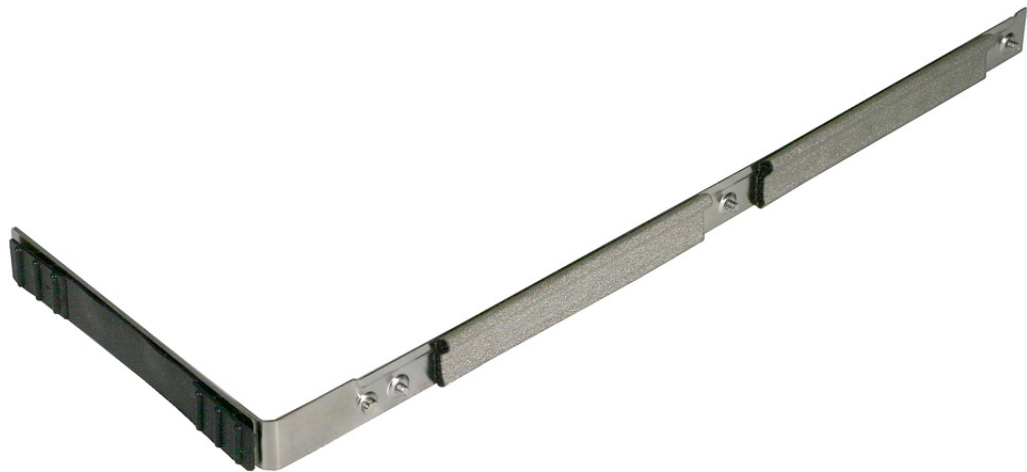

- 
4. **Replacement Note:** Install the replacement RAM door by first aligning the short end at the notch near the hard drive opening.

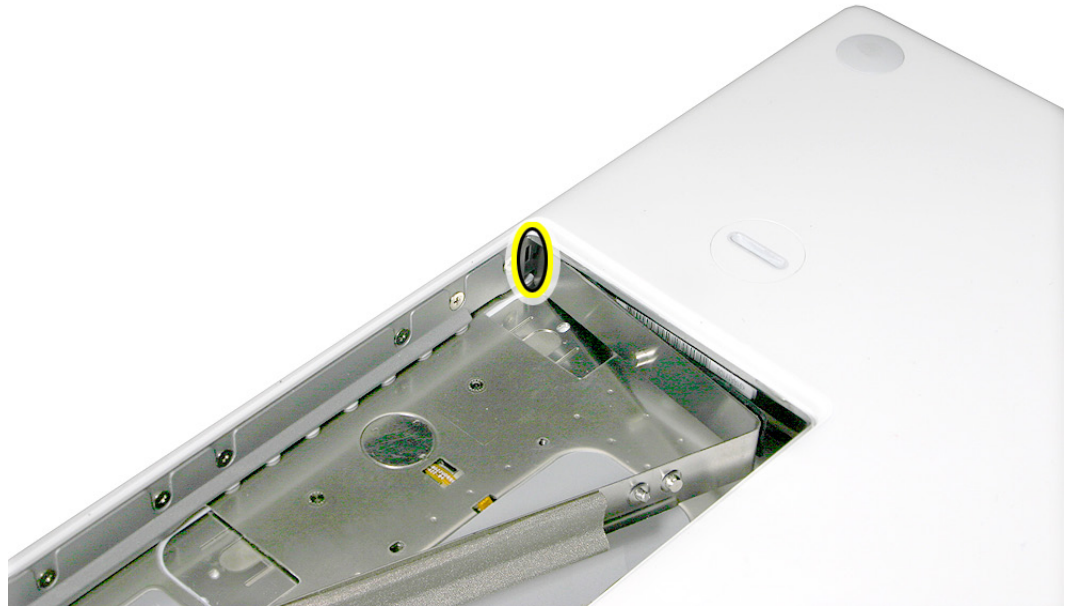

**Replacement Note:** Use a black stick, if necessary, to tuck in the EMI gaskets so they do not protrude from the edge of the battery bay. Make sure the three screws align with the holes in the bottom case before tightening them.

5. Reassemble and test the computer.





## Memory (DIMMs)

This computer comes with a minimum of 2 GB of 667 MHz Double Data Rate 2 (DDR2) Synchronous Dynamic Random-Access Memory (SDRAM) installed. It has two slots that can accept SDRAM Small Outline Dual Inline Memory Modules (SO-DIMMs). The slots are side-by-side on the logic board behind the RAM door. For best performance, memory should be installed as pairs with an equal memory card in each slot. The maximum amount of memory for this computer is 4 GB, with 2 GB DIMM installed in each slot.

Memory cards must meet these requirements:

- 1.25 inch or smaller
- 1 GB, or 2 GB
- 200-pin
- PC-5300 DDR2 667 MHz Type RAM

### Tools

- ESD wrist strap and mat

### Preliminary Steps

Before you begin, remove

- [Battery](#)
- [RAM door](#)

### Part Location

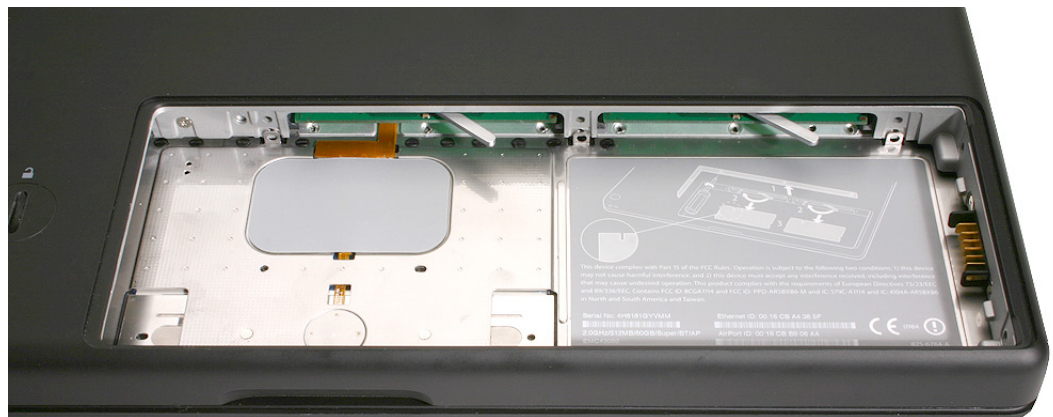

---

## Removal Procedure

1. Touch a metal surface inside the battery bay to discharge any static electricity.
2. Put on an ESD wrist strap.
3. In one swift motion, use one finger to move the lever to the left and release it. This swift motion ejects the memory card.

**Caution:** The memory card eject levers are on a spring hinge that operates on a side-to-side horizontal plane. The mechanism can be damaged if the lever is forced outside of that horizontal movement. To prevent damage to a lever, move it swiftly—in one sideways direction only.

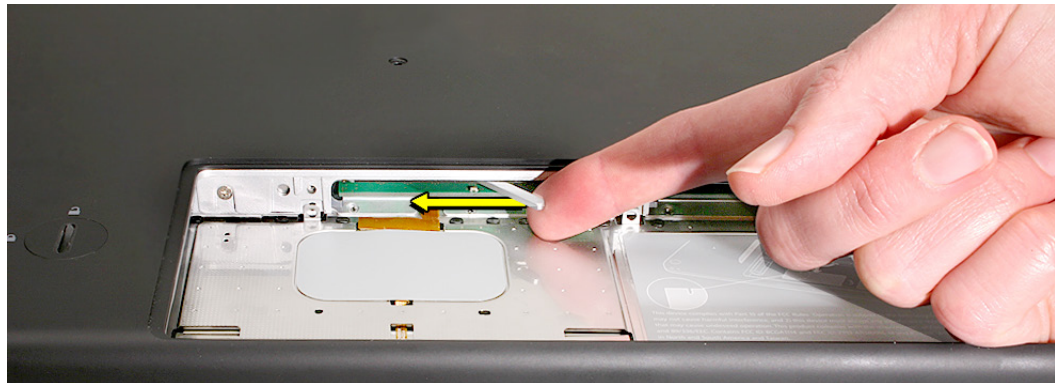

**Note:** Unlike previous MacBook models that allowed you to replace damaged or malfunctioning DIMM levers with a part kit, you may need to replace the logic board.

If the lever is stuck in a completely closed position (recessed underneath the bottom case), use a wooden pencil or black stick to gently pry it out, as shown below.



4. Holding the memory cards by the corners, slide them out from the battery bay.

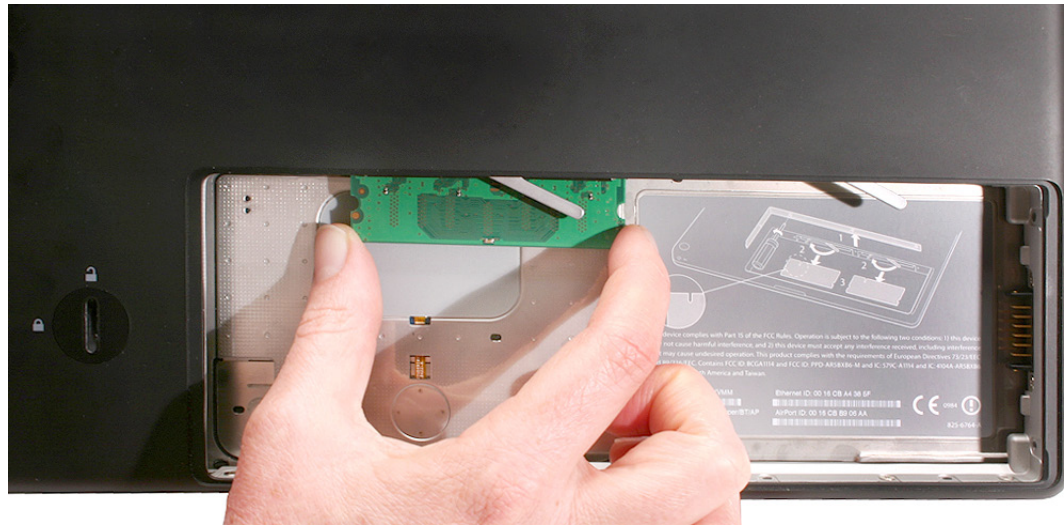

**Important:** Do not touch the gold connectors. Handle the card only by its edges.

**Note:** A memory card might show a white residue when you remove it. This harmless substance acts as a lubricant when installing the memory card at the factory, but it is not required when reinstalling a memory card.

## Replacement Procedure

1. Align the memory card so that the gold connectors face the slot and the notch is on the left. (The chip side of the board faces down.)

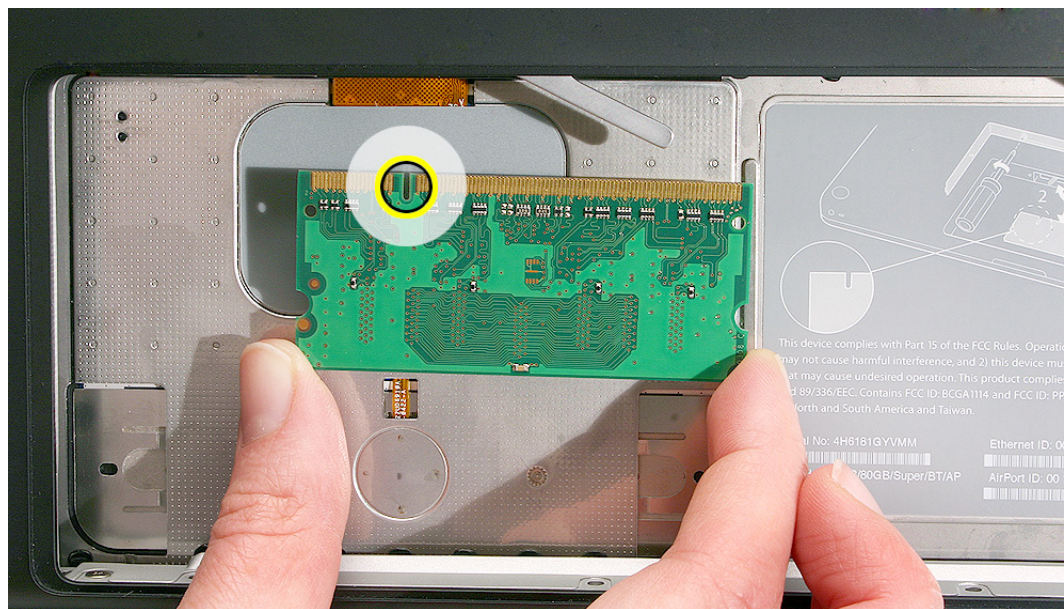

2. Use two fingers to push firmly on the edge of the memory cards. If there is a tight fit, installing the cards may take some force to ensure that they are fully inserted.



**Important:** When the cards are fully inserted, the edges of the cards are nearly hidden, as shown by the recessed card on the right in the image below.



3. If the levers do not return to the closed position, move them to close them.
4. Reassemble and test the computer.
5. Make sure the computer recognizes the new memory by opening System Profiler, clicking More Info, and clicking Memory.

---

## Removing a Stuck Memory Card

If a lever becomes inoperable and does not eject a memory card, you must remove the top case to access the stuck memory card. Follow this procedure only if the memory card is stuck and cannot be ejected by using the lever.

1. Follow the “Top Case” procedure in this chapter to remove the top case.
2. Notice the eject bars on each side of the memory card carrier. Use a black stick to push and slide the eject bar down the side of the carrier.

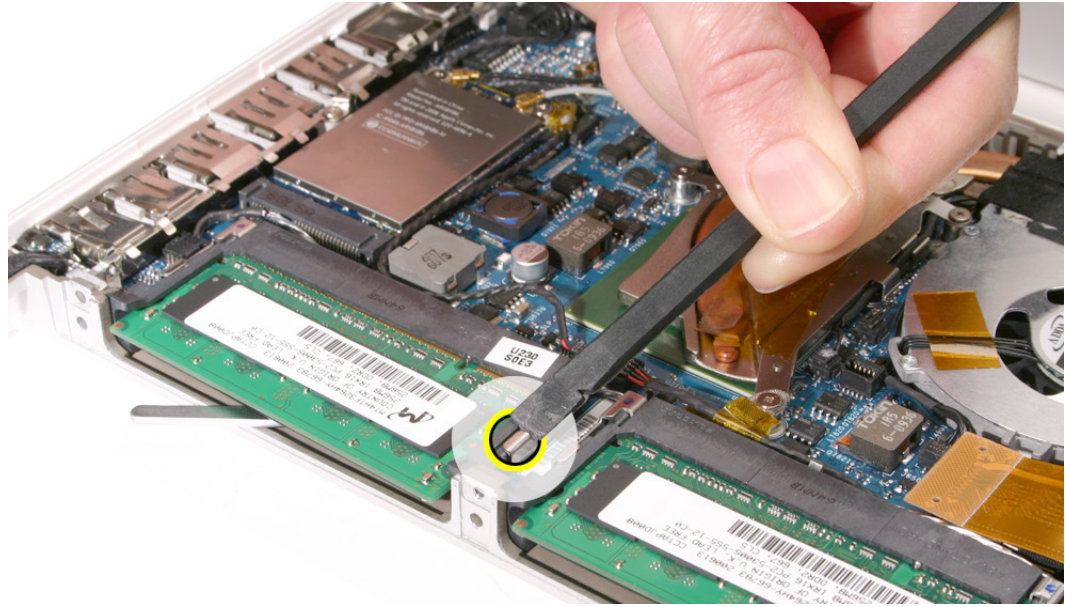

3. Repeat step 2 on the other side of the memory card carrier until the memory card pops out.

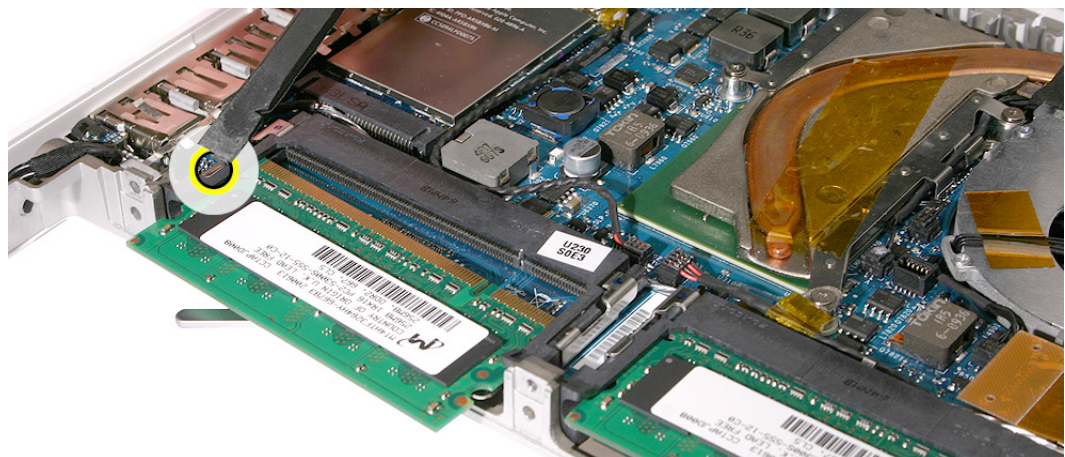



# Hard Drive

## Tools

- ESD wrist strap and mat
- Black stick (Apple part no. 922-5065) or other nonconductive nylon or plastic flatblade tool

## Preliminary Steps

Before you begin, remove

- [Battery](#)
- [RAM door](#)

## Part Location



---

## Procedure

1. If the hard drive pull-tab is tucked in, use a black stick to unroll it.

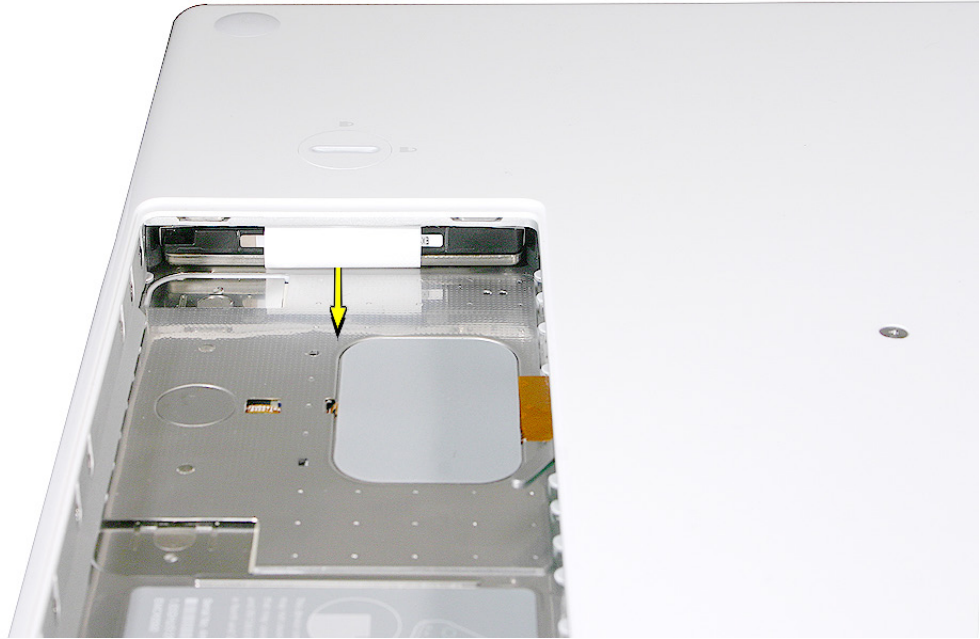

2. Pull the tab straight out to slide the drive out from the rubber rails in the battery bay.

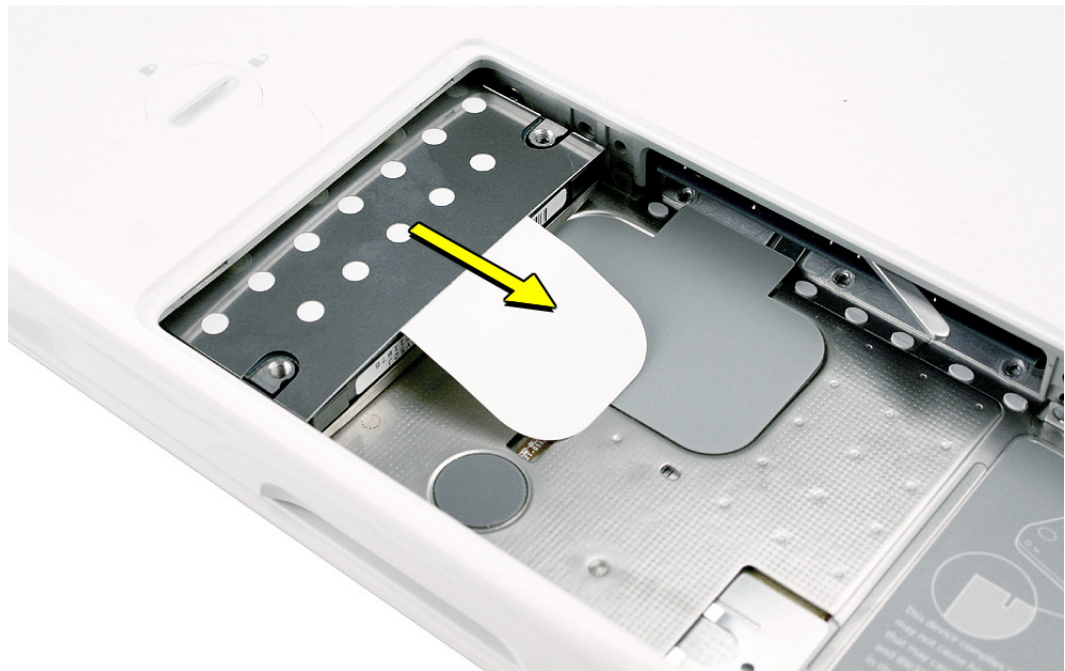

3. Hold the drive only by the sides when removing and replacing it.



4. Install the replacement hard drive, and reassemble and test the computer.

**Important:** After a new hard drive replacement, you must update the operating system to Mac OS X version 10.5 or later.

**Replacement Note:** If you are installing the hard drive while the top case is off, make sure the bottom case spring guide, shown below, is aligned with the notch in the bottom case.

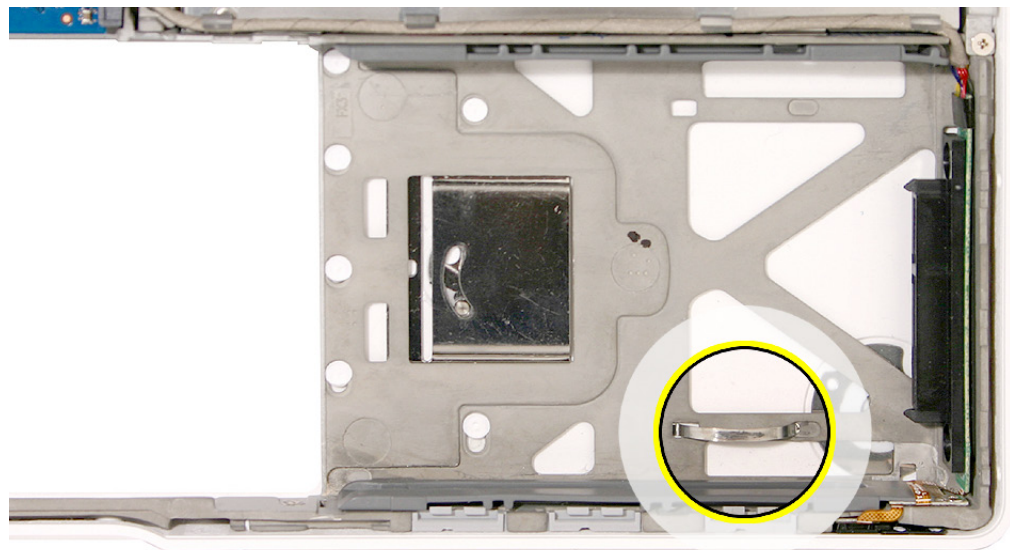



## Top Case (with Keyboard)

### Tools

- ESD wrist strap and mat
- Magnetic Phillips #0 screwdriver
- Magnetic Phillips #00 screwdriver (preferably with a long handle)
- Black stick (Apple part no. 922-5065) or other nonconductive nylon or plastic flatblade tool
- Access card (Apple part no. 922-7172) to open the top case
- Clean, soft, lint-free cloth

### Preliminary Steps

Before you begin, remove

- [Battery](#)
- [RAM door](#)

### Part Location



## Procedure

**Caution:** To prevent scratches or other cosmetic damage to the computer housing, use a soft cloth as a protective layer when removing and installing the external screws.

1. With the computer upright, remove the two identical 5.5-mm long shoulder screws from the right side of the computer.

**Replacement Caution:** When installing these top case screws, do not press on the area over the slot drive. The slot-drive bezel could be damaged with too much pressure.



2. **Important:** Notice the two screws at the left side of the computer. Although they can be removed, they exist for cosmetic purposes only and do not require removal. If they are removed, however, be sure to reinstall the two identical 3-mm long shoulder screws at the corner near the ports. Do not use longer screws.



3. At the back of the computer, remove the four #0 Phillips screws (two at each side) near the display hinge--
  - Two 12-mm long shoulder screws that are closest to the hinge
  - Two 8-mm long shoulder screws at the back corners of the computer



---

Turn over the computer, and on the outside of the bottom case, remove the three #0 Phillips screws:

- Two 14-mm long screws near display hinge
- One 11-mm long at center of bottom case

**Note:** If the two 14-mm screws are tightly wedged in their holes, gently turn the unit over and use your fingernails or a sharp black stick to pry them out, being careful not to damage the cosmetic casing.

**Replacement Caution:** Do not put one of the longer screws in the center screw hole or it will damage the logic board.

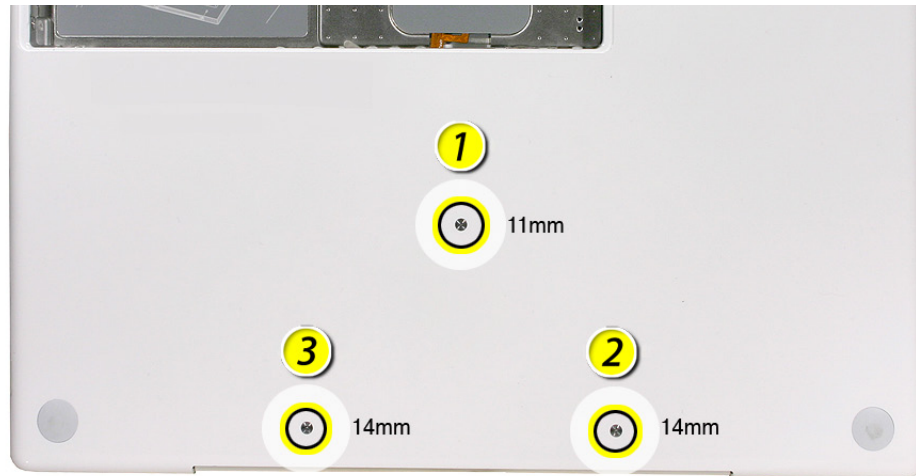

**Replacement Caution:** When installing the three bottom case screws, install them in the order shown.

4. Notice the long row of #0 Phillips screws at the front edge of the battery bay.
5. **Important:** Remove only the four screws shown. Remove the 3-mm long identical screws as follows:

Starting at the corner closest to the battery connector, skip the first screw, then remove the second, fourth, seventh, and ninth screw.

**Tip:** To help remember the screw sequence, think of it as “2, 4, 7, 9 loosens the top case every time.”

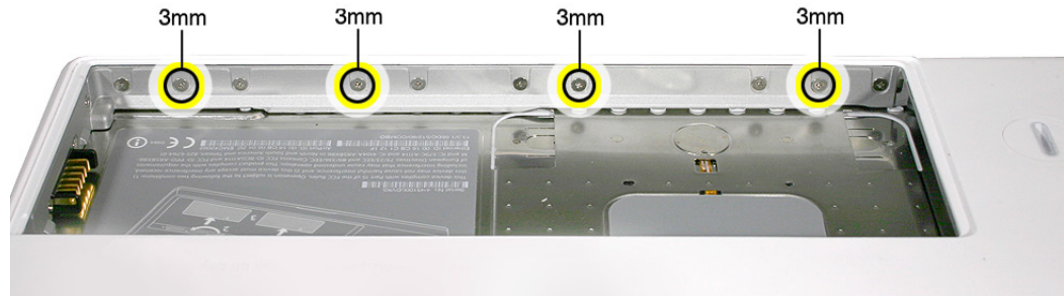

6. In the battery bay, remove the two 6-mm long identical screws that are on both outer sides of the battery connector. Do not remove the two screws that are closest to the battery connector.



7. In the battery bay, use a long-handled screwdriver to remove the three #00 Phillips screws at the inner edge of the battery bay near where the RAM slots are located:
  - Two identical 3-mm long screws
  - One longer 4.5-mm long screw at the corner of the battery bay nearest the battery connector

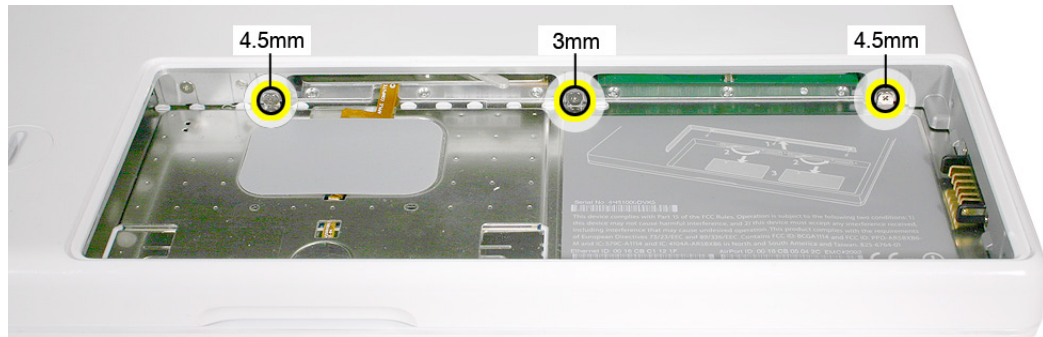

Because this is a recessed area, the screwdriver has to go in at an angle. Keep the screwdriver in line with the screw head as much as possible, especially to avoid stripping the screws.

**Replacement Caution:** When installing these three screws, an incorrect installation could cause the reassembled computer to wobble in use. To prevent a wobble symptom, use light pressure to hold the top case onto the assembly when installing the screws.

8. Open the display to a 90-degree angle or wider.
9. **Warning:** Inserting a tool too far or performing this step too quickly could break some of the snaps that secure the top case. Be especially careful with the left front corner of the top case. Starting at the left corner and working in a counter-clockwise direction, use an access card tool to open the gap along the front of the top case, around the perimeter, and to the right side above the optical drive slot.



- 
10. With the top and right side gap opened, tilt up—but do not remove—the right edge of the top case. This motion releases the remaining snaps between the top case and bottom case, and the slot-load bezel clips become loose as the top case is tilted up.



- 
11. Without straining the trackpad cable, carefully lift up the top case so you can see where the folded trackpad flex cable attaches to the logic board.



12. Use the flat end of a black stick to reach in and disconnect the trackpad cable.



13. Lift the top case up and away from the computer assembly.

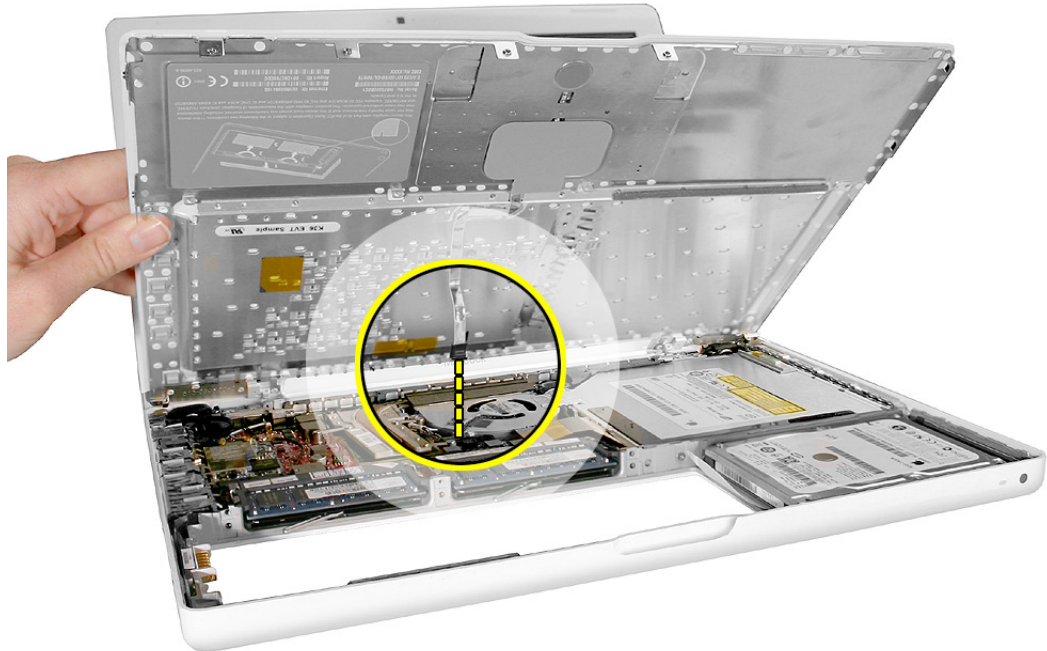

14. Refer to the following notes to install the replacement top case, and reassemble and test the computer.



---

**Replacement Note:** The top case includes heatstaked keyboard, webbing, EMI shield, and attached trackpad cable.

**Replacement Note:** Before replacing the top case, make sure to connect the trackpad flex cable to the logic board.

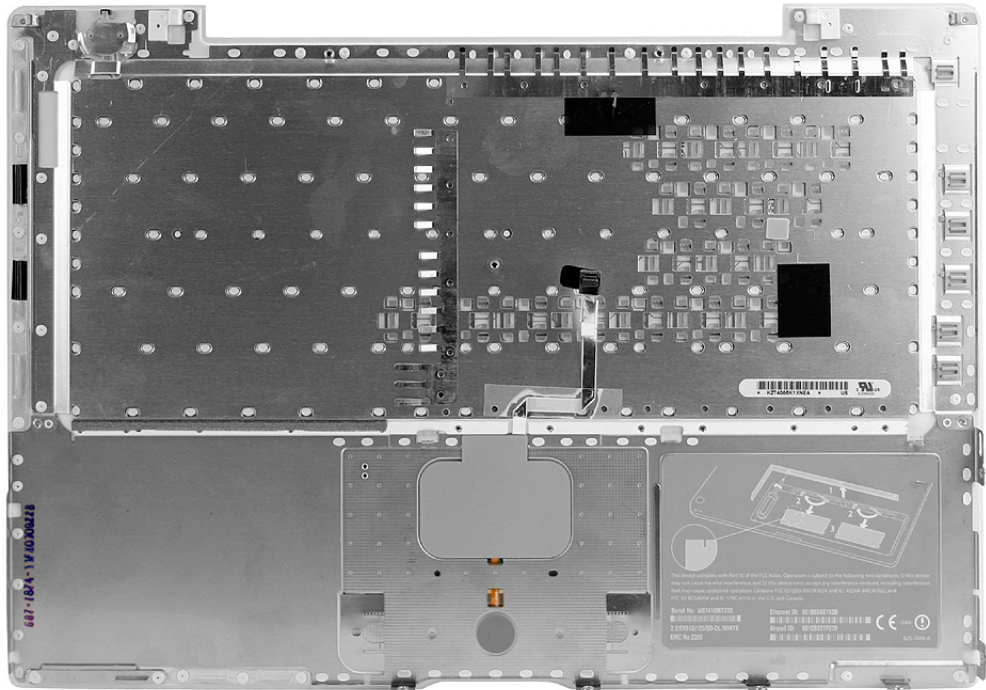

---

**Replacement Note:** Install the right side of the top case first (near the disc bezel). Then starting from the right, secure the snaps by pressing along the outer edge of the top case in a clockwise direction around the front and left side of the top case.

**Replacement Caution:** When installing exterior and battery bay screws, apply light pressure to the top case to ensure that the top case fits to the bottom case without any gaps.

**Replacement Note:** Pinch the top case to the bottom case as you secure the screws.

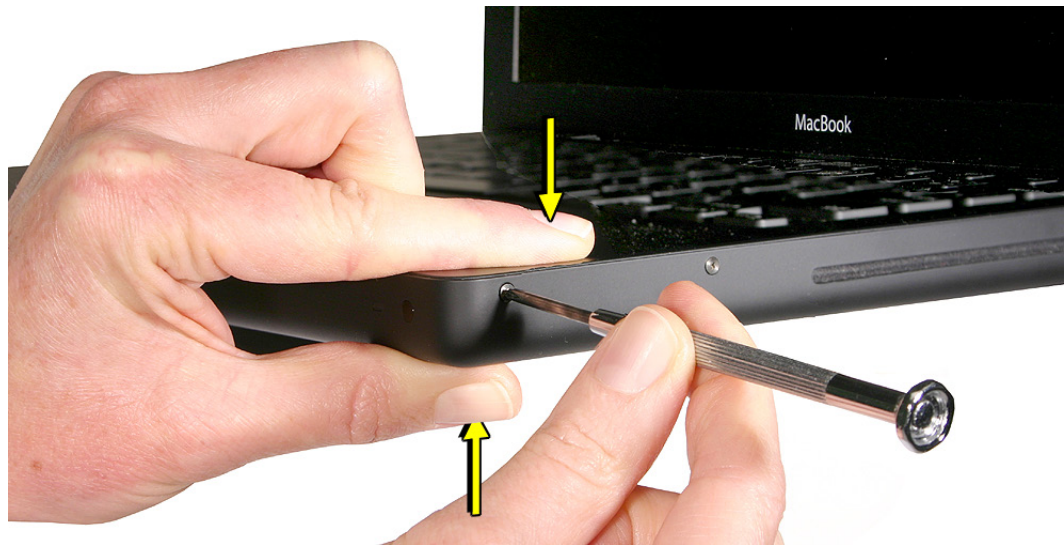

**Replacement Note:** When installing the screws at the rear corners of the bottom case, insert an access card tool between the top case and the display to maintain light pressure as the screws are tightened.





## Top Case/Display Bezel Kit

### New Kit Available in July 2010

A new kit is available for top case replacement in the U.S. The kit contains:

- top case with keyboard
- display bezel

### Before Ordering Parts

When replacing a top case or display bezel, order the new kit to replace both parts in one repair.

Old Part Number	New Kit Part Number
661-5060 top case with keyboard	922-9550 top case with keyboard and display bezel
922-8383 display bezel	bezel

The Take Apart instructions are unchanged for

- Top Case with Keyboard
- Display Bezel

### Note About International Parts

Check the Service Parts Database (GSX) for international kit part numbers (with language-specific keyboards) coming soon.



# Trackpad Cable

## Tools

- ESD wrist strap and mat
- Black stick (Apple part no. 922-5065) or other nonconductive nylon or plastic flatblade tool

## Preliminary Steps

Before you begin, remove

- [Battery](#)
- [RAM door](#)
- [Top case with keyboard](#)

## Part Location

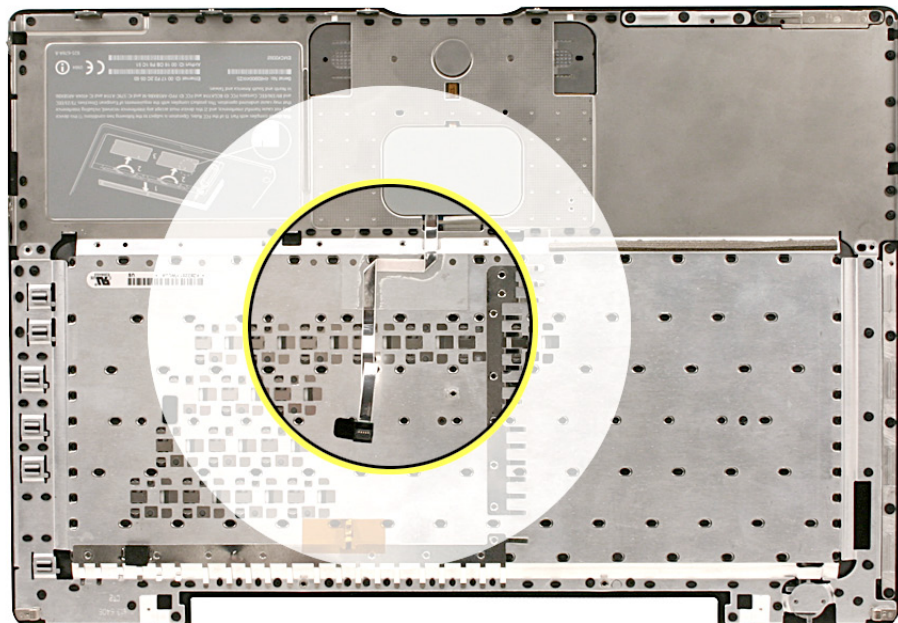

---

## Procedure

1. Place the top case (keyboard side down) on a clean surface.

**Replacement Note:** The folds in the trackpad cable and the areas that adhere to the top case should match the computer you are servicing; however, the cable on your computer might be slightly shorter.

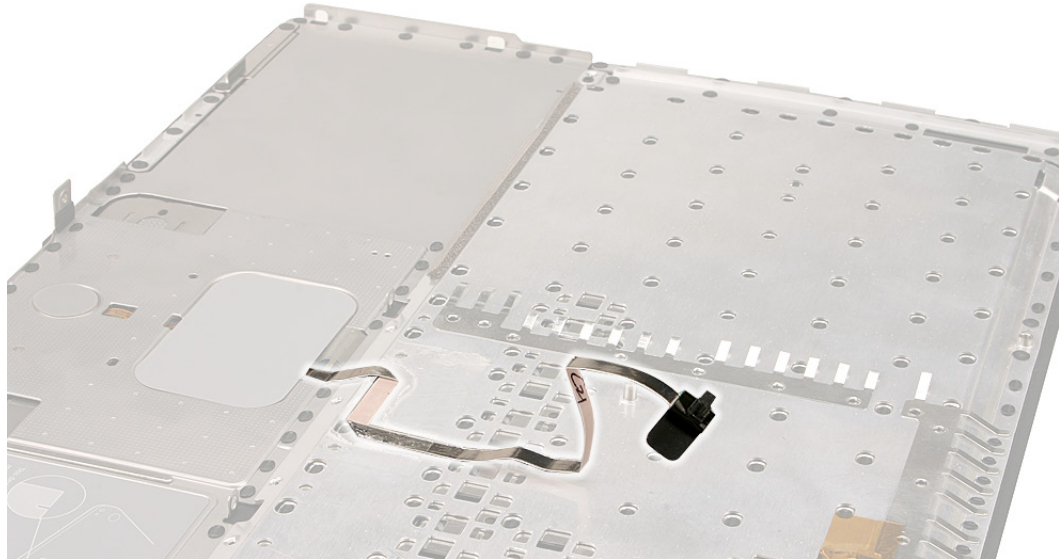

2. Use a black stick to start to peel up the clear strip of tape.

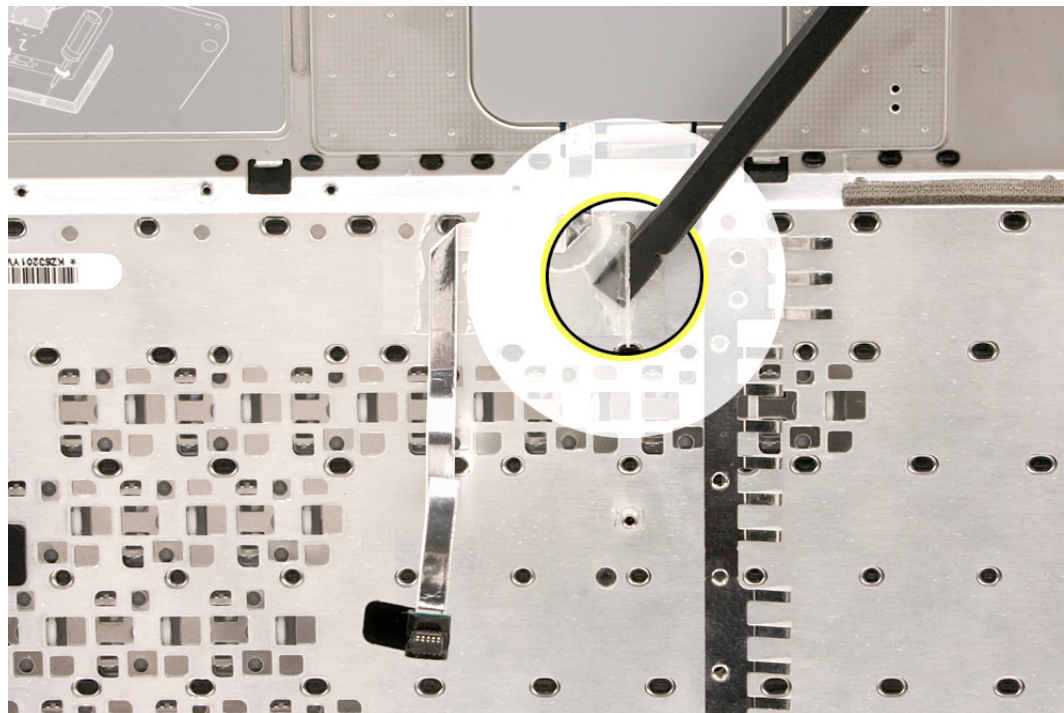

3. Hold the trackpad cable in place as you peel up—but do not remove—the tape.

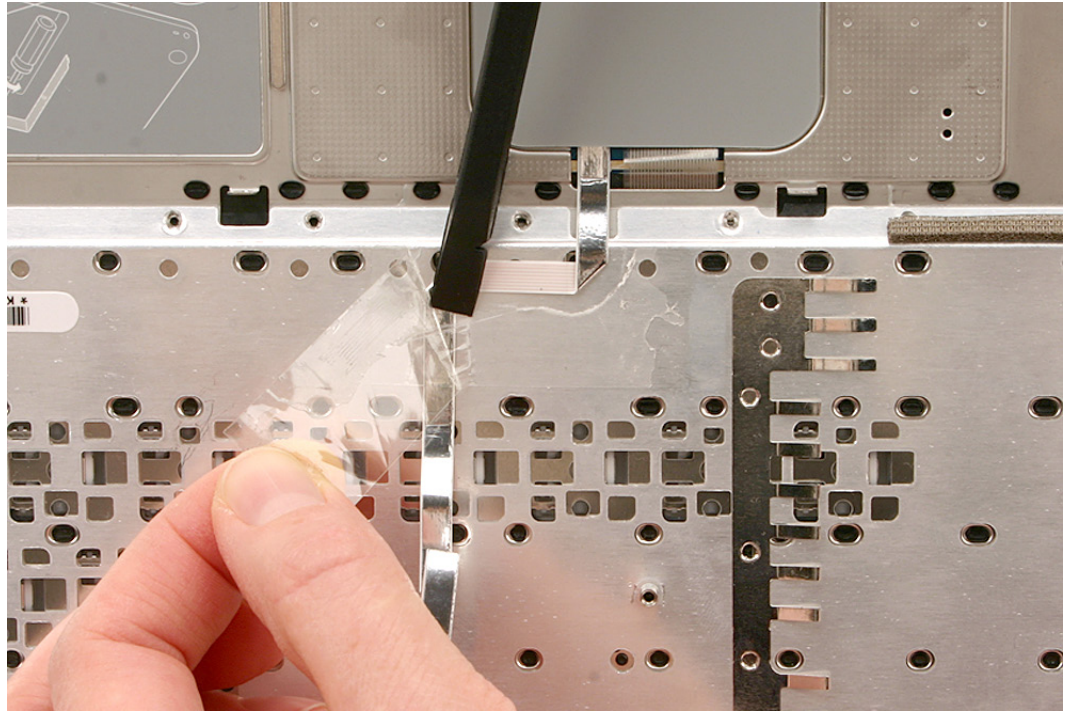

4. Peel up the mylar shield that protects the trackpad circuitry.

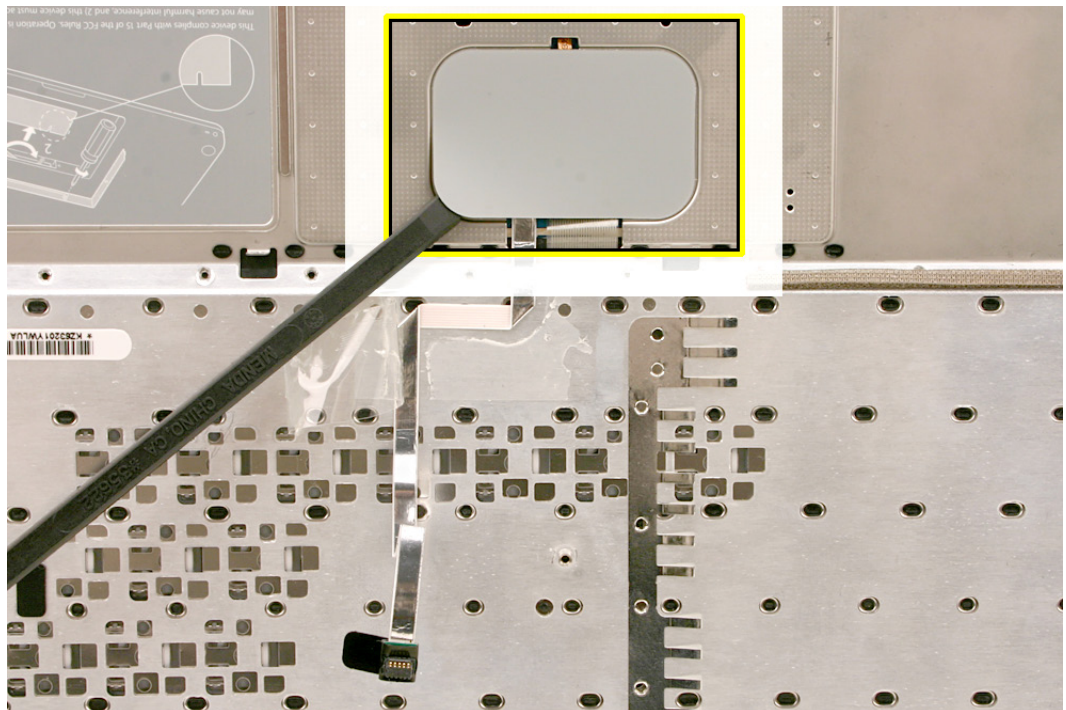

**Note:** The shape of the mylar shield may differ slightly. This one includes a squared-off tab:

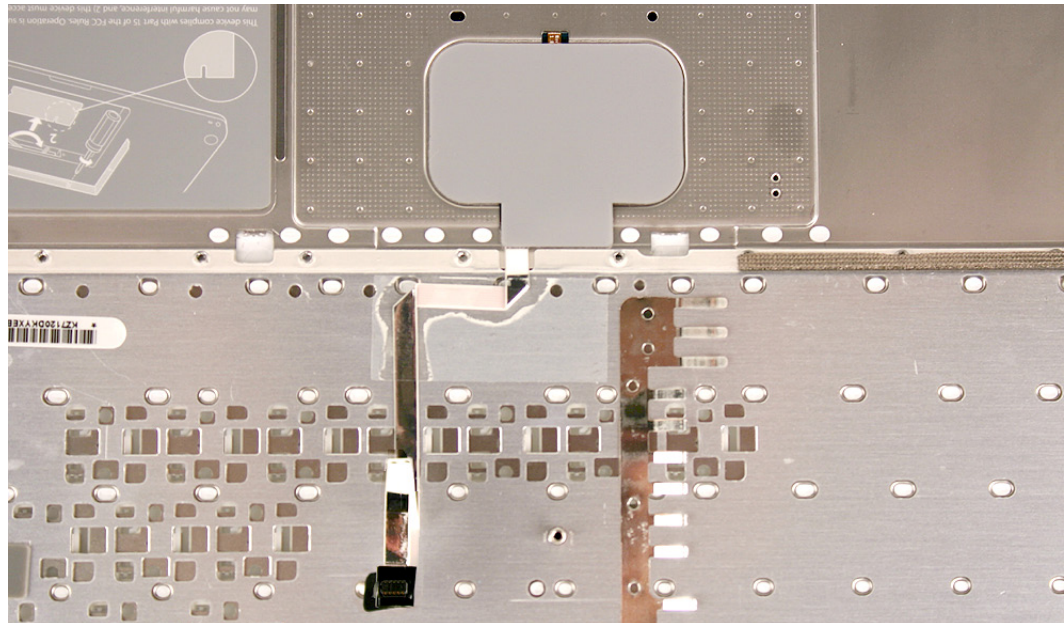

5. **Caution:** The trackpad cable locking lever at the top of the connector is fragile. Use a black stick to carefully tilt up the lever until it is vertical (as shown by the detailed image on right).  
**Replacement Note:** When locking the trackpad cable lever, make sure it is completely closed, as shown by the detailed image on left below.

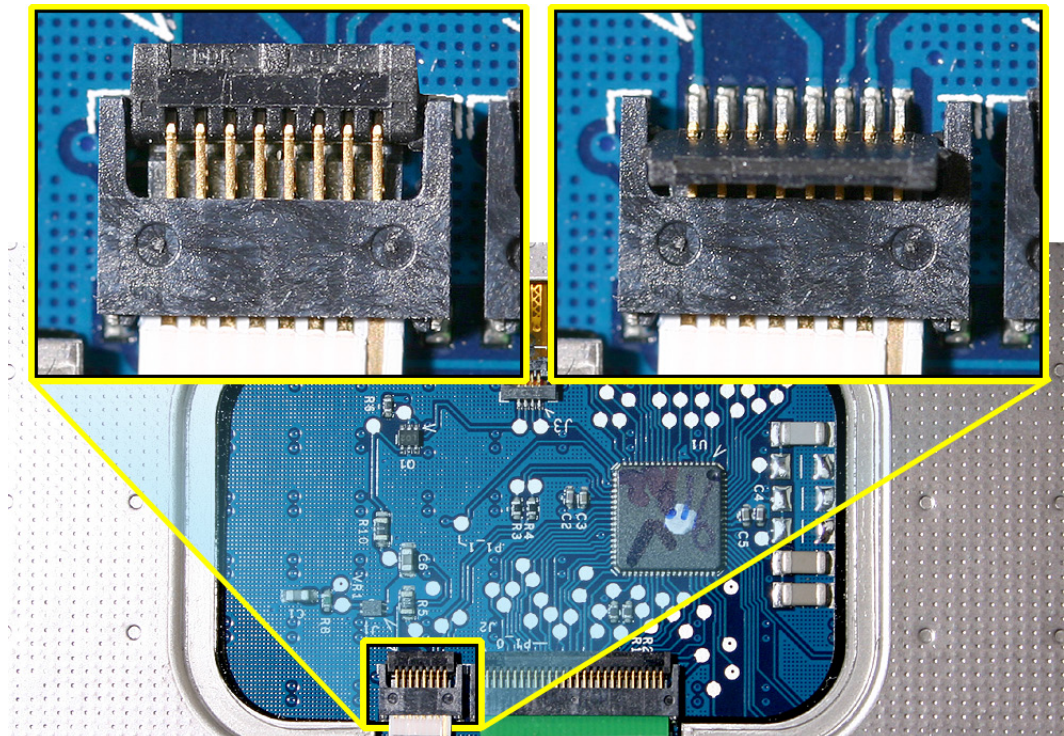

6. With the cable locking lever open, pull the cable down to remove it from the connector.
7. Carefully peel up the trackpad cable from where it adheres to the underside of the top case.

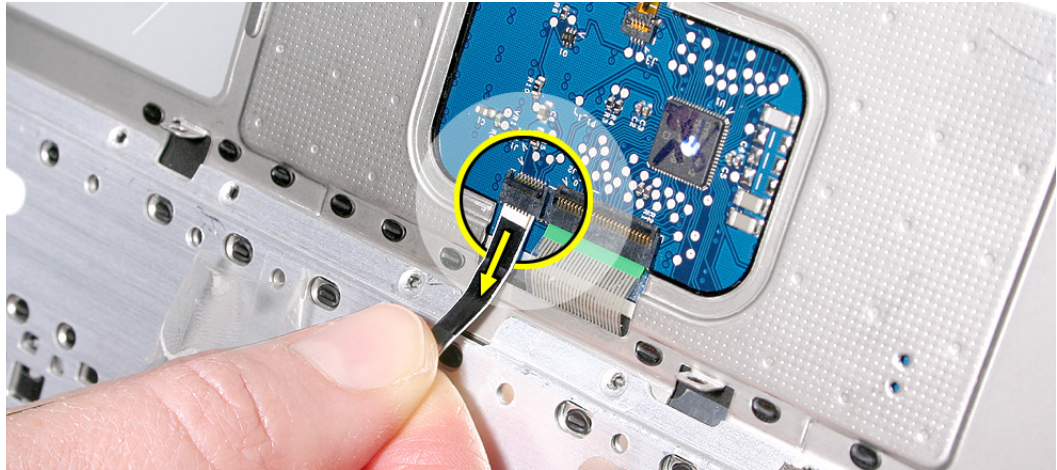

8. Install the replacement trackpad cable, and reassemble and test the computer.

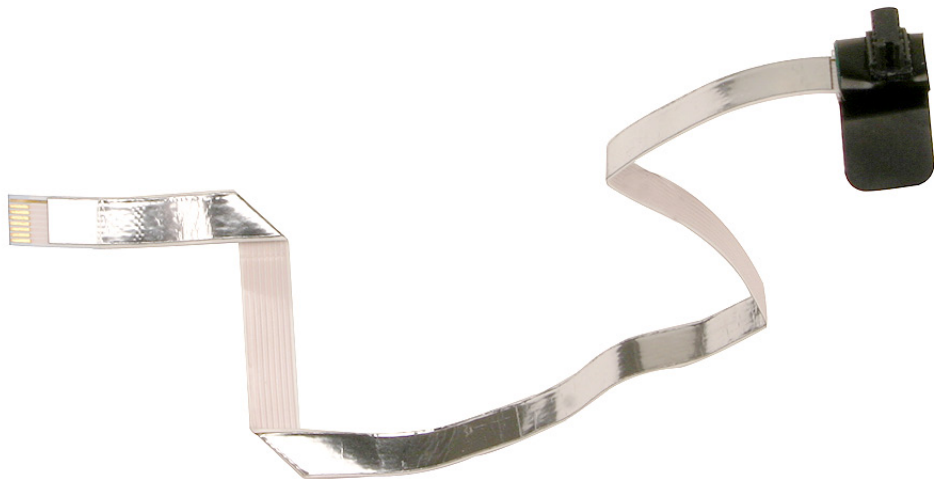



## Hard Drive Snubbers, Front and Rear

### Tools

- ESD wrist strap and mat
- Black stick (Apple part no. 922-5065) or other nonconductive nylon or plastic flatblade tool
- Permanent-marking, felt-tip pen
- Magnetic Phillips #0 screwdriver (for rear snubber only)

### Preliminary Steps

Before you begin, remove

- [Battery](#)
- [RAM door](#)
- [Top case with keyboard](#)
- [Hard drive](#)

### Part Location

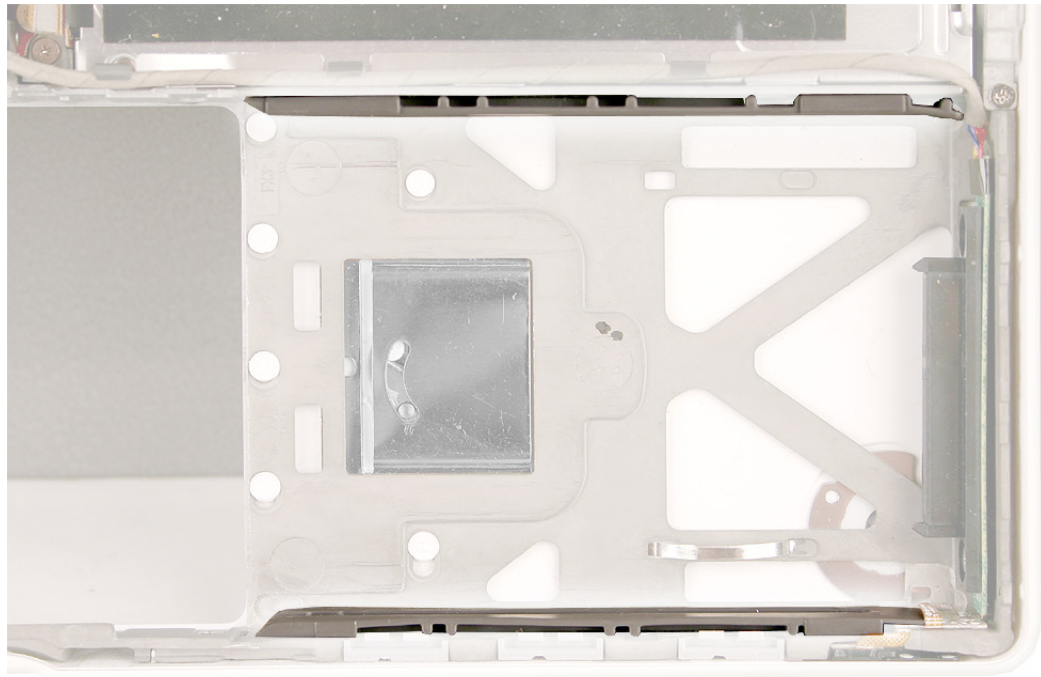

---

## Procedure

**Caution:** The two hard drive snubbers are held in place on the bottom case frame with adhesive. When replacing the snubber(s), avoid touching the optical drive or the hard drive connector.

### Replacing the Front Snubber

1. Use a fine-point permanent marker to lightly mark the inside of the bottom case frame where the snubber begins and ends.



2. Starting at the end of the snubber that is farthest from the hard drive connector, use a black stick to peel off the snubber.
3. If necessary, use a needlenose pliers or tweezers to remove remaining pieces of rubber that stick to the bottom case. Clean the area if necessary.
4. Peel off the paper backing from the new front snubber, and press it into place between the two pen marks.



5. Test that the hard drive easily slides into and out of the drive bay.

---

## Replacing the Rear Snubber

1. Use a fine-point permanent marker to lightly mark the inside of the bottom case where the snubber begins and ends.
2. Remove only the 4.5-mm long screw (not the 3.5 mm screw) at the optical drive.

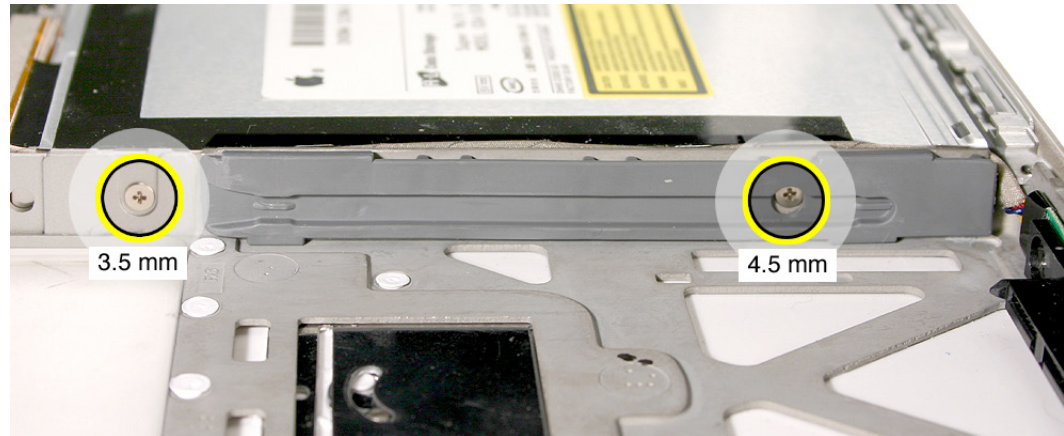

3. Starting at the end of the snubber that is farthest from the hard drive connector, use a black stick to peel off the snubber.
4. If necessary, use a needlenose pliers or tweezers to remove remaining pieces of rubber that stick to the bottom case. Clean the area if necessary.
5. Peel off the paper backing from the new rear snubber, and align the screw hole first. Then press the snubber into place between the two pen marks.
6. Install the 4.5-mm long screw, and test that the hard drive easily slides into and out of the drive bay.
7. Reassemble and test the computer.



# AirPort Extreme Card

## Tools

- ESD wrist strap and mat
- Black stick (Apple part no. 922-5065) or other nonconductive nylon or plastic flatblade tool
- Magnetic Phillips #0 screwdriver

## Preliminary Steps

Before you begin, remove

- [Battery](#)
- [RAM door](#)
- [Top case with keyboard](#)

## Part Location

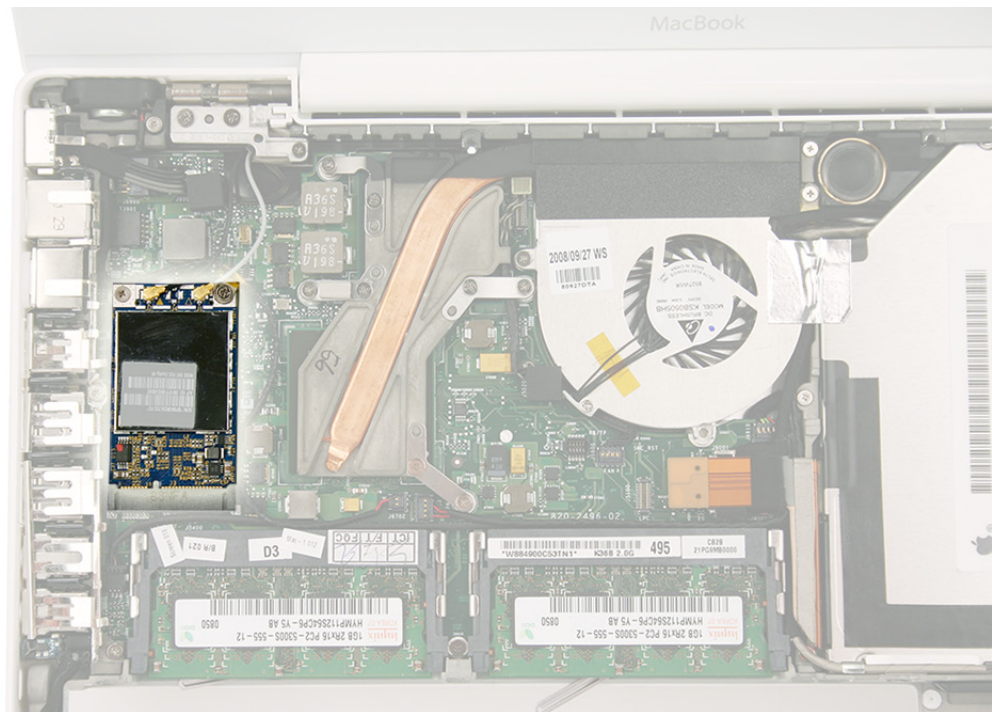

## Procedure

**Caution:** When servicing the computer, be especially careful when working near the spring on the logic board. Although the spring is flexible, it can be inadvertently torn, bent, or broken if a cable gets caught on it. A logic board might be considered unusable with a damaged spring. Check the structural integrity of the spring before completing a repair.

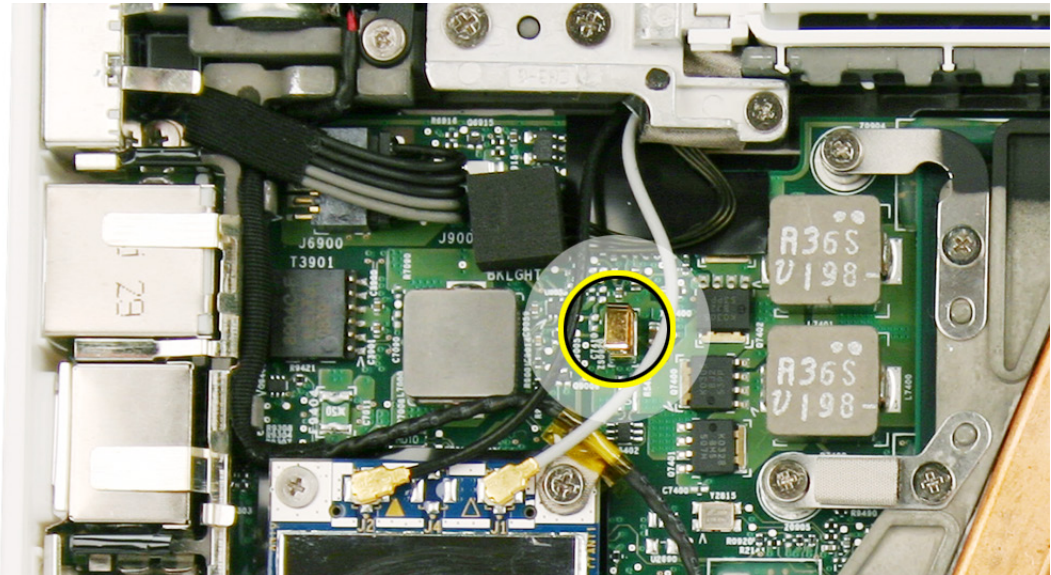

1. Remove the 8.5-mm long screw (that also functions as the left speaker cable ground pin) from the upper right corner of the card. (The thick head on this screw helps identify it.)
2. Remove the 3.5-mm long screw from the upper left corner of the AirPort card.

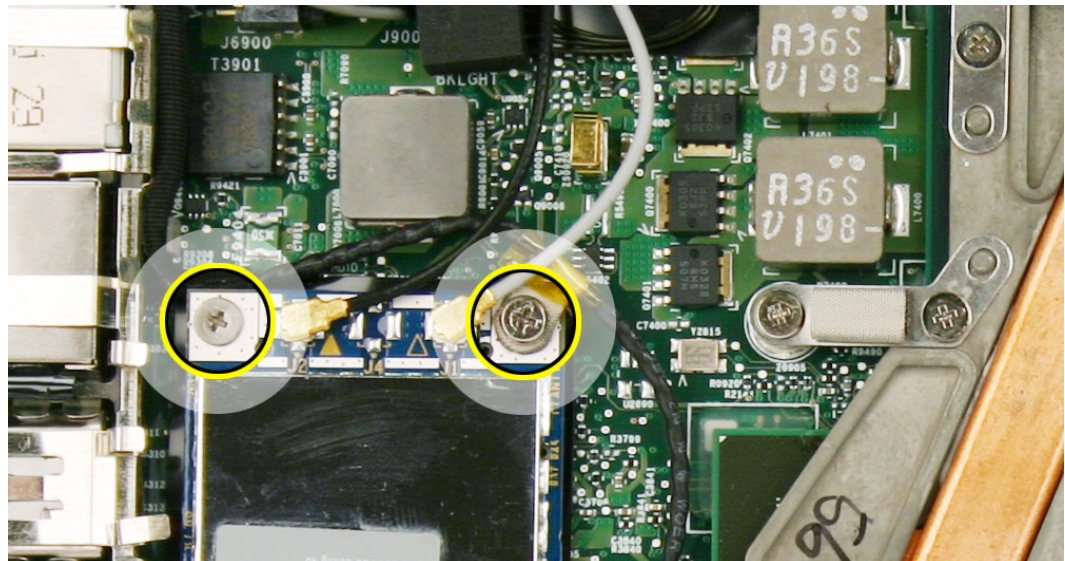

3. Set aside the speaker ground cable flange, disconnect the two antenna cables, and pull the

card up and out of the card socket on the logic board.

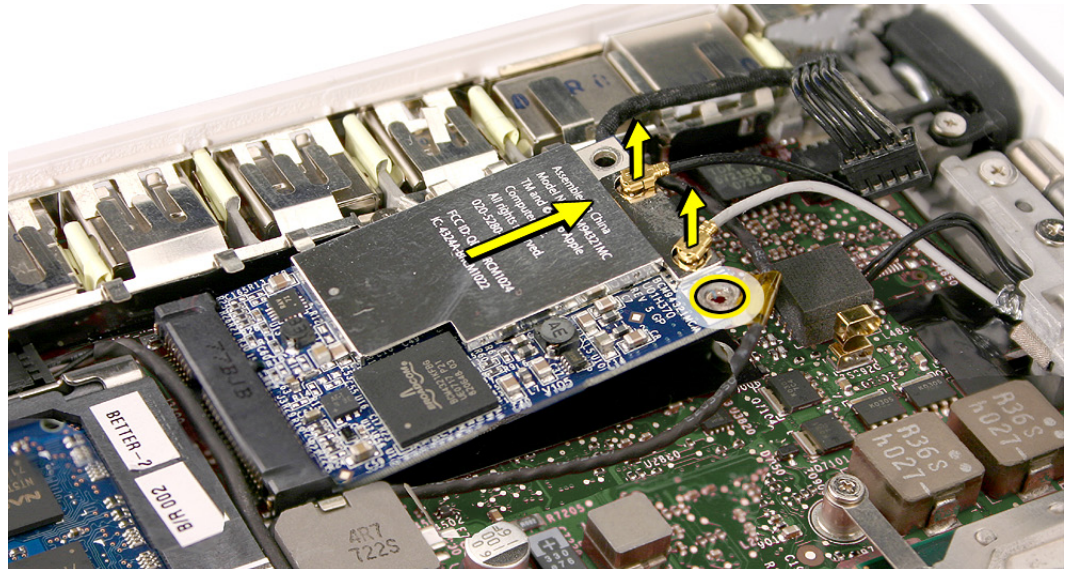

4. Install the replacement AirPort Card, and reassemble and test the computer.

**Replacement Caution:** When connecting the AirPort antenna cables, make sure the cables do not obstruct the gold spring on the logic board. If one of the cables were caught in the folds of the spring, the cable or spring could be damaged when the top case is installed.

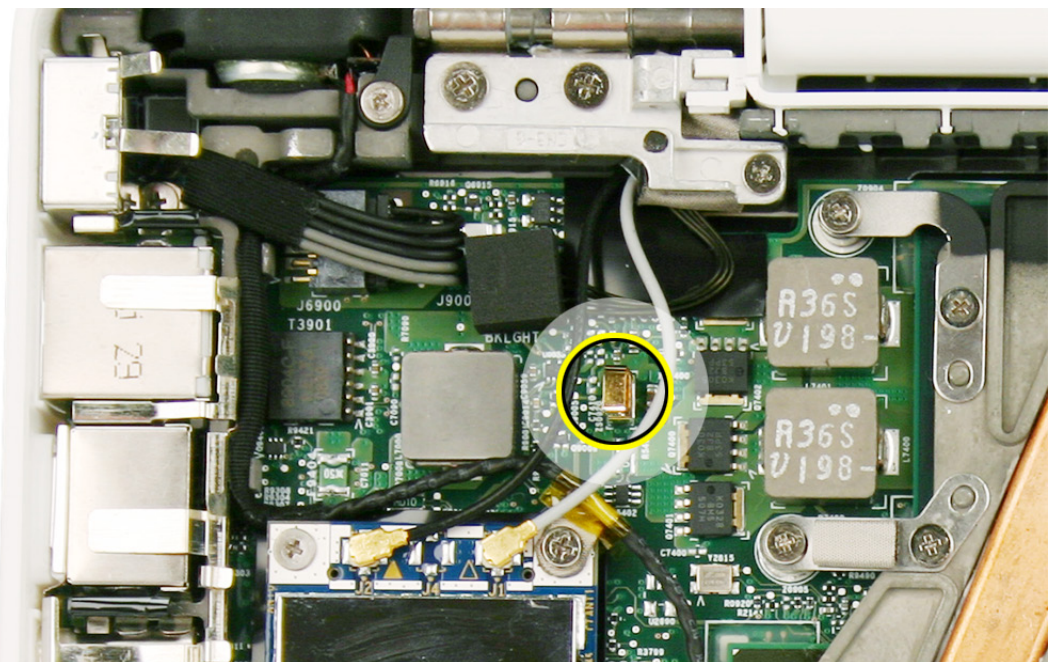



# MagSafe DC-In Board

## Tools

- ESD wrist strap and mat
- Magnetic Phillips #0 screwdriver
- Black stick (Apple part no. 922-5065) or other nonconductive nylon or plastic flatblade tool

## Preliminary Steps

Before you begin, remove

- [Battery](#)
- [RAM door](#)
- [Top case with keyboard](#)

## Part Location



## Procedure

1. Place a black stick under the DC-in connector cables to help disconnect the connector, then pull the connector away from its connection on the logic board.



2. Remove the 3-mm long screw from the MagSafe DC-in board.

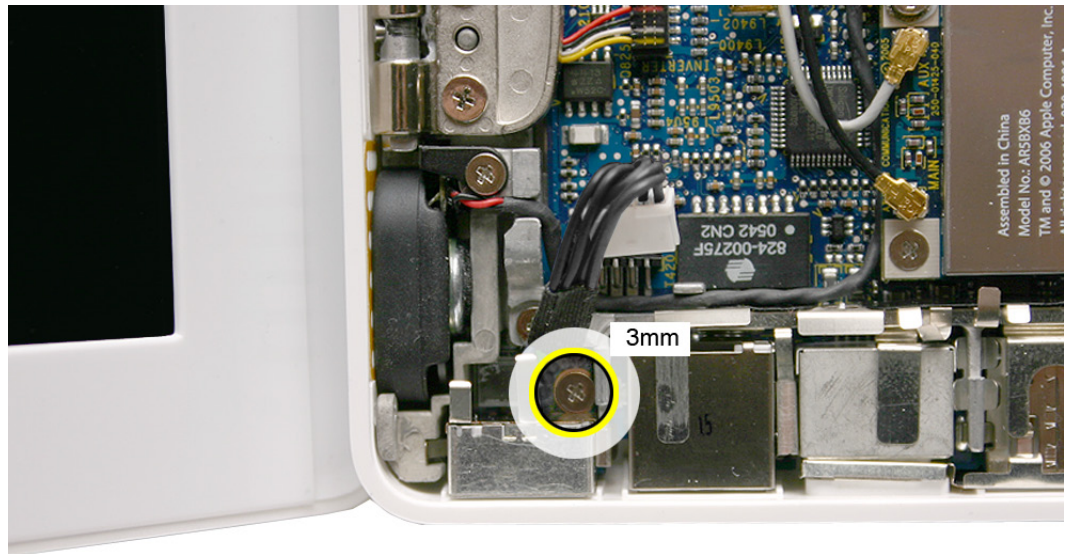

**Caution:** The MagSafe DC-in port is magnetic. Be careful that it doesn't pick up screws or other small metallic parts.

- From the port side, use a black stick to help tilt up the MagSafe DC-in board as shown, then extract it out from under a lip on the logic board, pulling straight out at an upward angle.

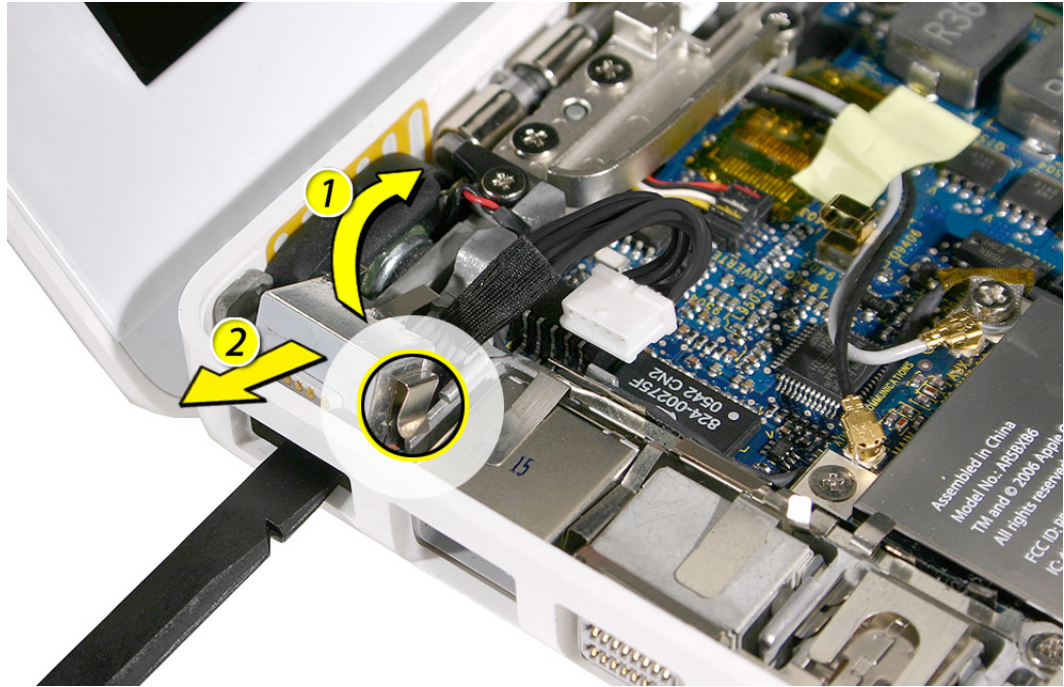

**Replacement Note:** Make sure the folded side of the EMI shield fits over the I/O frame rib so that the rib is sandwiched between the flanges of the EMI shield.

**Replacement Note:** If installing a new MagSafe DC-in board, first peel off the protective membrane from the MagSafe DC-in board. Then connect the DC-in cable to the connector on the logic board, and insert the board into the upper left corner of the bottom case. Finally, install the screw.

- Install the replacement MagSafe DC-in board, and reassemble and test the computer.

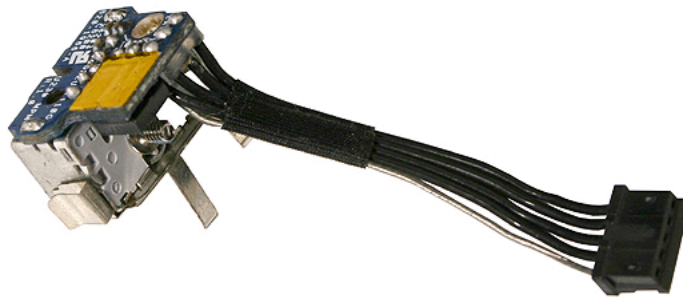

---

**Replacement Note:** Check that there are no bent EMI fingers on the shield covering the port area.

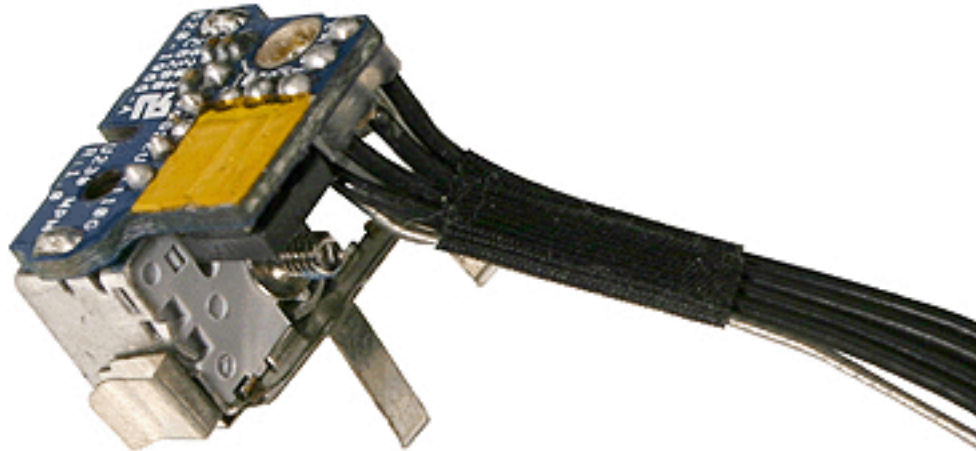

**Replacement Note:** Check the port side of the bottom case to make sure the MagSafe DC-in port is level with the port opening.





# Left Speaker

## Tools

- ESD wrist strap and mat
- Magnetic Phillips #0 screwdriver
- Black stick (Apple part no. 922-5065) or other nonconductive nylon or plastic flatblade tool

## Preliminary Steps

Before you begin, remove

- [Battery](#)
- [RAM door](#)
- [Top case with keyboard](#)

## Part Location

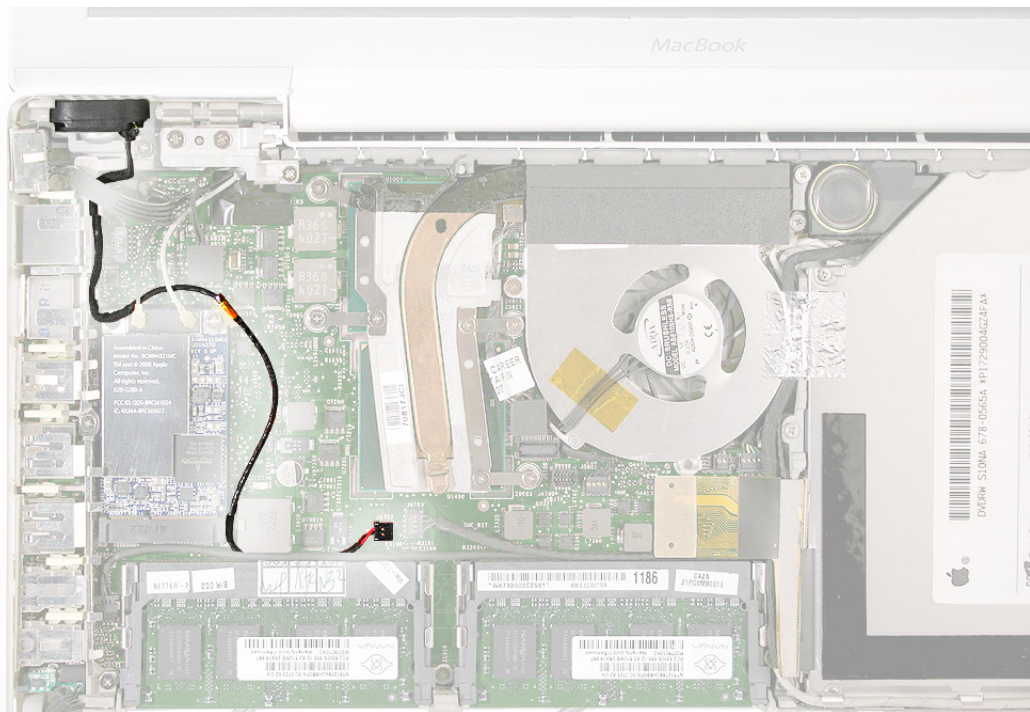

## Procedure

**Note:** Images shown below may differ from the actual computer you are servicing; however, the steps and sequence are the same.

1. Optional: Disconnect the MagSafe connector cable.
2. Remove the 8.5-mm long screw from the speaker body and the 8.5-mm long ground screw at the upper right corner of the AirPort Extreme Card.
3. Disconnect the speaker cable from the logic board.

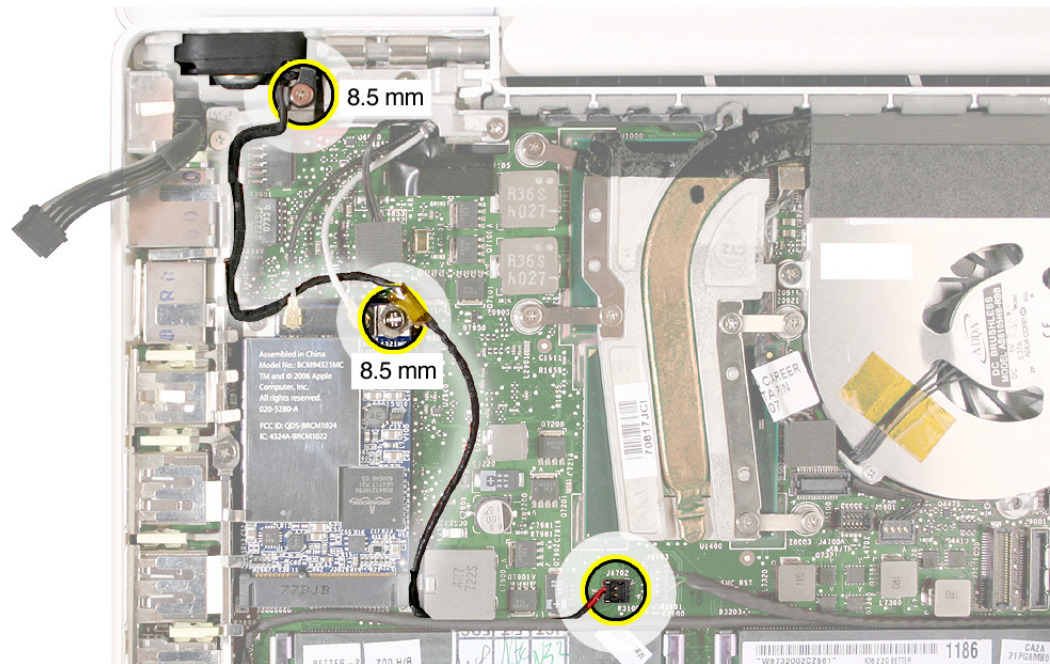

4. Route the disconnected speaker cable underneath the AirPort cables.

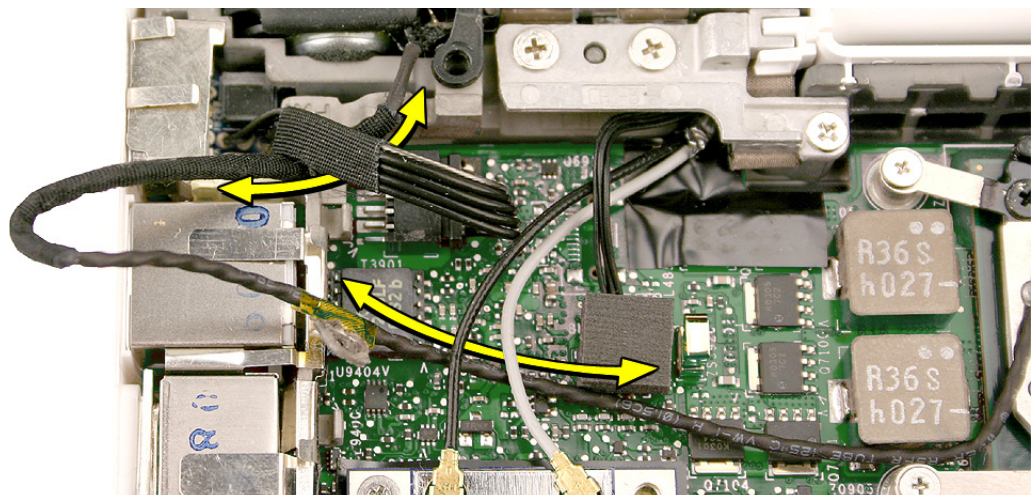

5. Tilt up the speaker from the bottom case, and route the cable underneath the MagSafe cable (if still connected).

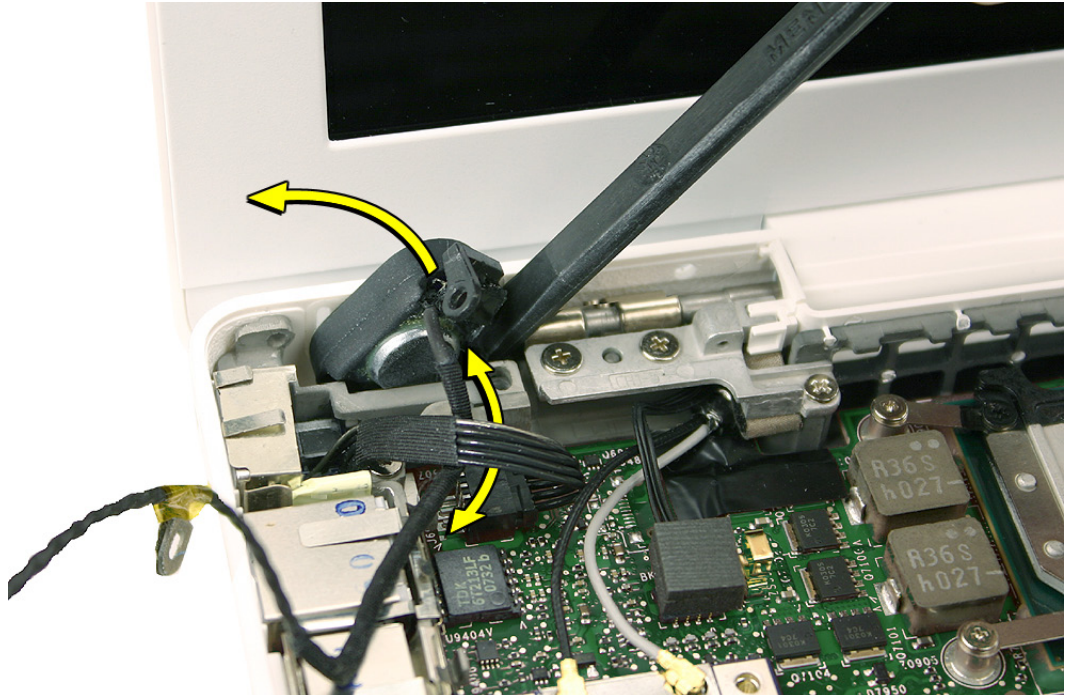

6. Install the replacement speaker cable, and reassemble and test the computer.  
**Replacement Note:** To prevent a pinched cable, make sure the cable is routed as shown.

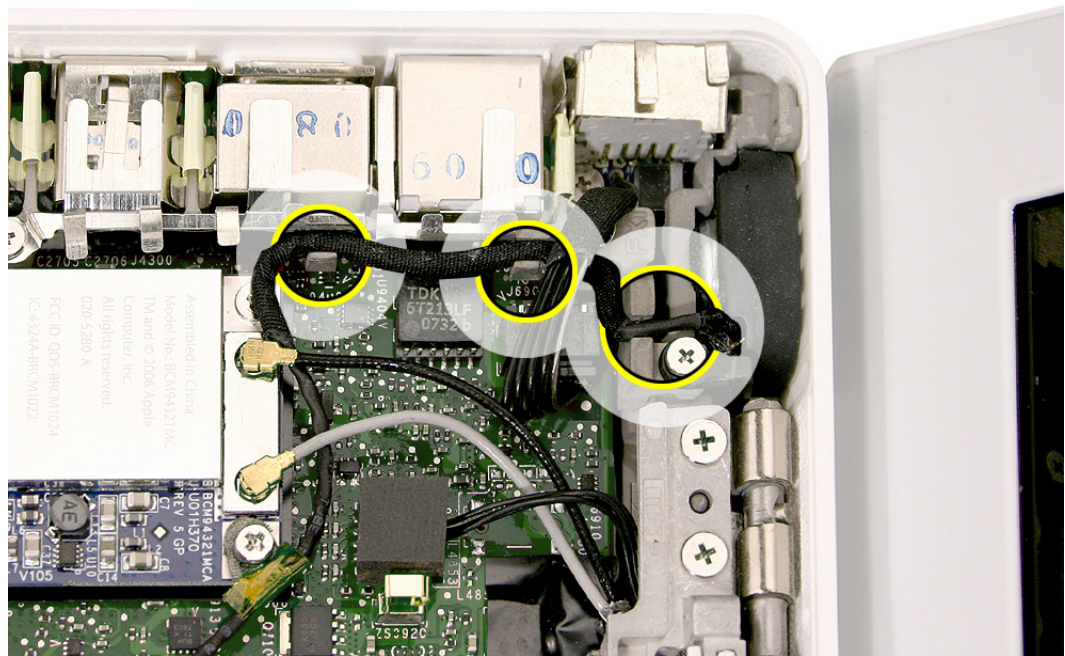



## I/O Frame (with upper EMI shield)

### Tools

- ESD wrist strap and mat
- Magnetic Phillips #0 screwdriver
- Black stick (Apple part number 922-5065) or other nonconductive nylon or plastic flatblade tool

### Preliminary Steps

Before you begin, remove

- [Battery](#)
- [RAM door](#)
- [Top case with keyboard](#)

### Part Location

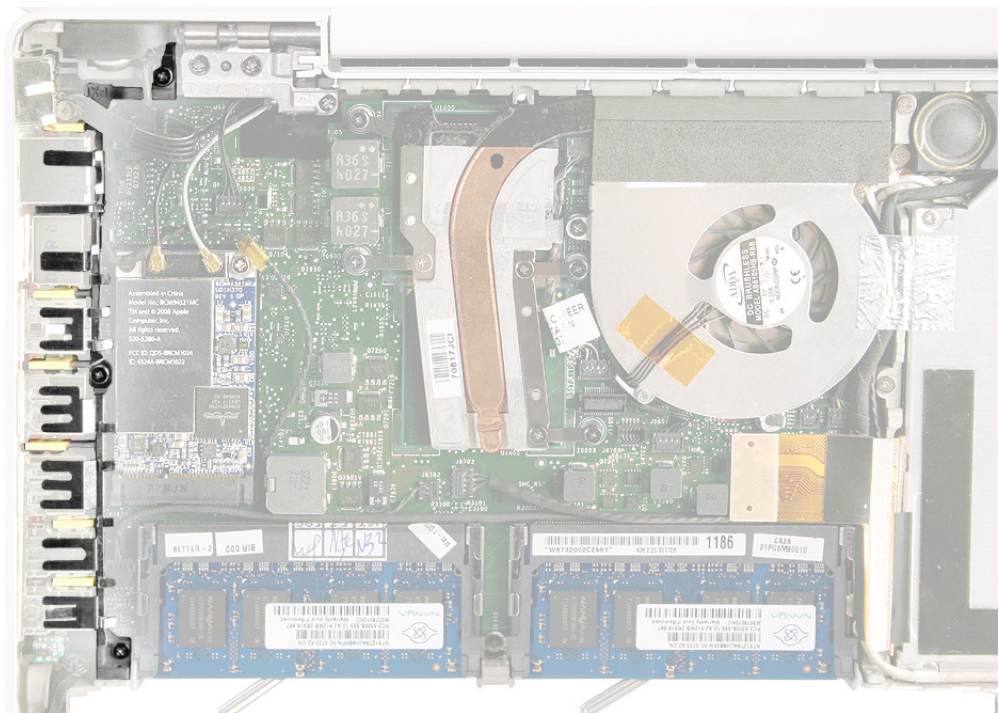

## Procedure

1. Disconnect the MagSafe connector from the logic board, and remove the four identical 8.5-mm long screws from the I/O frame.

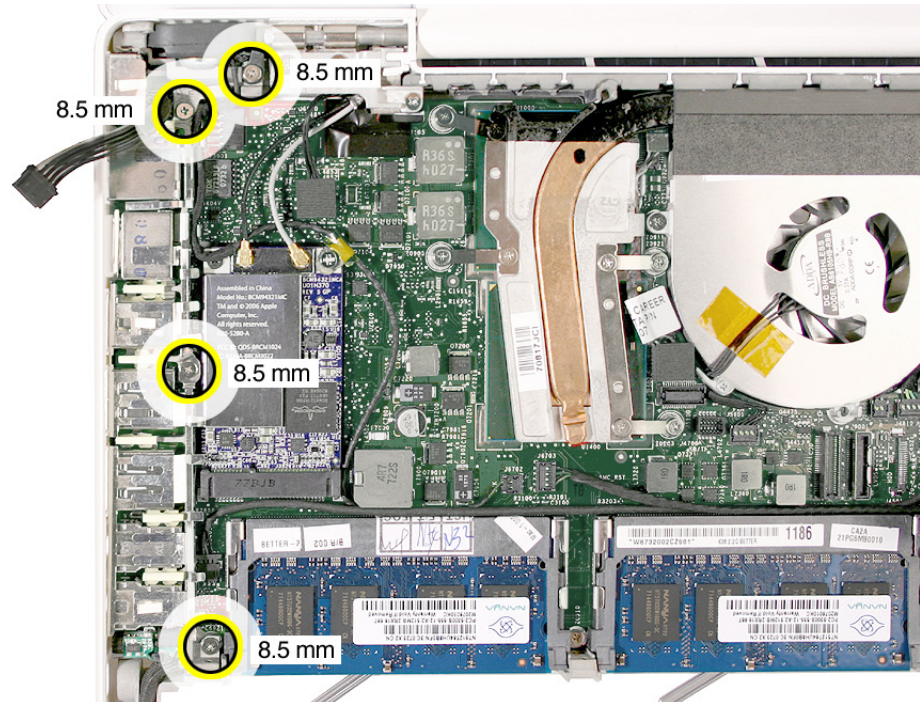

2. Note how the EMI shield on the I/O frame interlocks with the shield over the ports. Make sure that the shield does not stick to the ports when removing the I/O frame.
3. Tilt up the I/O frame to remove it from the computer assembly.

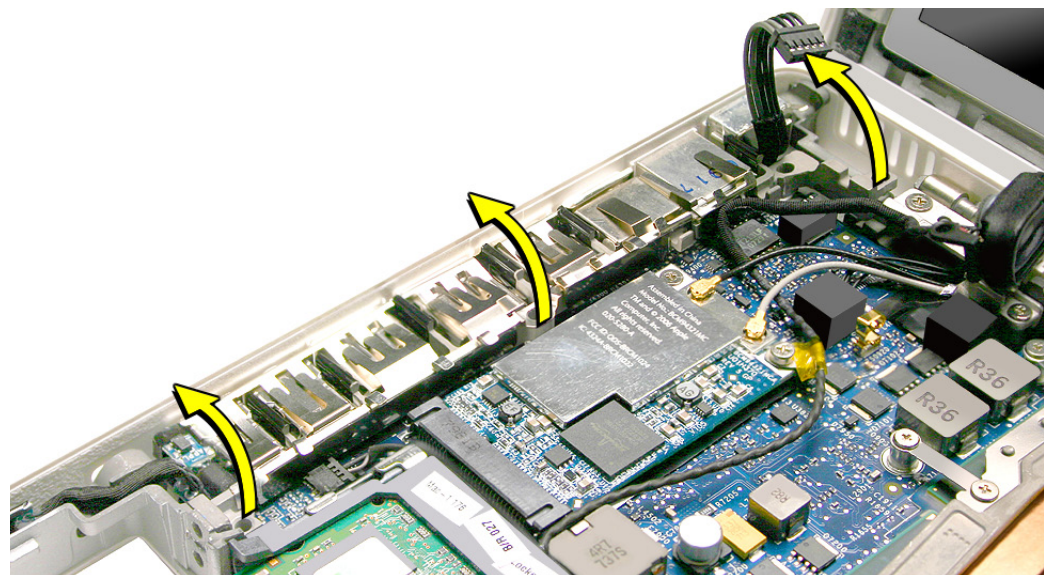

4. Note that the I/O frame includes the EMI shield. Be careful not to bend the shield as you remove or install it.

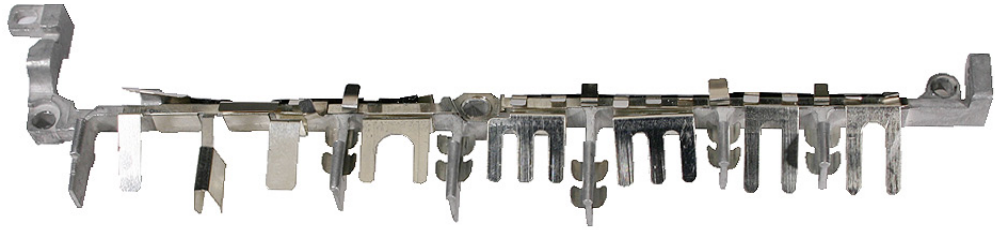

5. Install the replacement I/O frame, and reassemble and test the display.

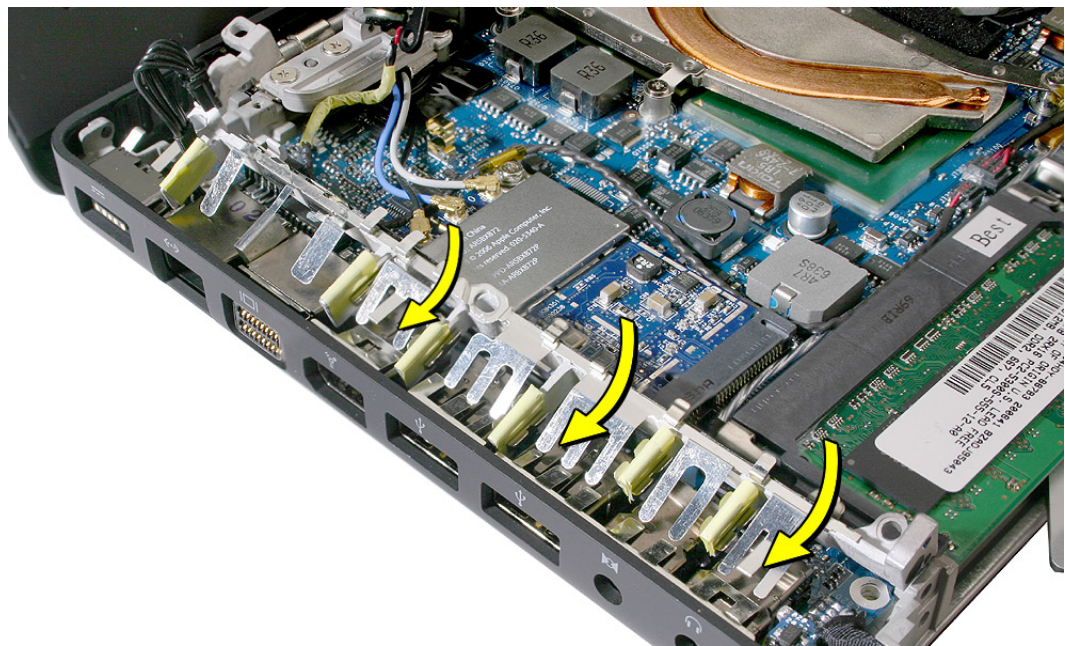



# Battery Connector with Sleep Switch

## Tools

- ESD wrist strap and mat
- Magnetic Phillips #0 screwdriver
- Black stick (Apple part no. 922-5065) or other nonconductive nylon or plastic flatblade tool

## Preliminary Steps

Before you begin, remove

- [Battery](#)
- [RAM door](#)
- [Top case with keyboard](#)
- [I/O frame](#)

## Part Location

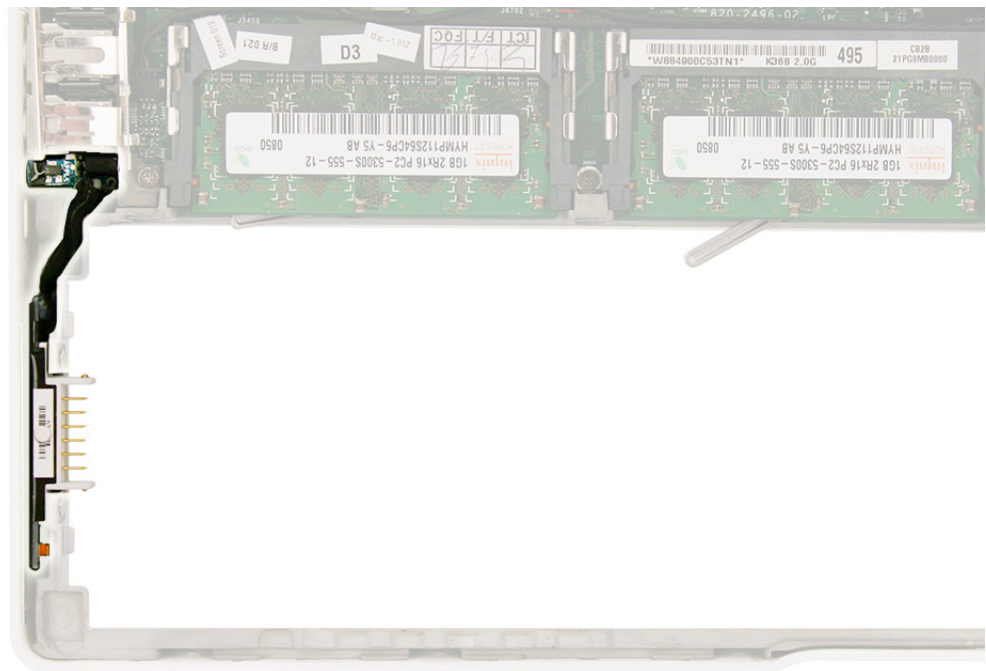

## Procedure

**Caution:** Do not touch the raised section of the sleep switch connector. It is quite fragile and could break.

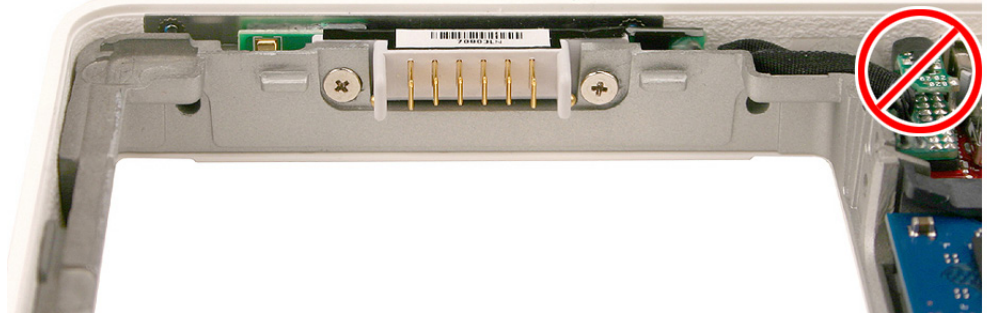

1. Remove the two 4.5-mm long shoulder screws from the frame at the battery connector.

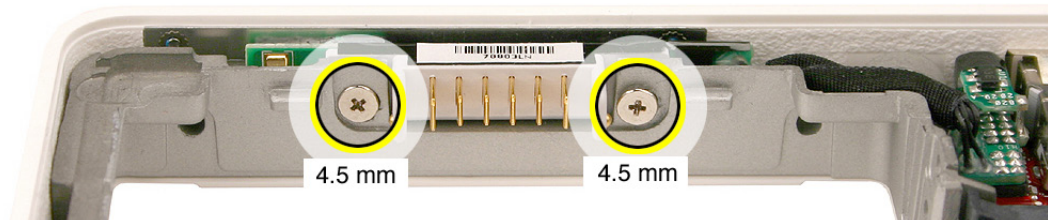

**Replacement Caution:** Make sure the screws are the proper length. A longer screw could damage the board.

2. Tilt up the battery connector end of the board.
3. Avoid touching the raised section of the sleep switch connector; it is fragile and could break. Insert a black stick under the cables, and lift up the connector from the logic board.

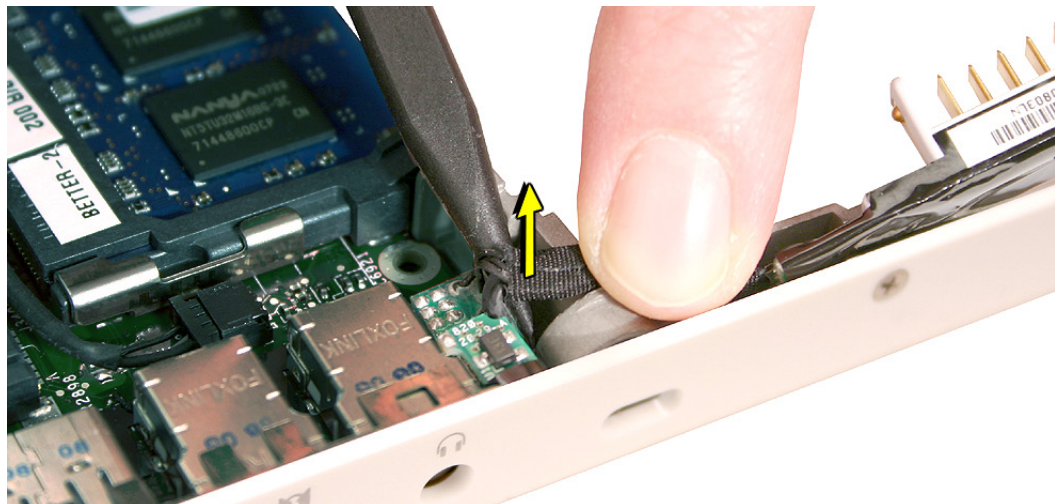

4. **Important:** When replacing the battery connector/sleep switch, make sure the arrangement of pins on the connector exactly match the pin openings on the logic board.

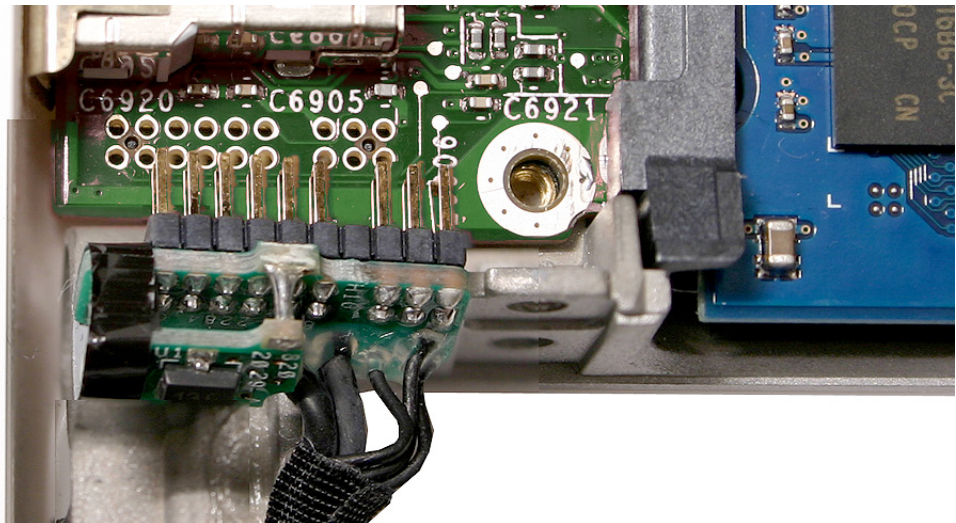

5. To avoid bending the pins on the sleep switch connector card, make sure you squarely align the pins over the logic board and keep the connector card level when installing it.
6. Install the “pins” end of the sleep switch connector first; then install the battery connector and screws. You may use a black stick to press on the lower end of the sleep switch.

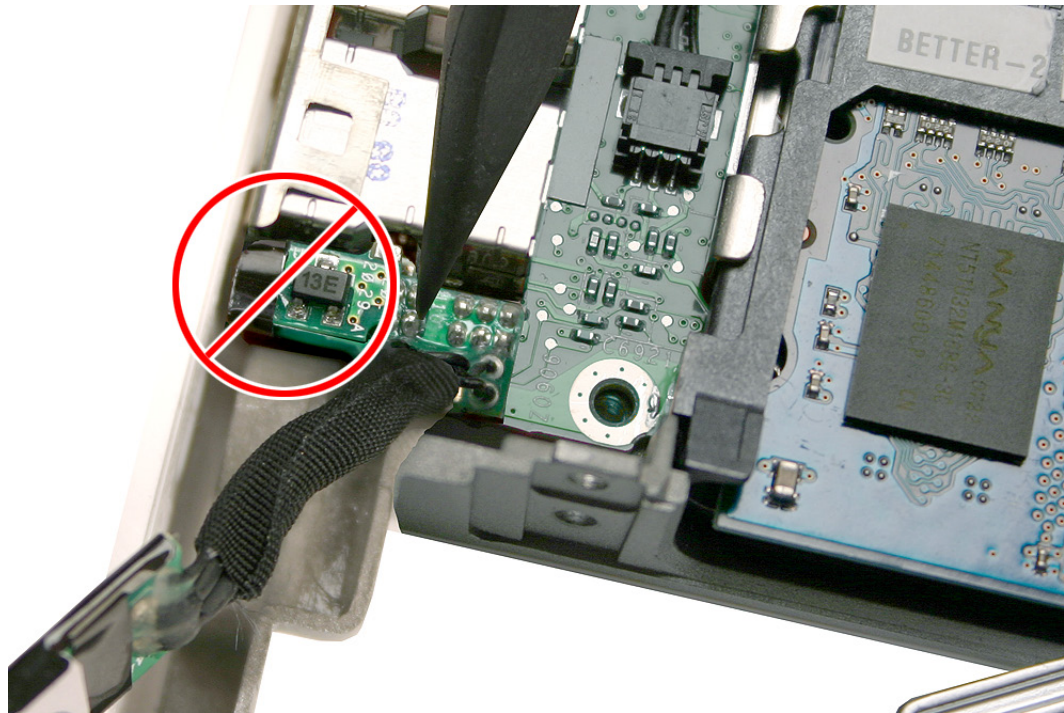

- 
7. Install the replacement battery connector with sleep switch, and reassemble and test the computer.

**Caution:** To avoid pinching the cable, the battery connector cable must be properly tucked into the cable channel, as shown by the image on the left, below:

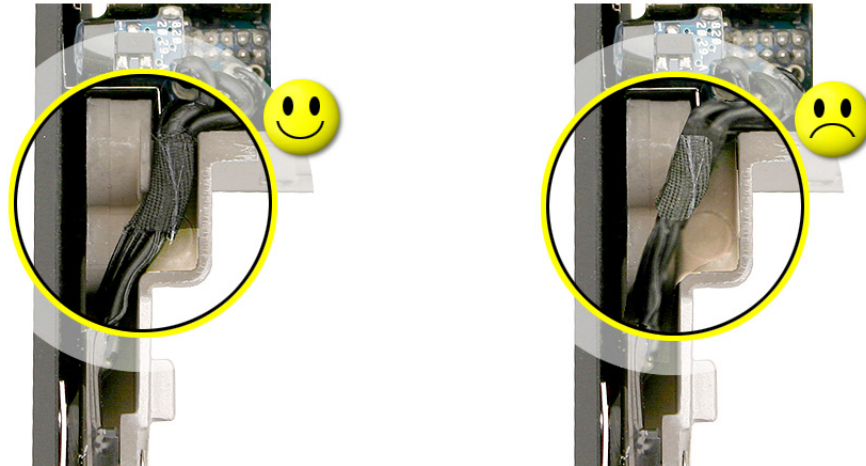

**Replacement Note:** With the part fully installed, check that the battery connector can be wiggled to allow for movement of the battery. If the connector is completely still when grasped, loosen the screws slightly.



# Hard Drive Connector

## Tools

- ESD wrist strap and mat
- Magnetic Phillips #0 screwdriver
- Black stick (Apple part no. 922-5065) or other nonconductive nylon or plastic flatblade tool)

## Preliminary Steps

Before you begin, remove

- [Battery](#)
- [RAM door](#)
- [Top case with keyboard](#)
- [Hard drive](#)

## Part Location

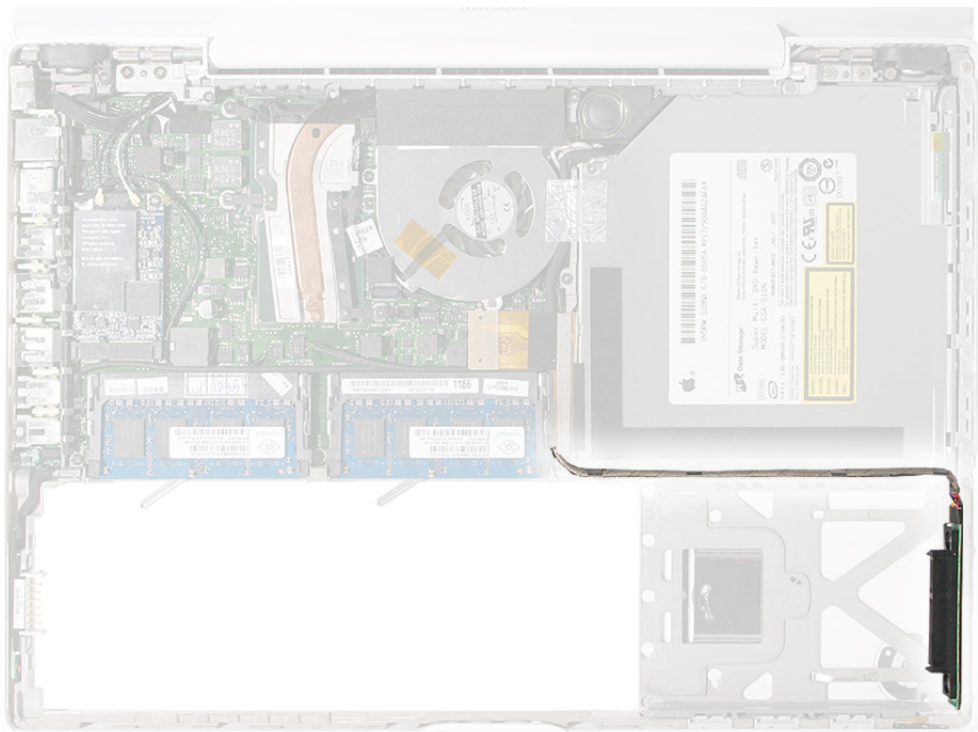

## Procedure

1. Disconnect the optical drive flex cable from the logic board.

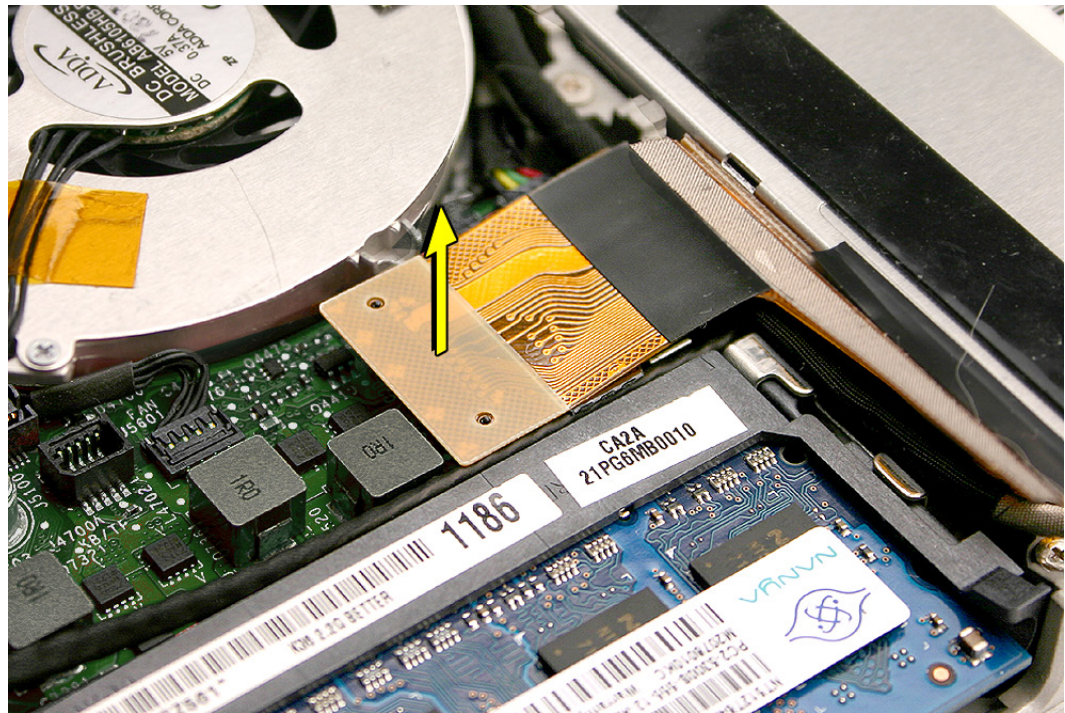

2. Use the pull tab to disconnect the LVDS connector cable.



3. Use the pull tab to disconnect the hard drive cable connector.

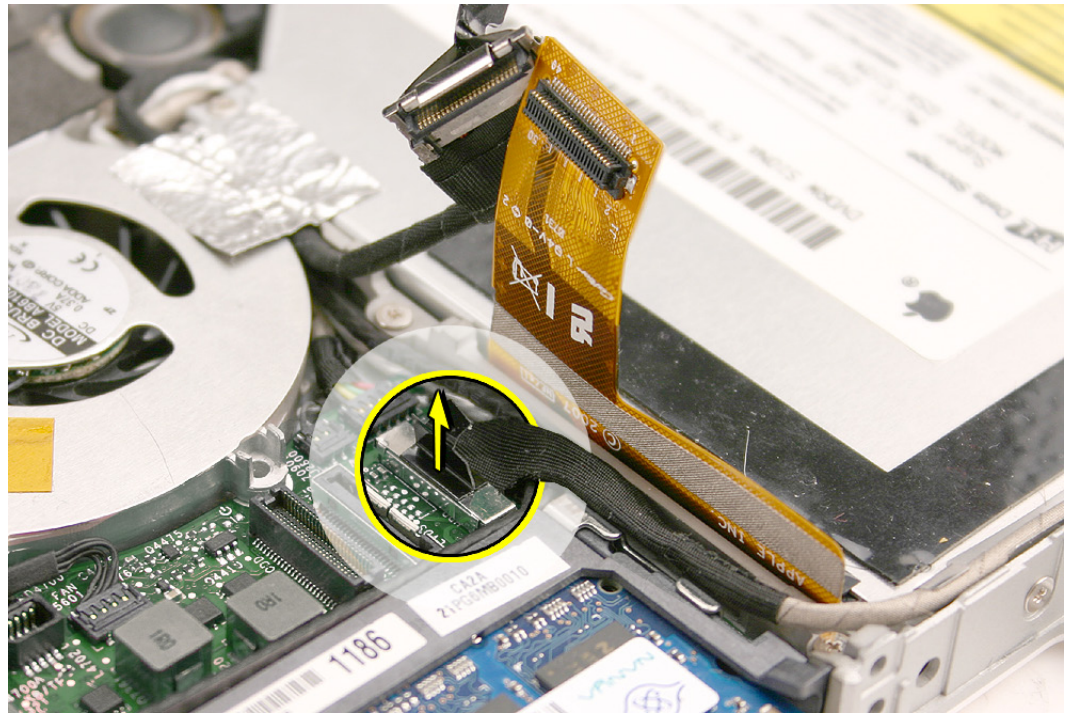

4. Pull up the hard drive connector cable that runs along the bottom edge of the optical drive. Note the four cable routing guides when reinstalling the cable.

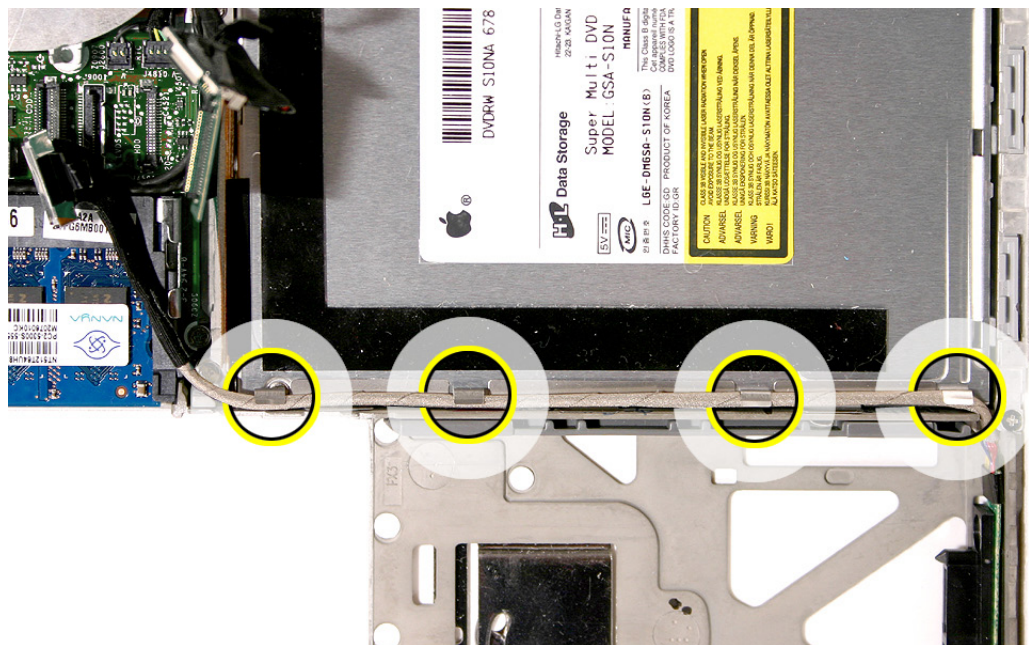

5. Remove the two 6-mm long screws from the hard drive connector at the right front side of the computer.

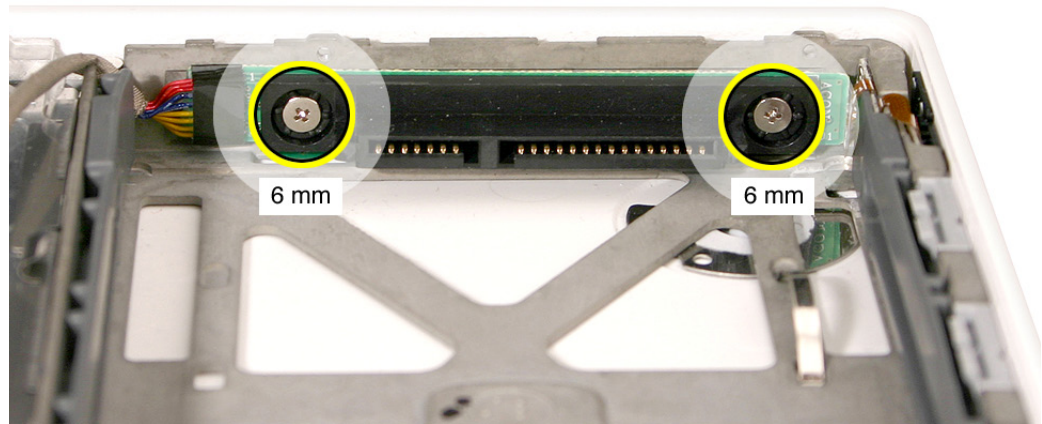

6. Carefully lift up the hard drive connector from the bottom case. This action automatically disconnects the hard drive board from the sleep LED/IR receiver flex cable.

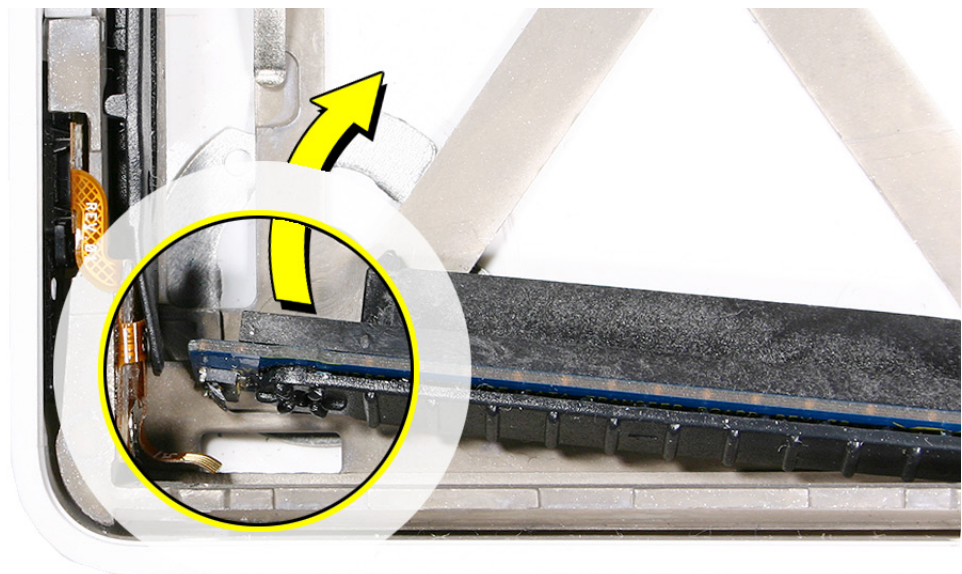

**Replacement Caution:** Note the tiny connector at the end of the hard drive board. It connects to the sleep LED/IR receiver board at the front right corner of the computer via a tiny flex cable. To reinstall the flex cable, first peel up the end of the snubber to access the length of the flex cable. Carefully peel up the flex cable from its adhesive. Using a black stick, tilt up the tiny flex cable at the right corner. Insert it into the connector on the hard drive board, and fold down the tiny locking lever on the connector. Without straining the connection, carefully tilt the hard drive board into place in front of the snubber.

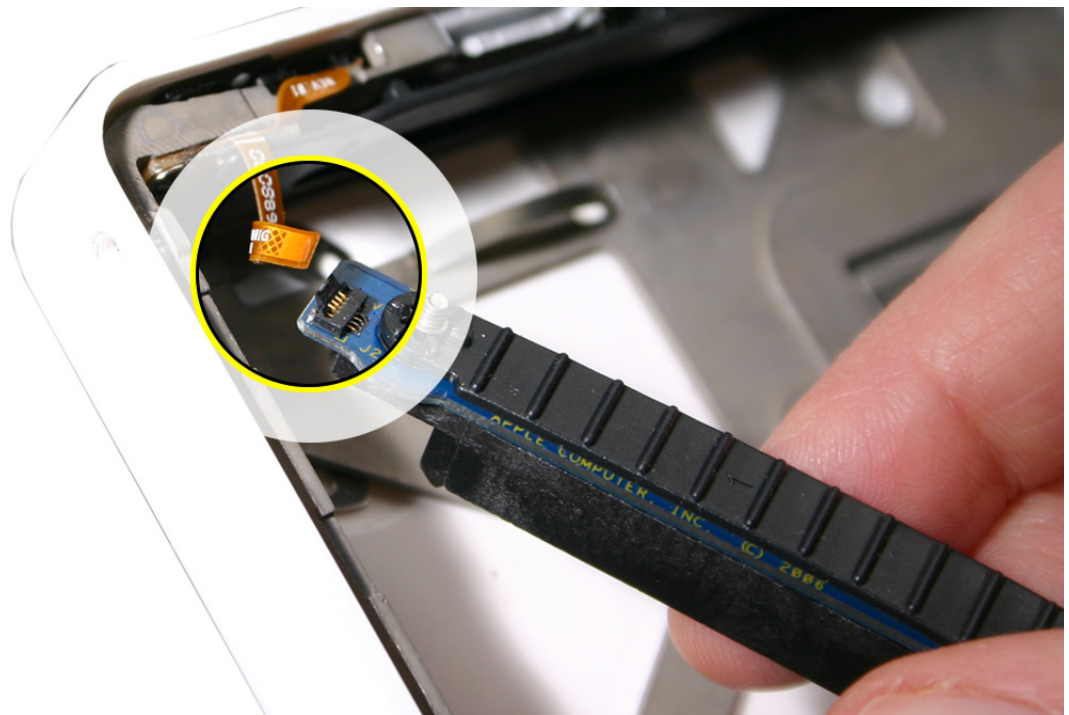
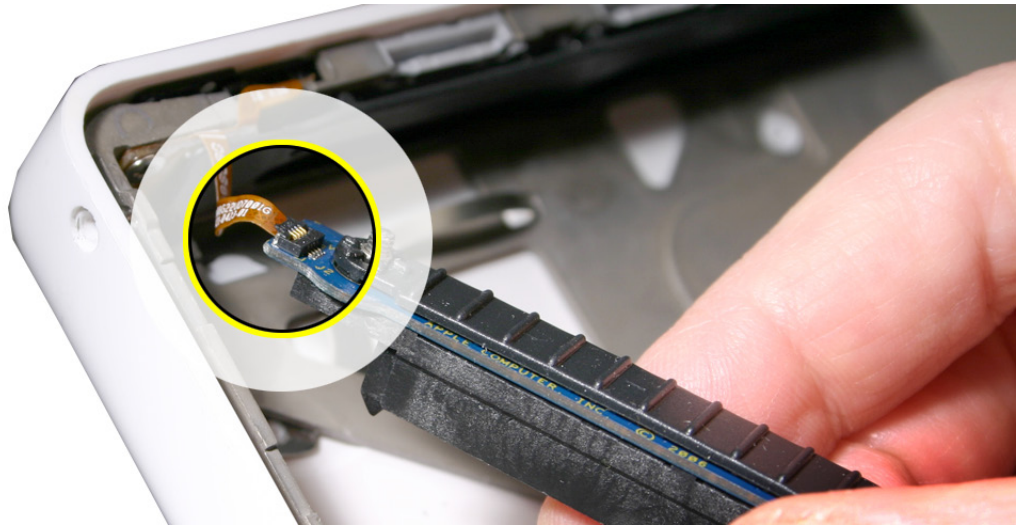

- 
7. Install the replacement hard drive connector, and reassemble and test the computer.

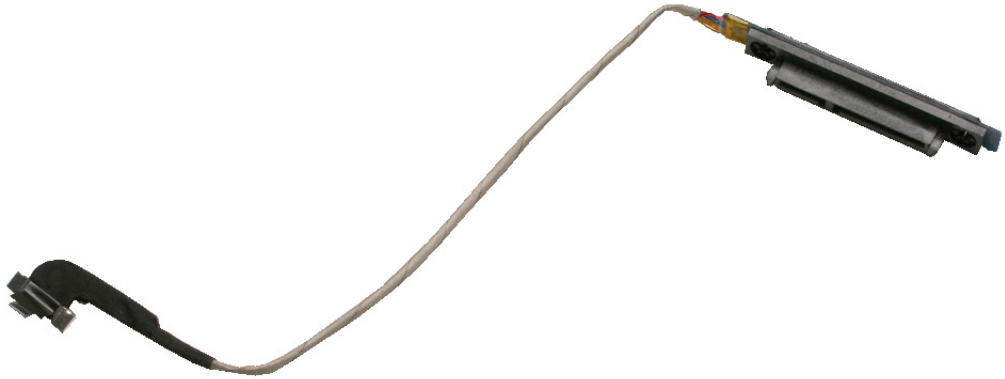



## Fan

### Tools

- ESD wrist strap and mat
- Magnetic Phillips #00 screwdriver
- Black stick (Apple part no. 922-5065) or other nonconductive nylon or plastic flatblade tool

### Preliminary Steps

Before you begin, remove

- [Battery](#)
- [RAM door](#)
- [Top case with keyboard](#)

### Part Location

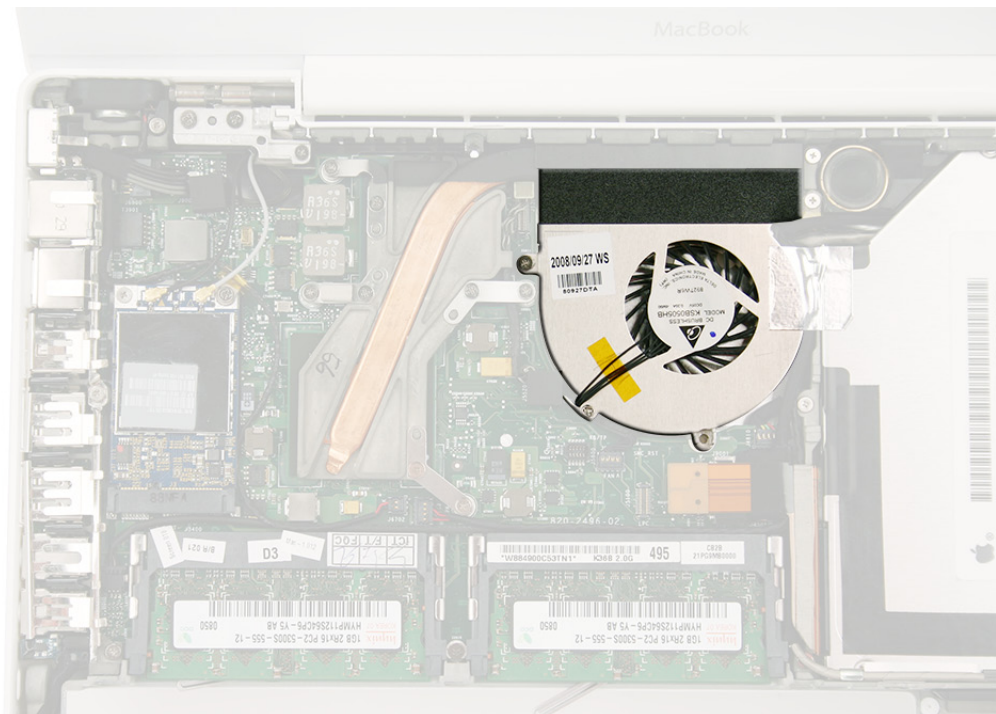

## Procedure

1. Peel up the strip of tape that overlaps the fan near the optical drive.
2. Remove the screws from the fan:
  - 6.5-mm long screw from the upper left
  - 3.5-mm long screw from the upper right (normally hidden underneath the cable bundles)

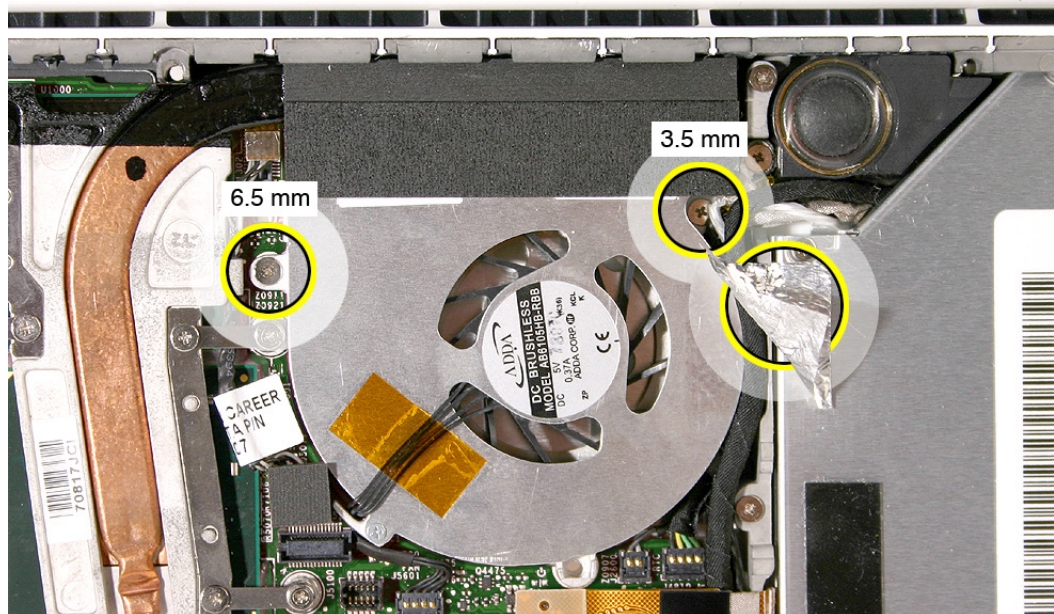

3. Disconnect the fan cable from the logic board.

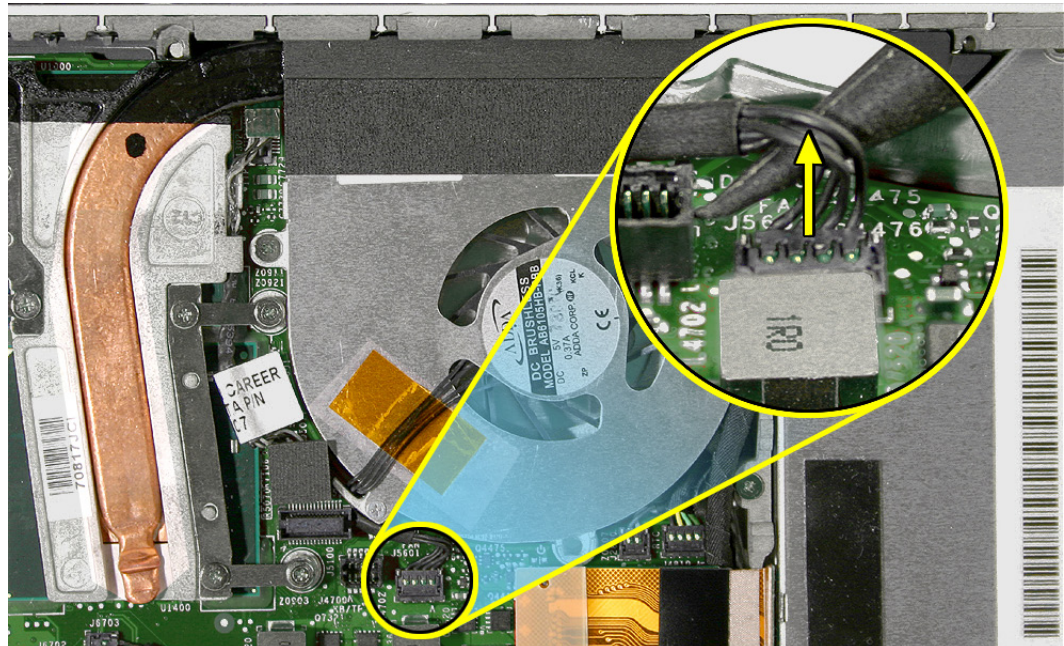

4. Tilt up the fan and remove it from the logic board.

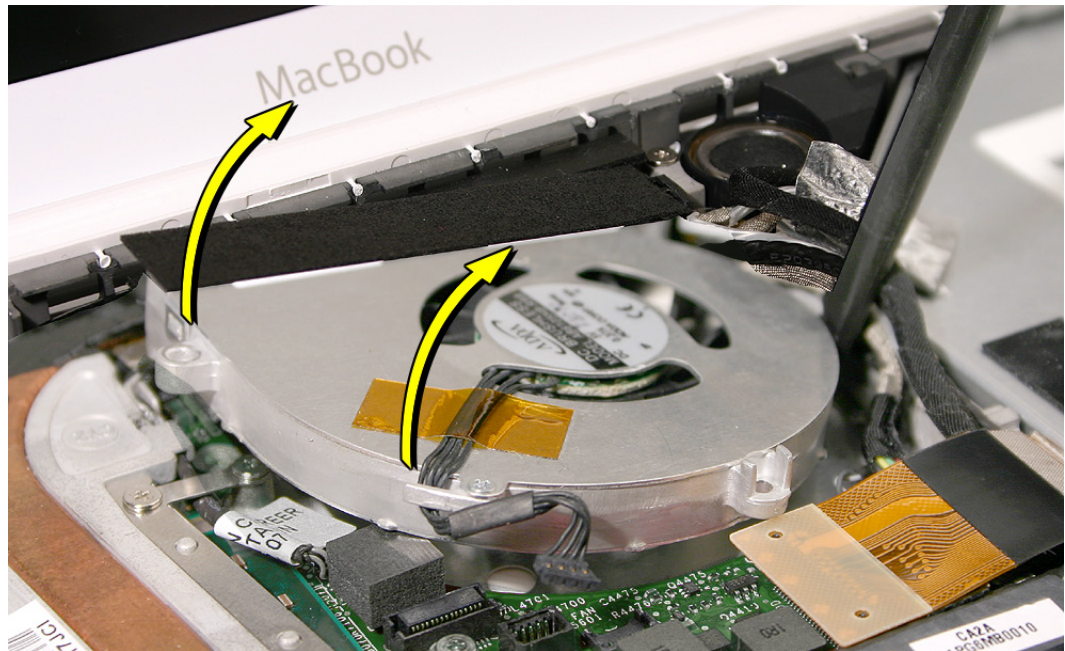

5. Peel away the adhesive foam that overlaps the fan and the heatsink.

**Replacement Note:** Be sure to install the strip of adhesive foam before reassembling the computer.



6. Install the replacement fan, and reassemble and test the computer.

**Replacement Note:** Make sure the cables are fully tucked in the channel between the fan and the optical drive. Reapply the tape or apply new tape.



# Heatsink

## Tools

- ESD wrist strap and mat
- Magnetic Phillips #0 screwdriver
- Black stick (Apple part no. 922-5065) or other nonconductive nylon or plastic flatblade tool
- Alcohol wipes
- Thermal grease syringe (Apple part number 922-7144)
- Felt-tip pen (optional)

## Preliminary Steps

Before you begin, remove

- [Battery](#)
- [RAM door](#)
- [Top case with keyboard](#)
- [Fan](#)

## Part Location

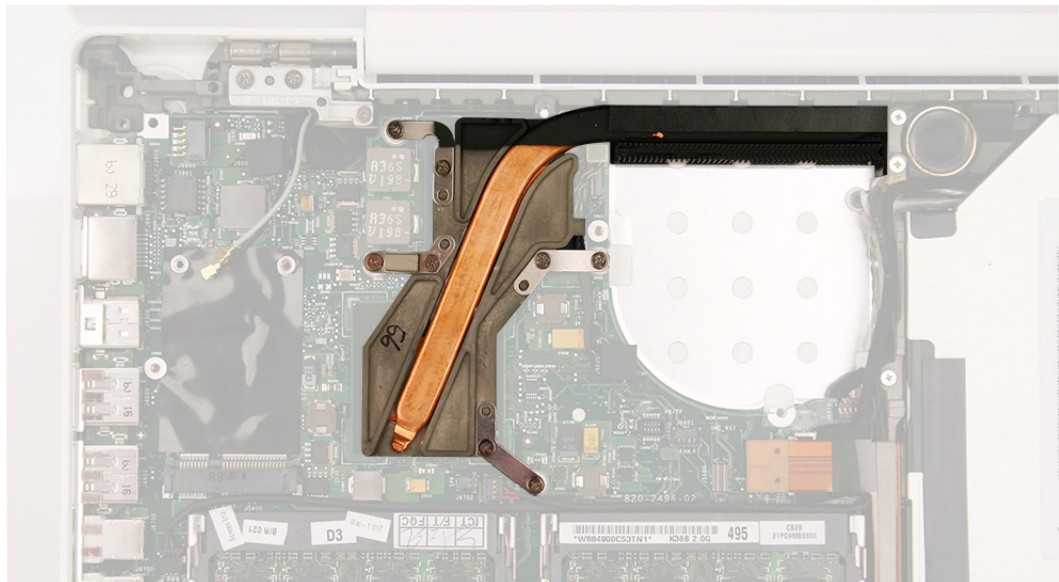

## Procedure

**Note:** Though photos in this section may vary from the actual model you are repairing, the procedure remains exactly the same.

**Important Note:** Replacement heatsink modules have the thermal grease pre-applied. However, if you are reusing the unit's existing heatsink, you must apply new thermal grease. See the section "Checking the Thermal Grease" at the end of this chapter.

1. Remove the four identical 8-mm long screws from the heatsink.

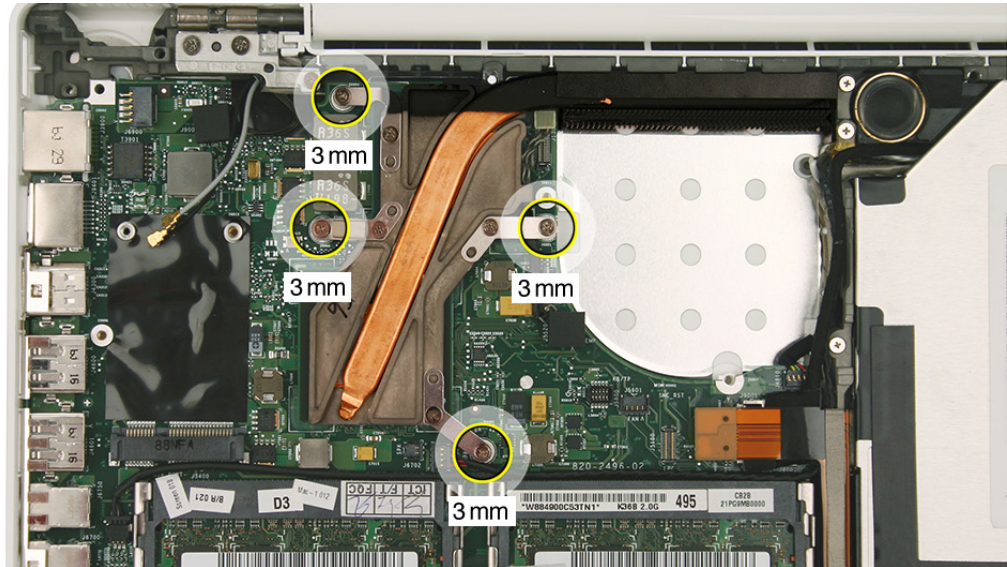

**Replacement Note:** When replacing the screws, install them in the order shown below:

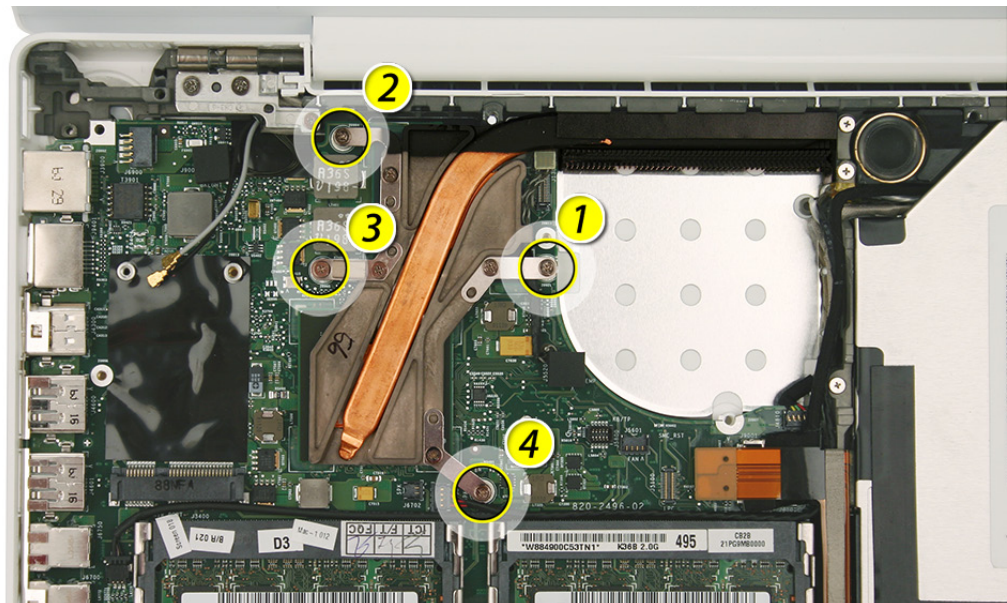

2. **(For MacBook (13-inch, Early 2009)):** The heatsink on the unit you are repairing may or may not have a thermal sensor cable (see photo). If not, skip to step 3.
  - If the thermal sensor is present, first remove the black square foam pad on the logic board connector, and set it aside for re-use.

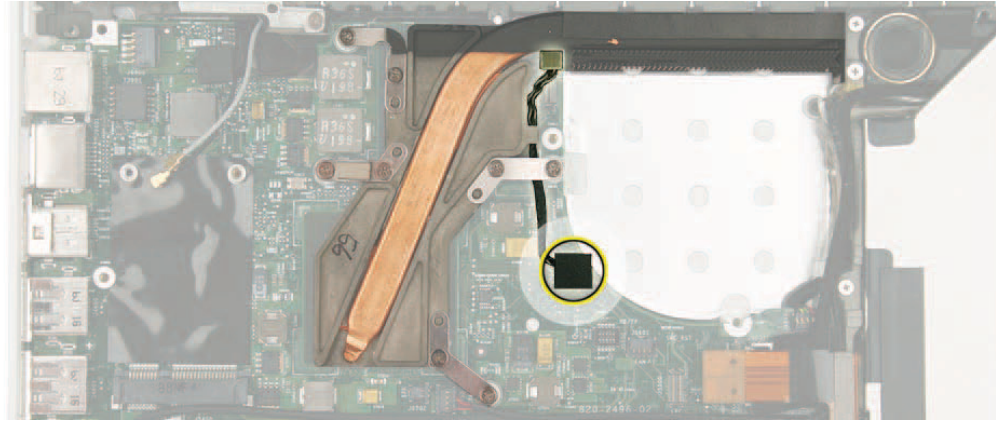

- Use a black stick to disconnect the JST connector straight up from the logic board.

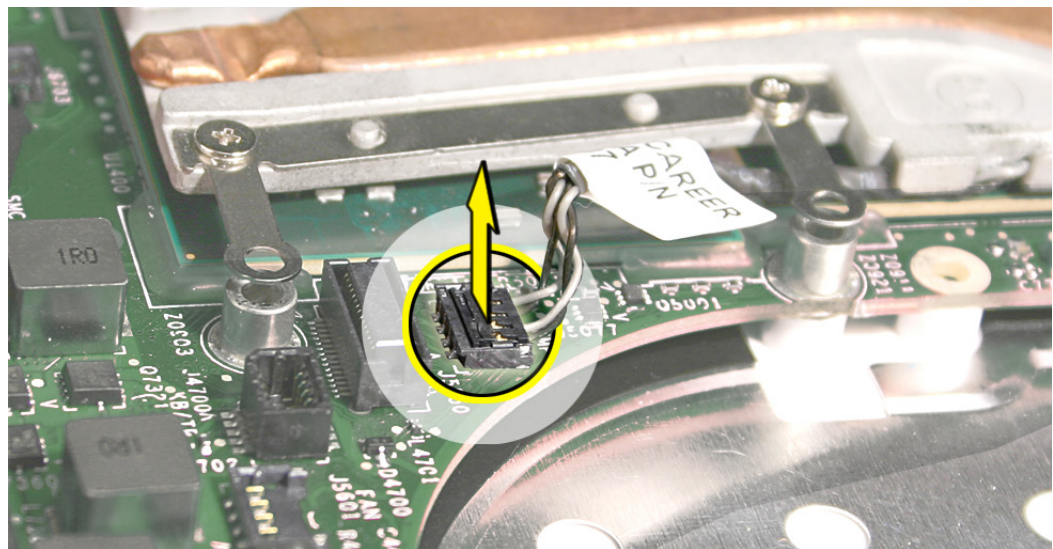

3. To remove the existing heatsink, hold the lower end to tilt and loosen it from the logic board.

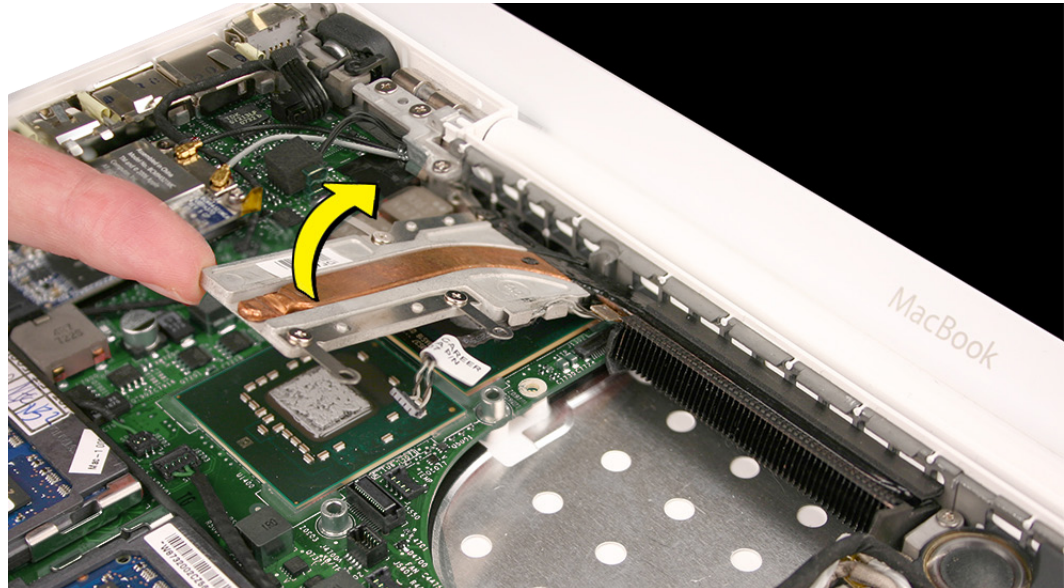

4. **Important:** Anytime the heatsink is removed (even if it is to replace another module), check the thermal grease as described in the next section.

**MacBook (13-inch, Early 2009) Replacement Note:** The replacement heatsink may have a thermal sensor cable attached (even if the defective heatsink did not). If the heatsink has a cable, connect the cable to the logic board if the logic board has a socket, if not, secure the connector to the logic board with Kapton tape (without connecting).

---

## Checking the Thermal Grease

**Warning:** Whenever the heatsink is separated from the logic board (even if you are installing the same heatsink or board), the thermal grease must be checked and possibly replaced. Failure to do so can cause the computer to overheat and be damaged.

1. **Caution:** This step is required when the heatsink and logic board are removed to replace a later part (such as the bottom case) and the same heatsink and logic board will be re-installed in the computer.

Use a black stick to remove as much thermal grease as possible from the two chips on the logic board and the two pads on the heatsink.

Use an alcohol wipe to completely clean the residual thermal grease from the two chips on the logic board and the two pads on the heatsink.

**Important:** Use extreme care not to damage the logic board components.

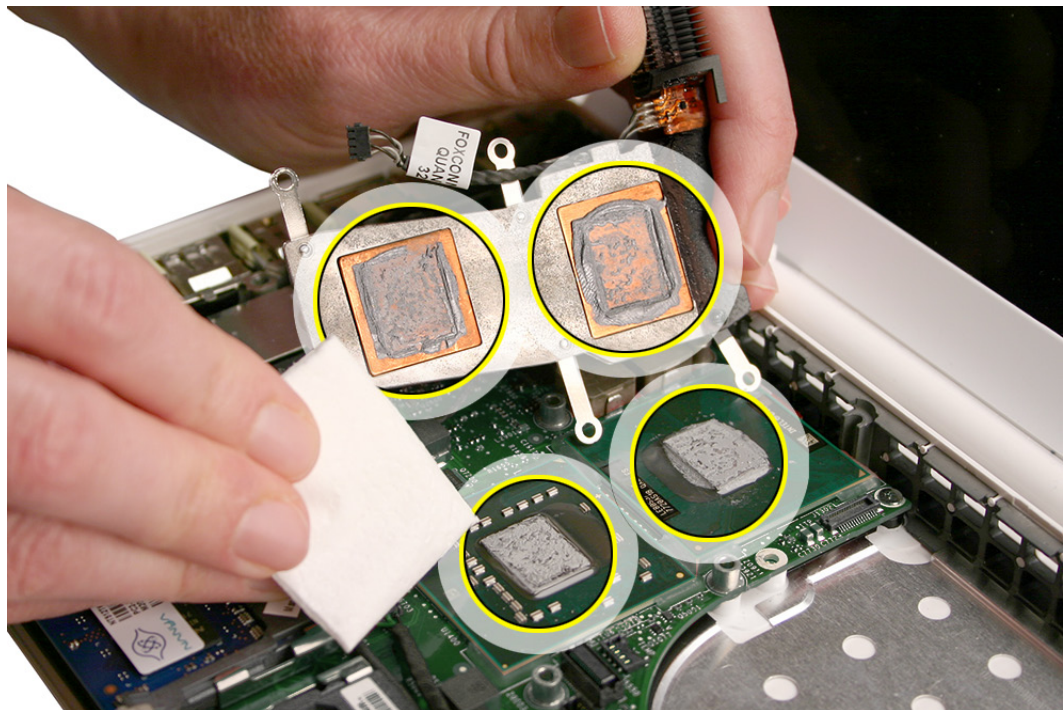

2. **Caution:** The syringe steps for this procedure are required only when the heatsink and logic board are removed to replace a later part (such as the bottom case) and when no new heatsink with pre-applied thermal grease will be installed. Refer to the heatsink conditions in step 1 for details before attempting to replace the thermal grease.

Note the contents of the syringe of thermal grease.

**Important:** One syringe (922-7144) contains 0.3 to 0.35 cubic centimeters (cc) of thermal grease. That is enough for 0.1 to 0.12 cc of grease per chip for up to three chips. Because this computer has only two chips, the last 1/3 of thermal grease remains in the syringe. Use one-third of the syringe contents per chip. Using a felt-tip pen, mark the 1/3 points on the syringe before applying the first dab.



3. Using the syringe, put a 0.1 to 0.12 cc dab of thermal grease, in the center, on the mating surfaces of both chips, as shown below. Apply the grease only up to the line that you marked on the syringe.

**Important:** Use one-third of the syringe contents per chip, so in this case, 1/3 of the thermal grease will be left in the syringe when you are done. Although the amount shown appears to be plenty of grease, this is the correct amount that has been tested and verified on the production line.

**Important:** Avoid unnecessary contact with new thermal material, as dirt and body oils reduce the material's conductivity.

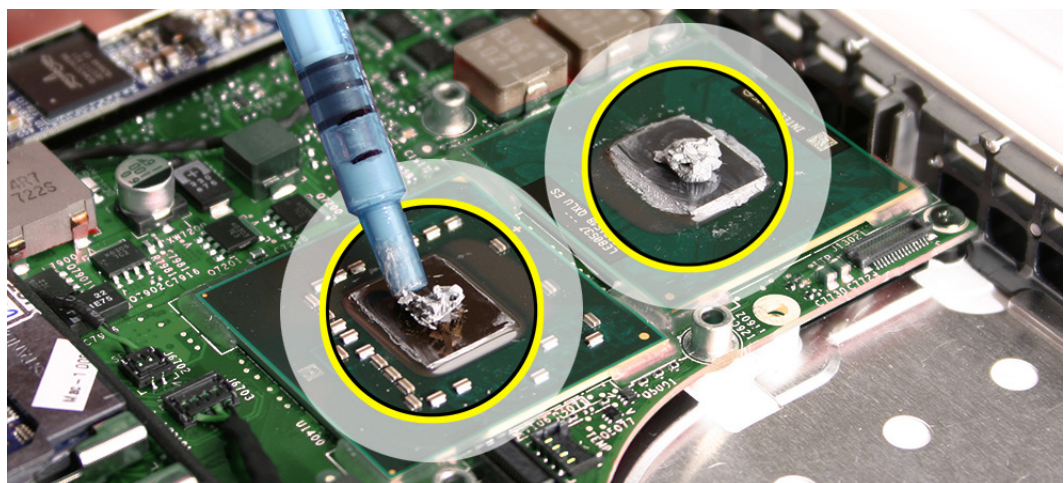

4. While centering the heatsink pads over the two chips, lower the heatsink onto the logic board and press on the areas where the screw brackets on the heatsink meet the standoffs on the board. Make sure the heatsink is level on the board before installing the screws.

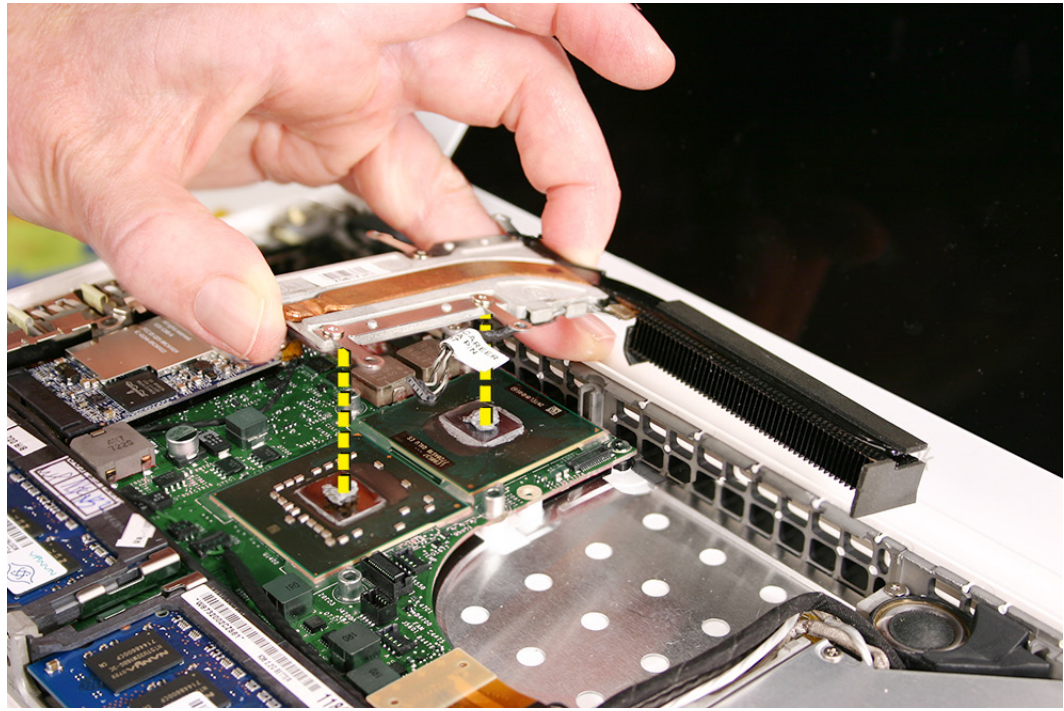

5. Install the heatsink screws in the order shown, and reassemble and test the computer.

**Note:** Make sure the heatsink includes the gray, adhesive sponge strip that sticks to and runs along the top right section of the copper pipe. (A new heatsink kit includes the gray strip, ready for installation.)

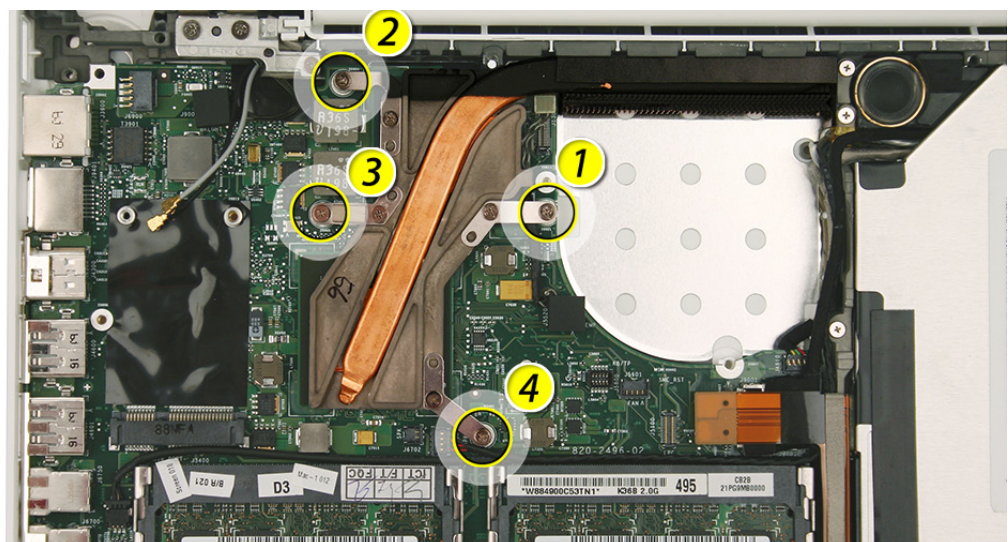



# Bluetooth Holder

**Important:** The Bluetooth holder is included with a replacement optical drive and should not be removed unless it is damaged or no longer sticks to the optical drive housing.

## Tools

- ESD wrist strap and mat
- Any standard size CD or DVD disc
- Black stick (Apple part no. 922-5065) or other nonconductive nylon or plastic flatblade tool

## Preliminary Steps

Before you begin, remove

- [Battery](#)
- [RAM door](#)
- [Top case with keyboard](#)

## Part Location



---

## Procedure

1. Insert a CD or DVD disc half way into the slot drive to help support the drive and prevent damage.



2. Use a black stick to slide out the Bluetooth board from its holder.



3. **Warning:** To prevent damage to the optical drive, do not touch or press anywhere else on the drive.
4. Use a black stick to carefully pry up the Bluetooth holder from the top of the optical drive. Make sure you use as little pressure as possible to prevent damage to the drive.



**Replacement Note:** Peel off the adhesive backing from the Bluetooth holder and apply it to the drive where shown. Press the holder lightly to make sure it adheres to the drive.



- 
5. Install the replacement Bluetooth holder, remove the optical drive disc, and reassemble and test the computer.





# Optical Drive

## Tools

- ESD wrist strap and mat
- Magnetic Phillips #0 screwdriver
- Black stick (Apple part no. 922-5065) or other nonconductive nylon or plastic flatblade tool

## Preliminary Steps

Before you begin, remove

- [Battery](#)
- [RAM door](#)
- [Top case with keyboard](#)

## Part Location

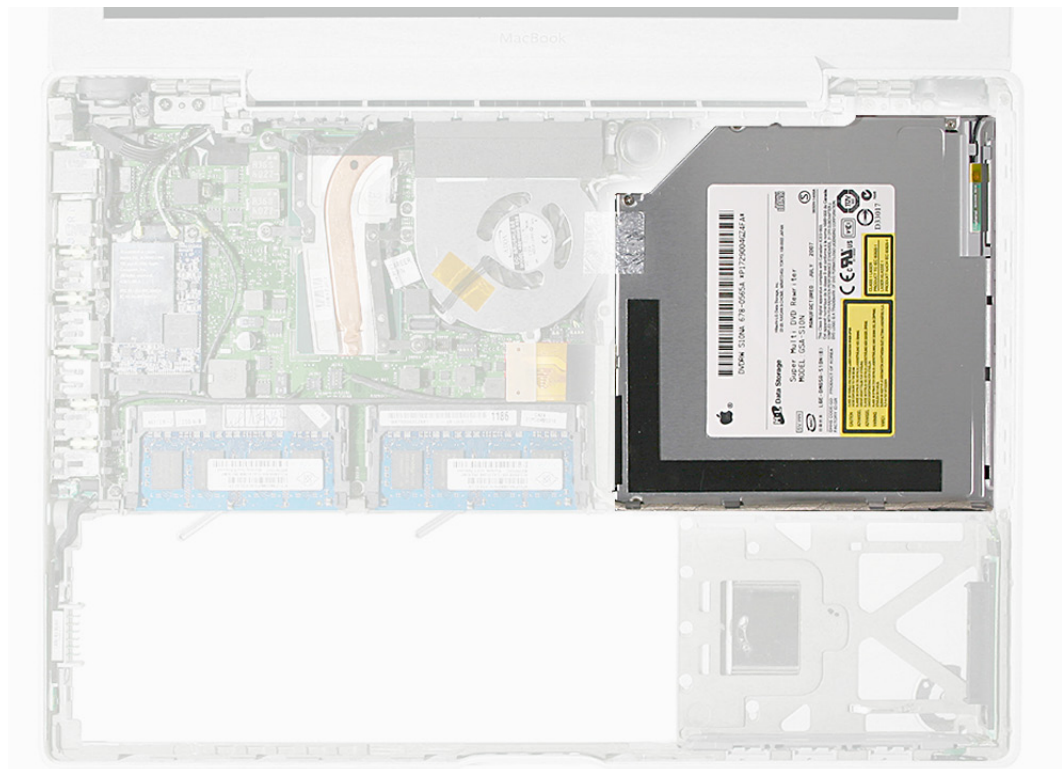

## Procedure

1. With the computer assembly on a clean, scratch-proof surface, locate the Bluetooth board and holder at the upper right corner of the drive. Note that the Bluetooth holder stays with the drive and is included with a replacement optical drive.
2. Tilt up the Bluetooth board from the Bluetooth holder.

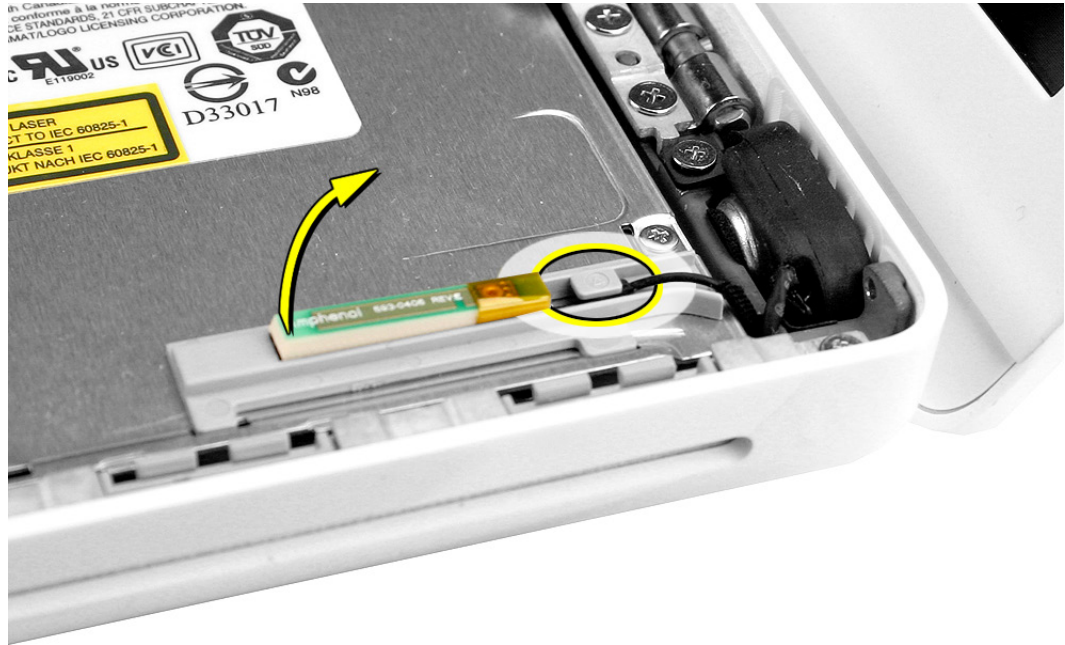

3. Disconnect the optical drive flex cable from the logic board.

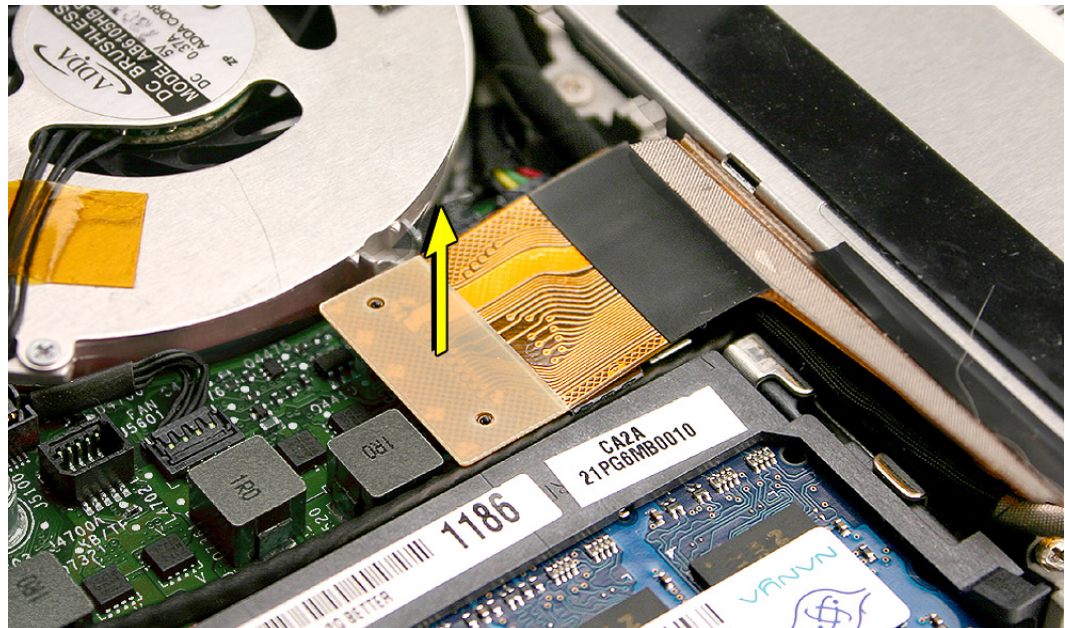

4. Peel up the tape from the optical drive.
5. Use a black stick to move aside the cables to reach the 3-mm long screw securing the mounting bracket for the drive. You might first need to disconnect the ground screw by the speaker to loosen the cables enough to remove the mounting bracket screw.

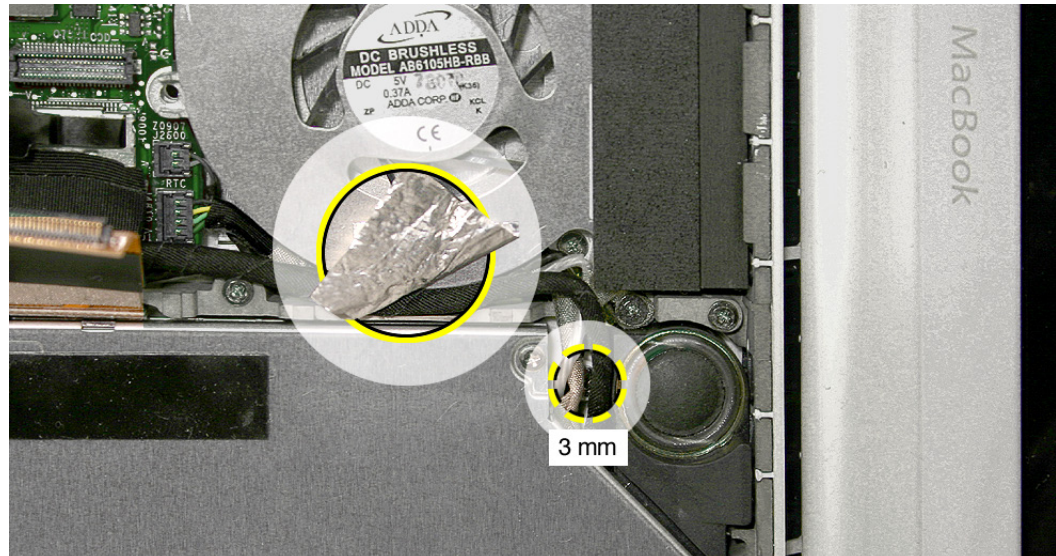

6. Use a black stick to slide the mounting bracket forward (away from the body of the drive and toward the fan) to disengage it.

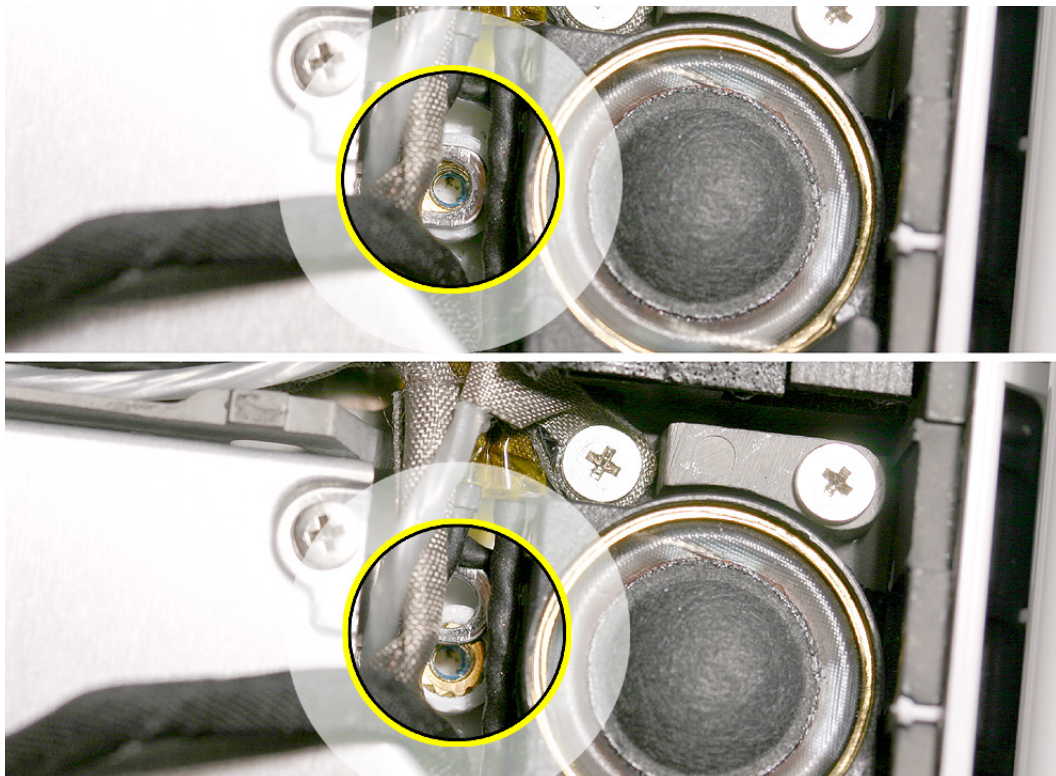

- Slide out the hard drive, and set it aside.

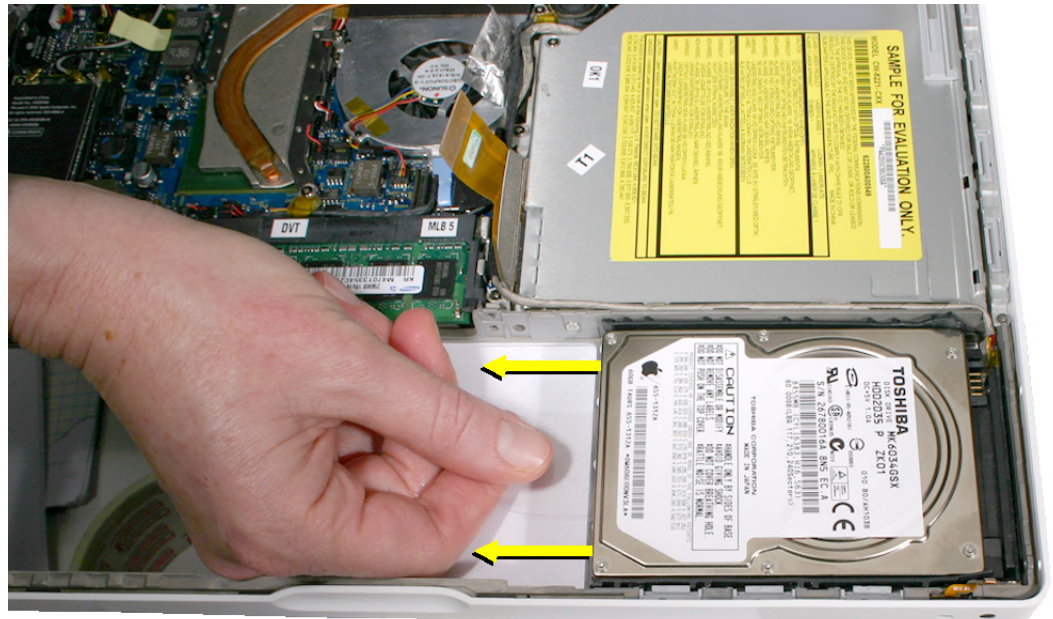

- Remove the two screws along the bottom edge of the drive at the hard drive snubber. (If the snubber is blocking one of the screws, carefully peel up the snubber.)

**Replacement Note:** Make sure you install the longer screw (4.5 mm) closest to the right side of the bottom case.



9. Lift up the cable that runs between the drive and the snubber at the lower edge of the optical drive.

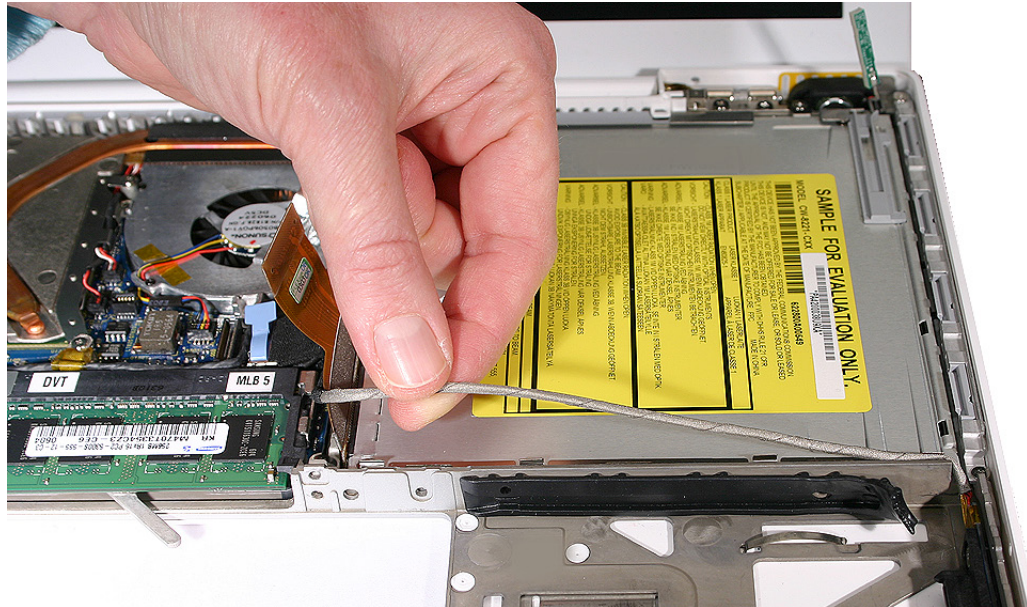

10. **Warning: Handle the optical drive at the side edges only. Do not touch or press anywhere else on the drive. Refer to the next section, "Handling Slot-Load Optical Drives."**
11. Grasp the optical drive flex cable, and use it as a pull tab as you tilt up the optical drive just enough to clear the bottom case frame. Be careful where it can catch on cables, and slide it away from the rear frame.

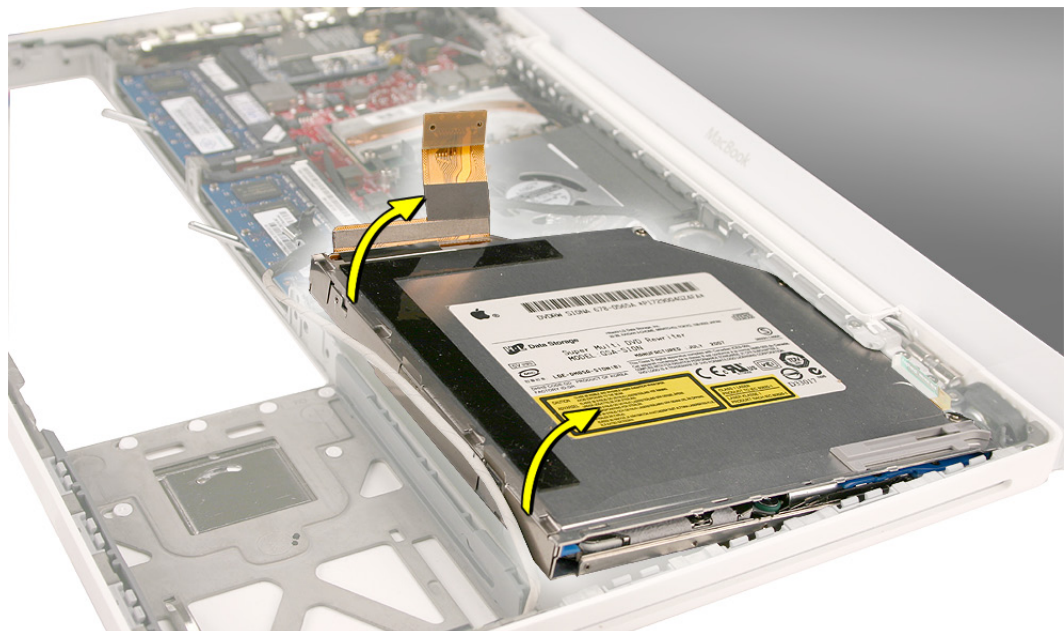

**Replacement Note:** Make sure the mounting bracket on the optical drive is pushed in before placing the optical drive in the bottom case.



**Replacement Note:** Reverse the screw order: install snubber screws first.

**Replacement Note:** If you are installing a replacement drive, check that it includes the following:

- Bluetooth holder
- Sliding bracket and two screws
- Cable guide rail

**Replacement Note:** If you are installing a replacement drive, check that the sliding bracket that is secured with two screws slides easily and is not too tight. If it is too tight, loosen the screws just enough so the bracket slides with ease.

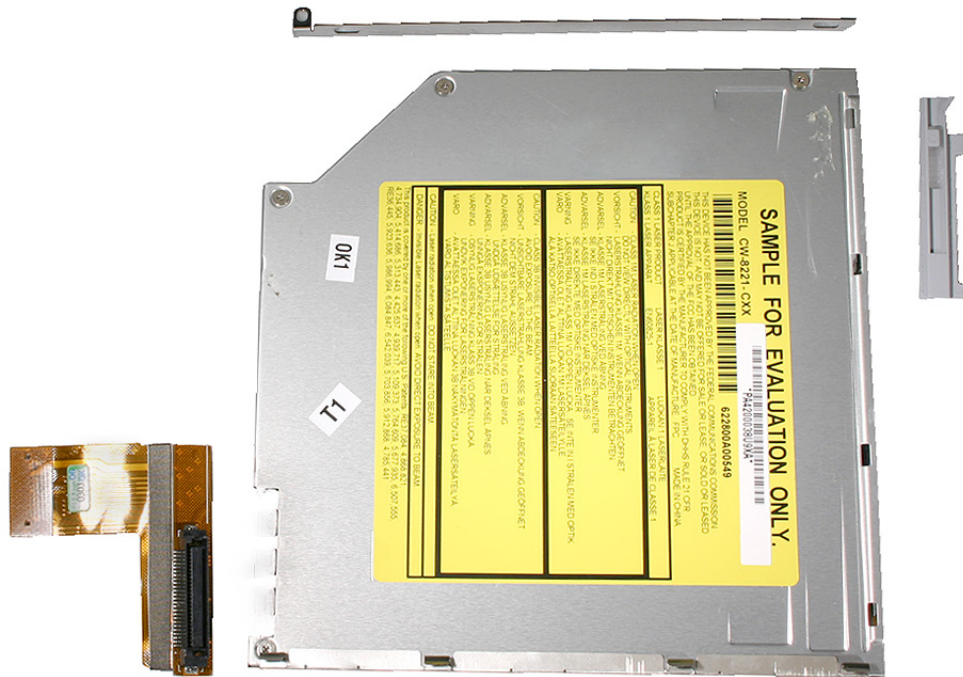

12. Before installing the optical drive, make sure the cables on the bottom case are routed as shown.

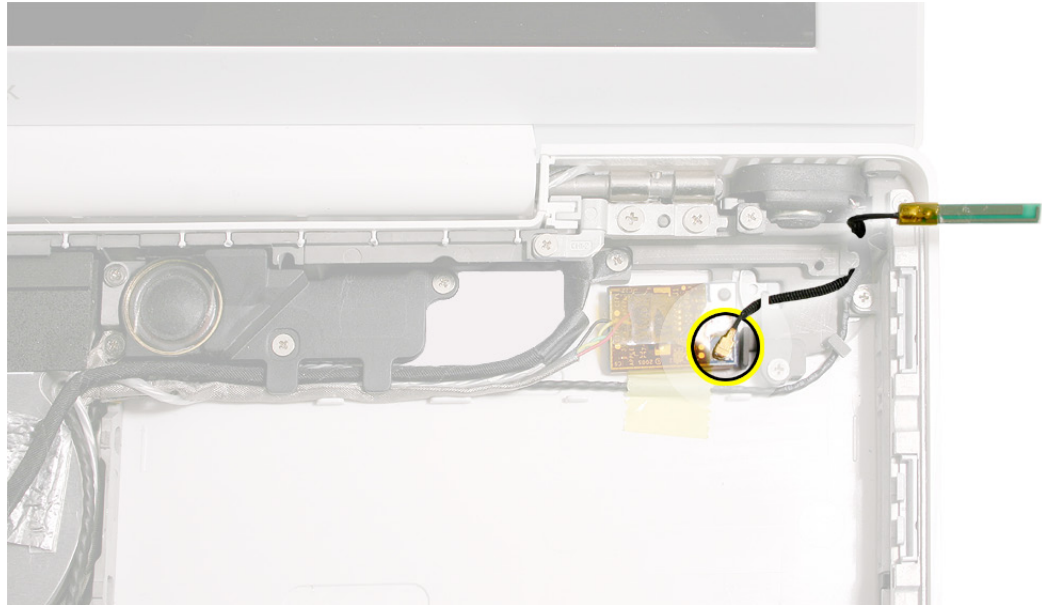

13. Install the replacement optical drive and reassemble and test the computer. (Note: The L-shaped strip of black tape is for controlling vibration; do not remove the tape.)



**Important:** For best performance after a new optical drive replacement, be sure to update the operating system to the latest Mac OS X version.

---

## Handling Slot-Load Optical Drives

Follow the instructions in this section carefully. This procedure shows how to handle slot-load optical drives when they are outside the computer.

- Observe ESD (electrostatic discharge) guidelines when handling optical drives.



- Handle the drive only by the sides and back edge.

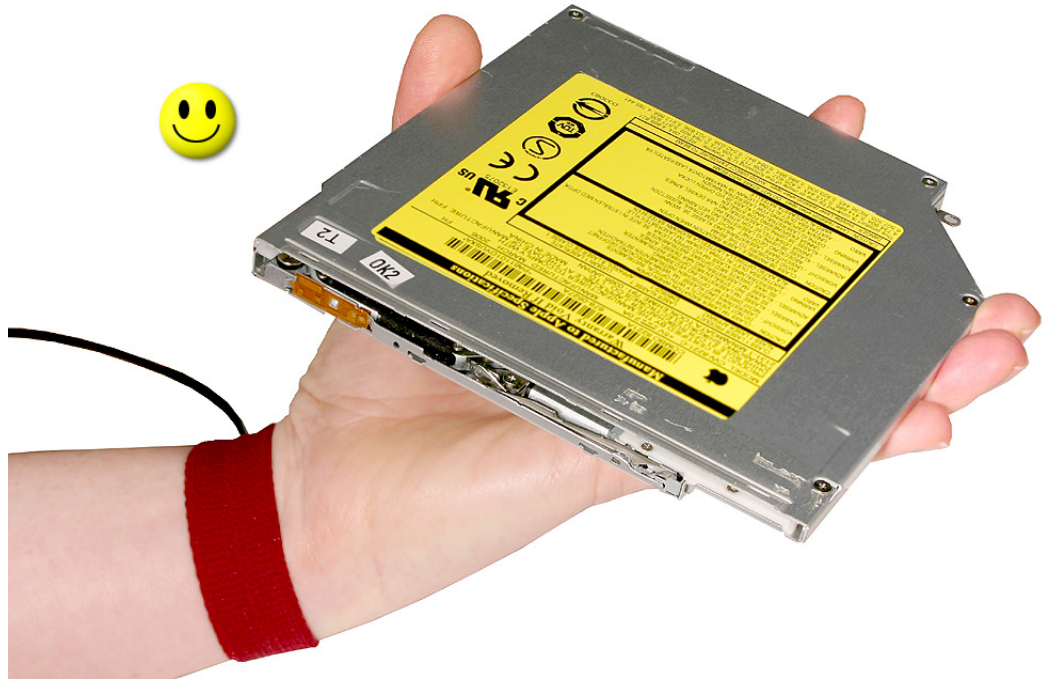

- Do not touch the front of the drive.



- Do not press on the drive or lift it by the top and bottom cover.



- Do not handle the drive by the gull wing edge only.



- 
- When storing optical drives, use approved packaging boxes. Never stack loose drives.



- When returning a defective optical drive, use the original packaging and an antistatic bag. Pack only one drive per box.



---

## Removing a Stuck Disc from an Optical Drive

**Important:** This procedure applies only to 9.5-mm and 12.7-mm slot-load optical drives.

1. Remove the four identical screws that hold the top cover to the drive.



2. Slide the top cover approximately 2 mm toward the back of the drive. Lift up the top cover to remove it.



- 
3. Check the placement of the disc. It is either clamped to the turntable at the center of the disc, or it is wedged under one or more posts at the outer edge of the disc.
  4. Holding the edge of the disc, press on the center clamp or hold the posts steady as you remove the disc from the drive.  
Important: Do not touch any key components located near the disc.



5. Replace the top cover on the drive so that the small hooks on the top cover fit into the slots on the bottom cover. Then slide the top cover into place.



6. Replace the four screws.
7. Install the replacement drive, and reassemble and test the computer.



# Optical Drive Cable

## Tools

- ESD wrist strap and mat
- Black stick (Apple part no. 922-5065) or other nonconductive nylon or plastic flatblade tool

## Preliminary Steps

Before you begin, remove

- [Battery](#)
- [RAM door](#)
- [Top case with keyboard](#)
- [Optical drive](#)

## Part Location



---

## Procedure

**Warning:** Handle the optical drive at the side edges only. Do not touch or press anywhere else on the drive.

1. With the optical drive on a clean, scratch-proof surface, use a black stick to evenly pry up the cable connector from the drive.

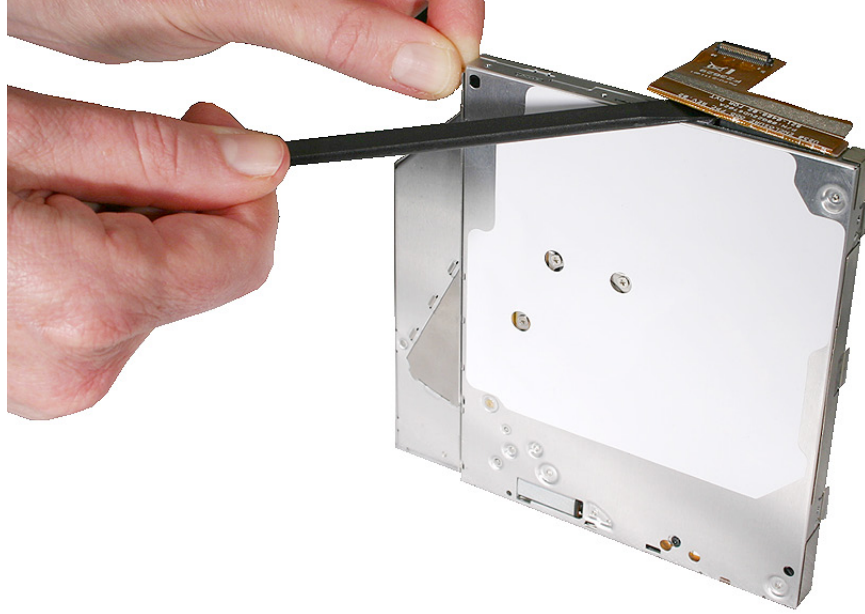

2. Carefully pry up the thin strip of black tape that overlaps the optical drive cable. Then pry up the connector from the drive.



3. Remove the optical drive cable.

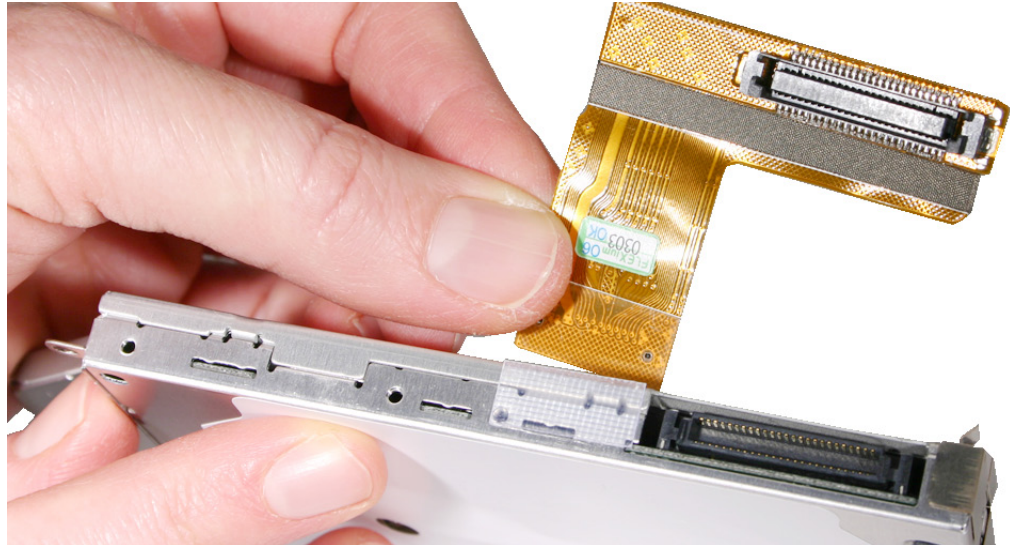

4. Install the replacement optical drive cable, and reassemble and test the computer.

**Note:** both sides of the cable may have an adhesive mesh strip.

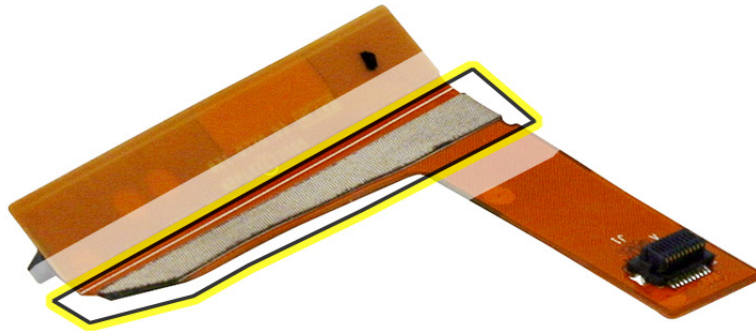

**Note:** the cable might also include a mylar strip. If attached, do not remove it.





# Bluetooth Antenna Board and Cable

## Tools

- ESD wrist strap and mat
- Magnetic Phillips #0 screwdriver
- Black stick (Apple part number 922-5065) or other nonconductive nylon or plastic flatblade tool

## Preliminary Steps

Before you begin, remove

- [Battery](#)
- [RAM door](#)
- [Top case with keyboard](#)
- [Optical drive](#)

## Part Location

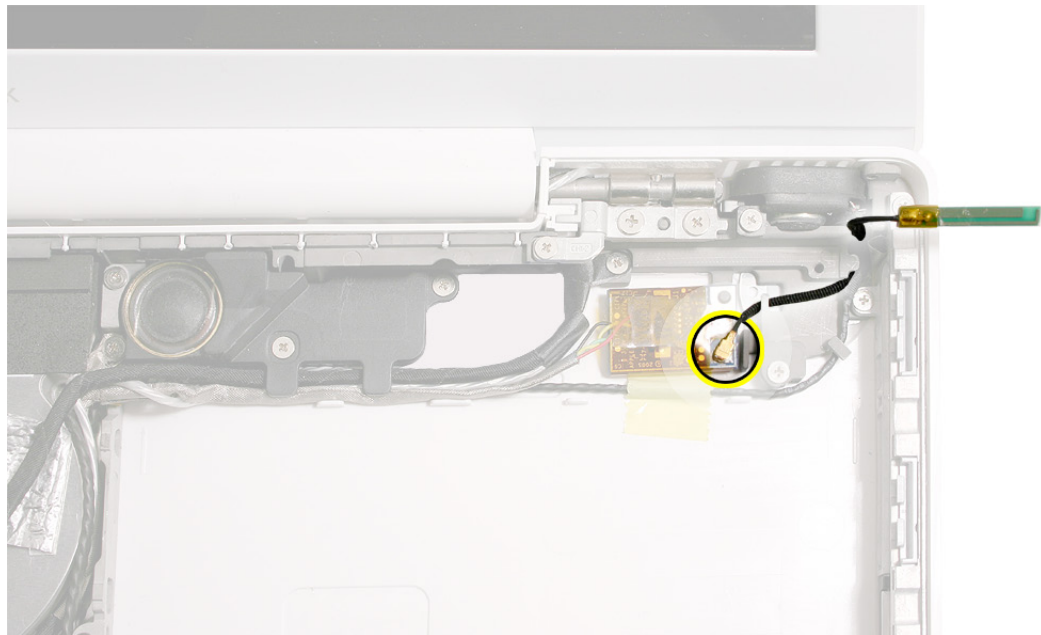

---

## Procedure

1. Remove the 3-mm screw from the right speaker.

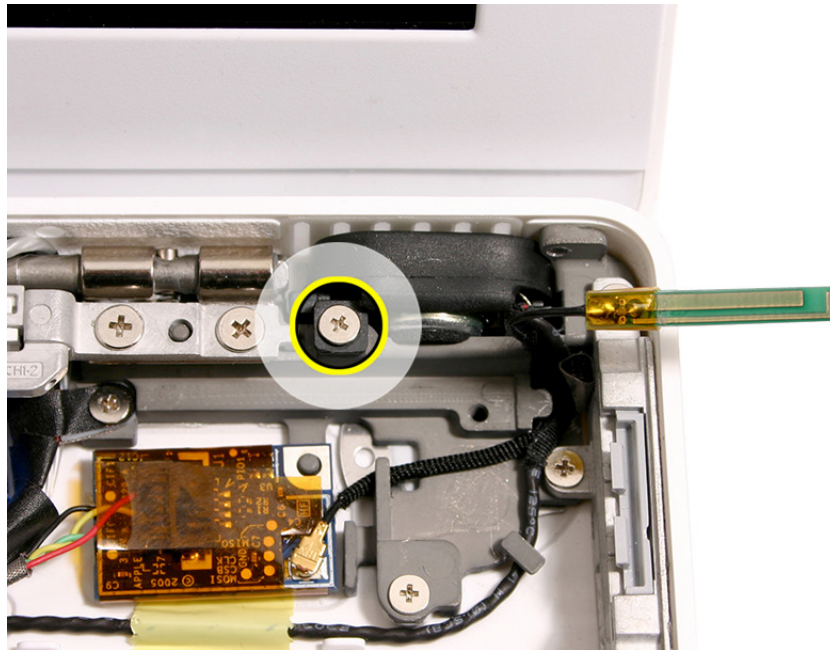

2. Without straining the speaker cable, tilt up the speaker and unroute it from the right corner of the frame.

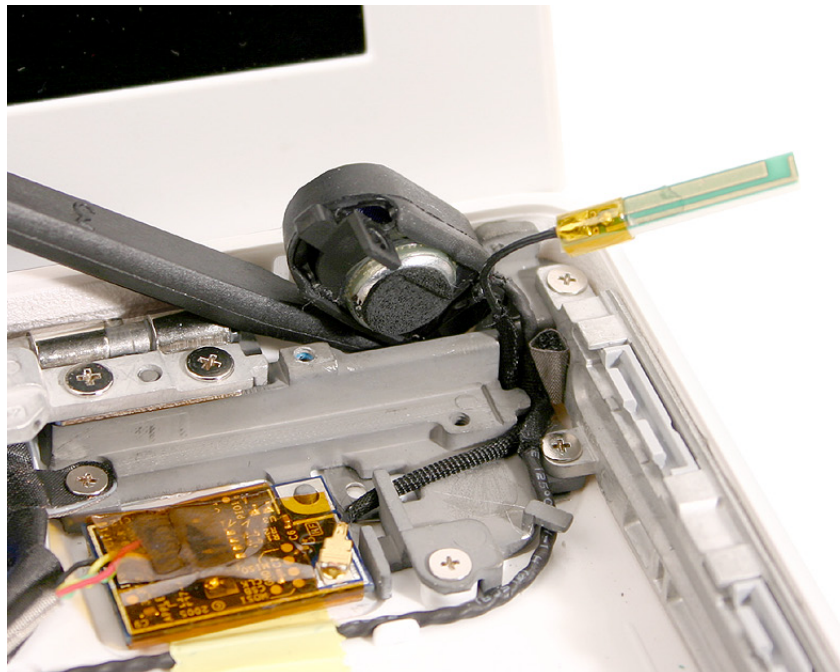

3. Unroute the thin Bluetooth cable and the black speaker cable.

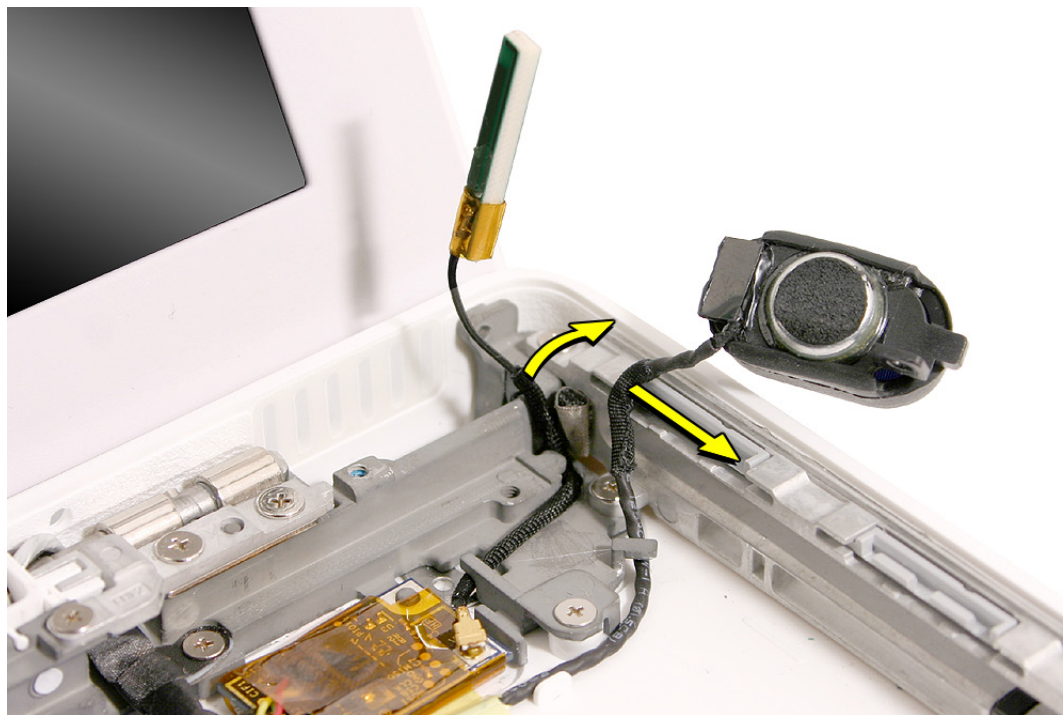
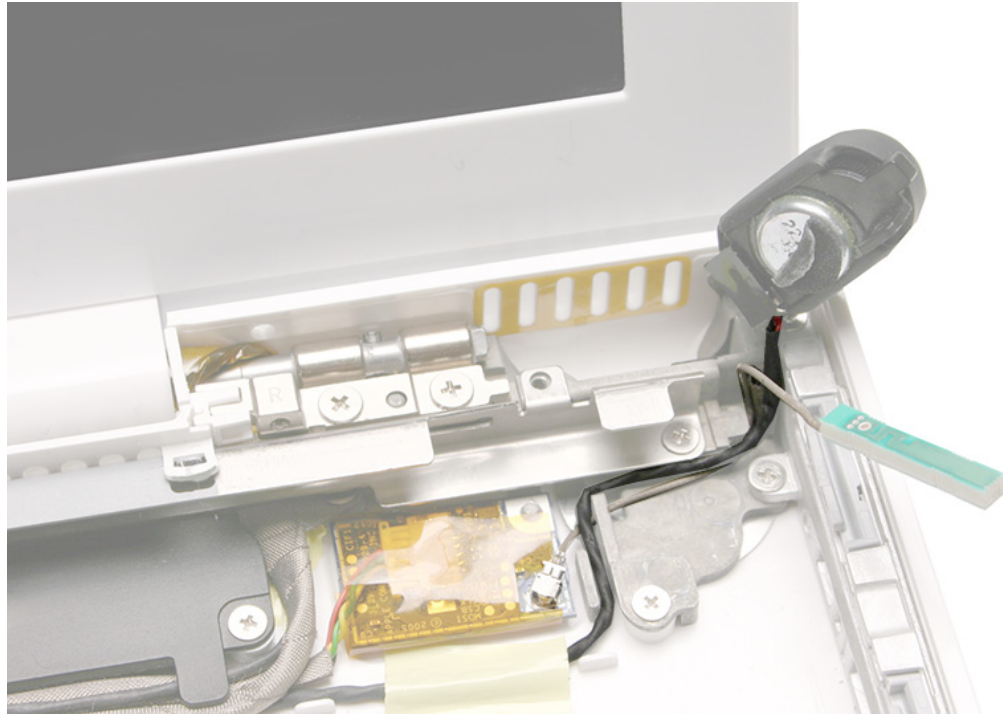

- Using a black stick, disconnect the Bluetooth antenna cable from the lower right corner of the Bluetooth board. Pry the connector straight up.

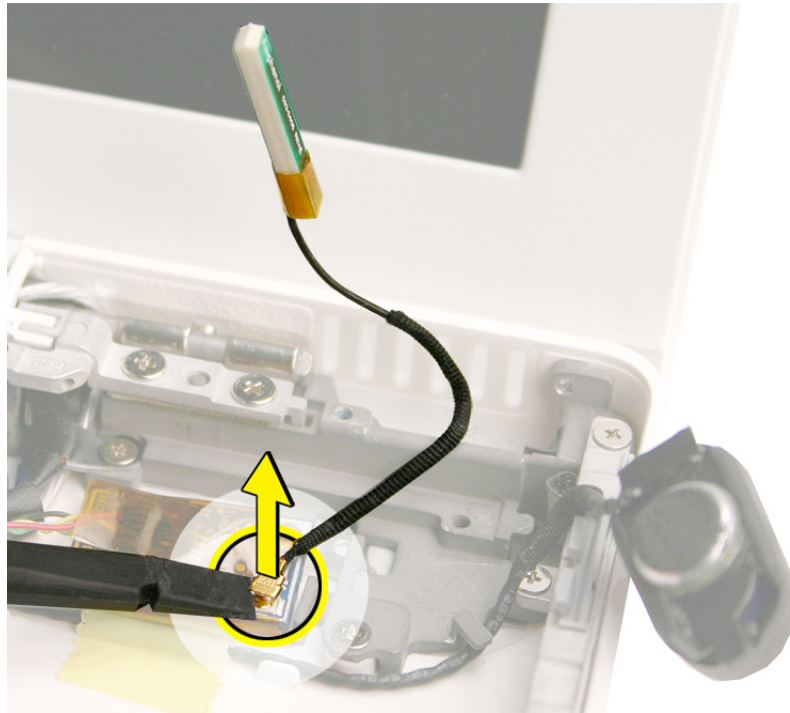

- Install the replacement Bluetooth antenna board and cable.

**Replacement Caution:** To prevent a pinched or damaged cable, make sure the cable is routed through the cable guides, as shown.

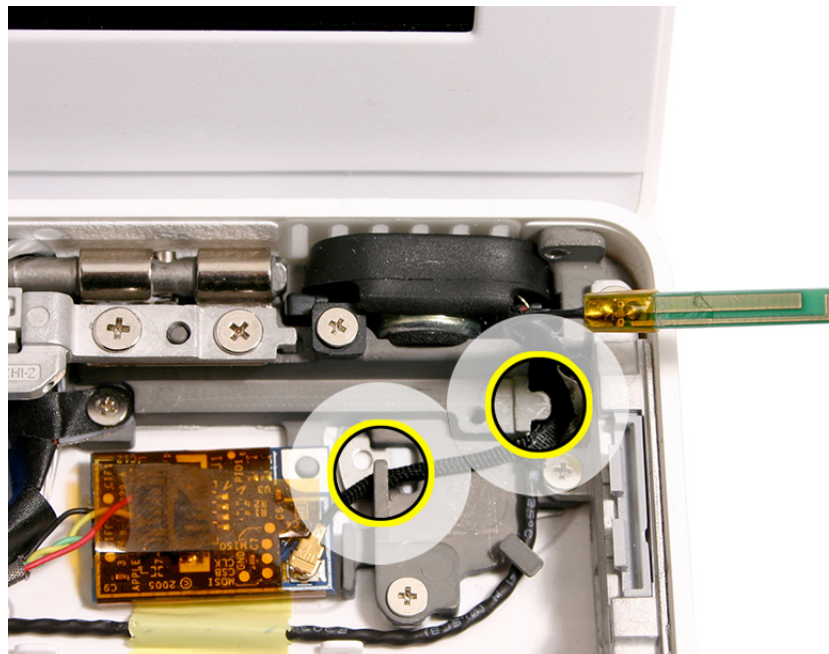



# Bluetooth Board

## Tools

- ESD wrist strap and mat
- Black stick (Apple part number 922-5065) or other nonconductive nylon or plastic flatblade tool

## Preliminary Steps

Before you begin, remove

- [Battery](#)
- [RAM door](#)
- [Top case with keyboard](#)
- [Optical drive](#)

## Part Location

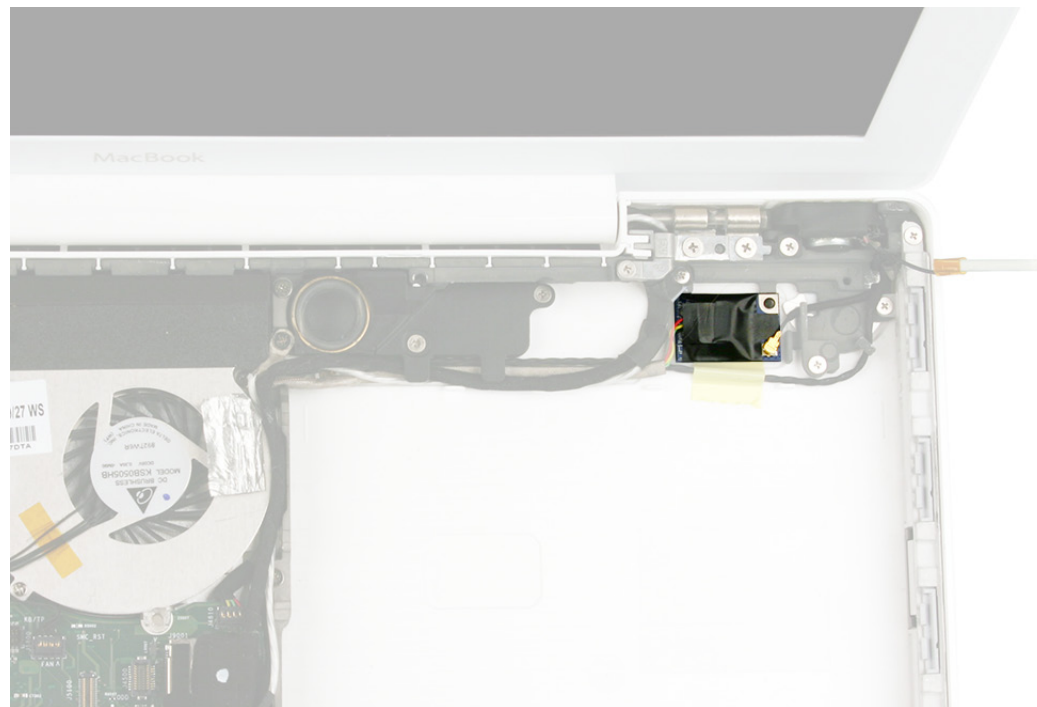

---

## Procedure

**Caution:** During this procedure and when applying a replacement Bluetooth board, do not press on the center of the board. The only acceptable area to press on is the right corners of the board near the locator pin and the Bluetooth antenna cable connector.

**Important:** The Bluetooth board is adhered to the bottom case with double-sided tape. Before removing the Bluetooth board, note the cable routing near the Bluetooth board.

1. Using a black stick, disconnect the Bluetooth antenna cable from the lower right corner of the board. Pry the connector straight up.

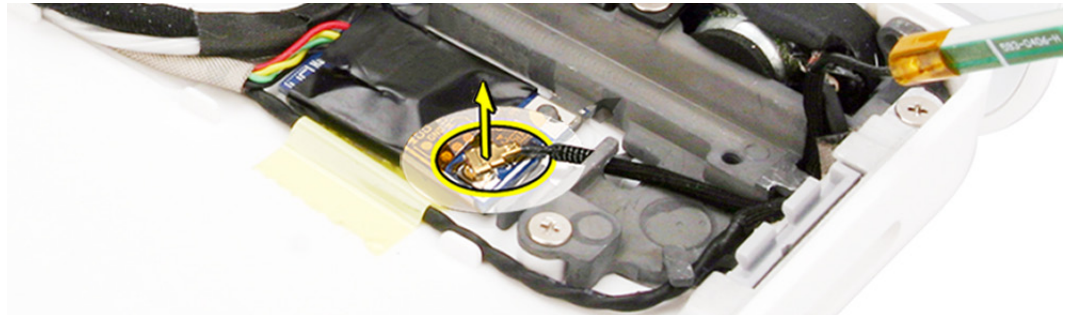

2. Use a black stick to gently loosen the adhesive and lift the board off the bottom case.

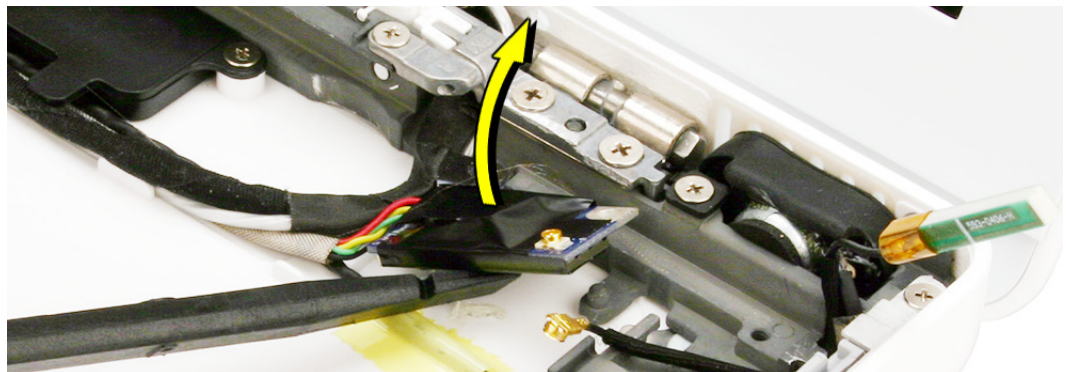

3. Lift black mylar tab to disconnect the Bluetooth cable from the Bluetooth board.



---

**Replacement Note:** Without straining the Bluetooth-to-logic board cable, slide a black stick underneath the board sleeve, and insert and press the connector to secure it to the board.

**Replacement Note:** Connect the Bluetooth-to-logic board cable first before adhering the board to the bottom case. Then install the Bluetooth antenna cable, and make sure the cable exits toward the upper right corner of the bottom case.

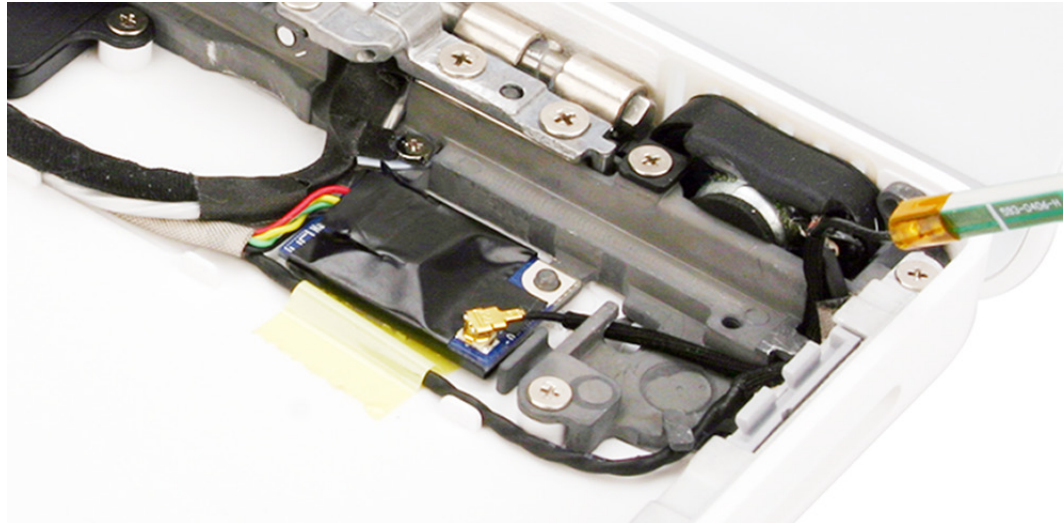

**Replacement Note:** Make sure the upper right corner of the board fits over the locator pin. To secure the board, press only the right corners of the board near the locator pin and the Bluetooth antenna cable.

4. Install the replacement Bluetooth board, and reassemble and test the computer.

**Replacement Note:** If installing a new Bluetooth board, remove any remaining adhesive from the bottom case. Then remove the adhesive backing from the new board before installing it in the bottom case.



# Bluetooth-to-Logic-Board Cable

## Tools

- ESD wrist strap and mat
- Black stick (Apple part no. 922-5065) or other nonconductive nylon or plastic flatblade tool

## Preliminary Steps

Before you begin, remove

- [Battery](#)
- [RAM door](#)
- [Top case with keyboard](#)
- [Optical drive](#)
- [Bluetooth board](#)

## Part Location

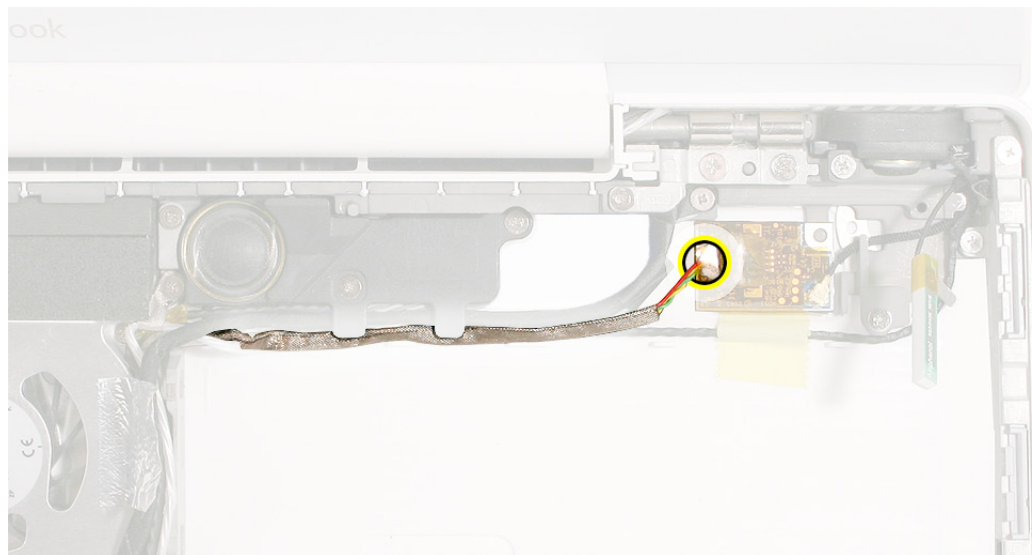

---

## Procedure

**Note:** The photography below may differ from the actual unit you are repairing; however, the actual procedure remains the same.

**Important:** During this procedure and when applying a replacement Bluetooth-to-logic-board cable, do not press on the center of the Bluetooth board. The only acceptable area to press on is the right corners of the board near the locator pin and the Bluetooth antenna cable.

1. Carefully move aside any cables that block the Bluetooth-to-logic-board cable path.

**Warning:** The subwoofer cone is a sensitive device. Avoid touching the subwoofer cone.

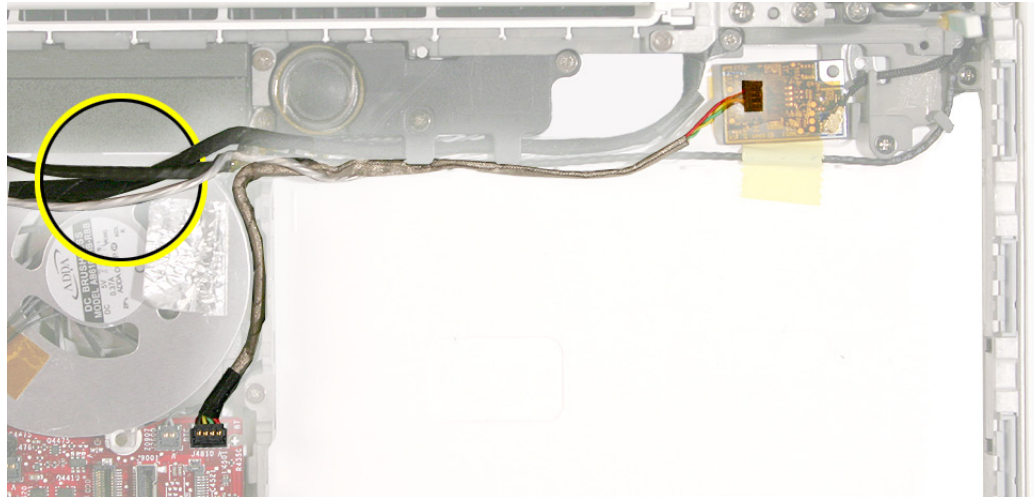

2. Disconnect the cable from the Bluetooth board.



3. With the Bluetooth cable disconnected from the Bluetooth board, route the Bluetooth cable underneath the silver microphone cable.

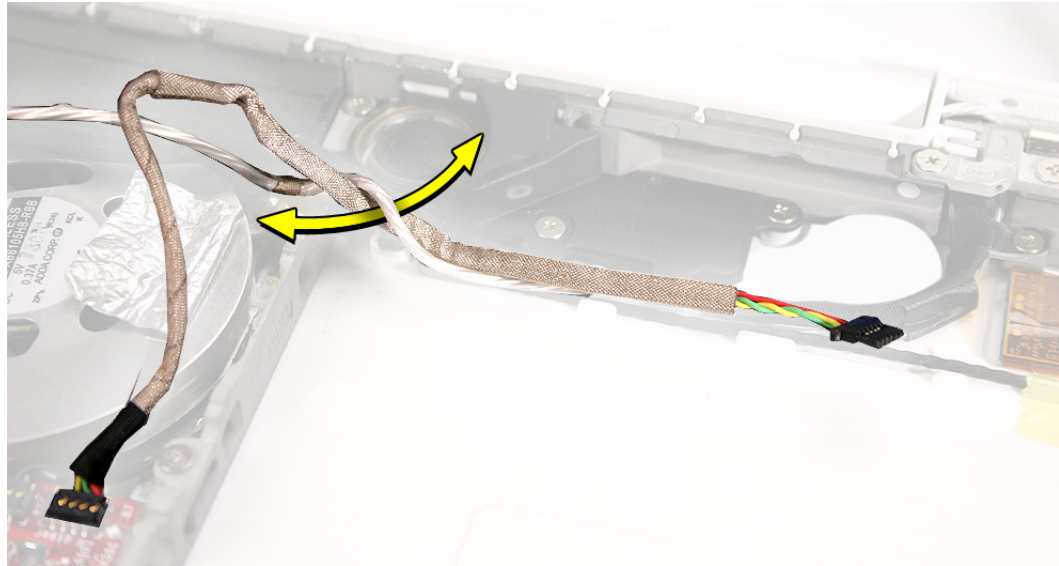

4. Use a black stick and your finger to disconnect the connector from the logic board.

**Note:** Ensure the JST connector stays level as you disconnect it and later reinstall it.



- 
5. Install a replacement Bluetooth-to-logic-board cable, and reassemble and test the computer.



**Replacement Note:** With the cable attached to the Bluetooth board, install the cable under the subwoofer tabs before routing the cable to the logic board. Make sure the cable routing appears as shown before reconnecting the remaining cables to the logic board.

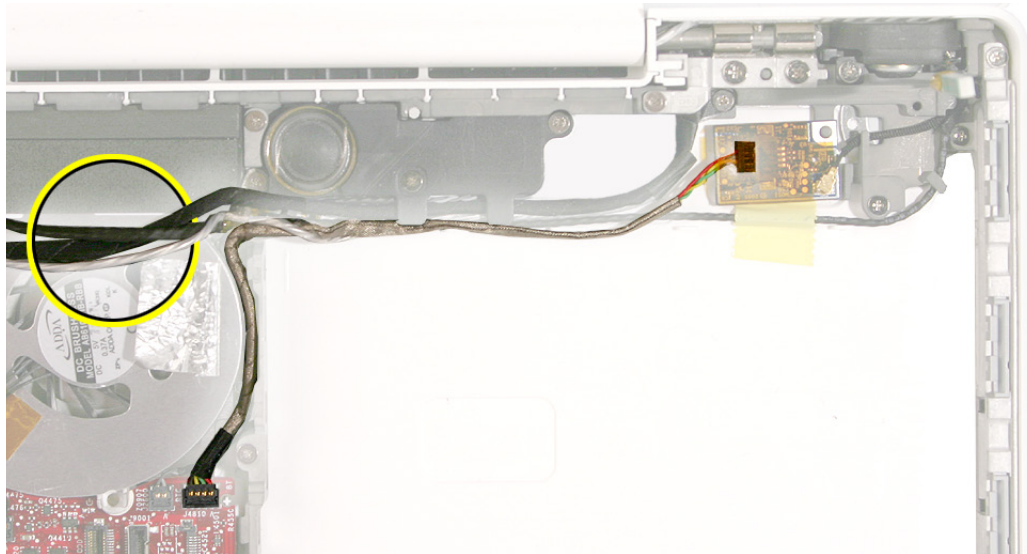



# Subwoofer with Right Speaker Cable

## Tools

- ESD wrist strap and mat
- Magnetic Phillips #0 screwdriver
- Black stick (Apple part number 922-5065) or other nonconductive nylon or plastic flatblade tool

## Preliminary Steps

Before you begin, remove

- [Battery](#)
- [RAM door](#)
- [Top case with keyboard](#)
- [Optical drive](#)

## Part Location

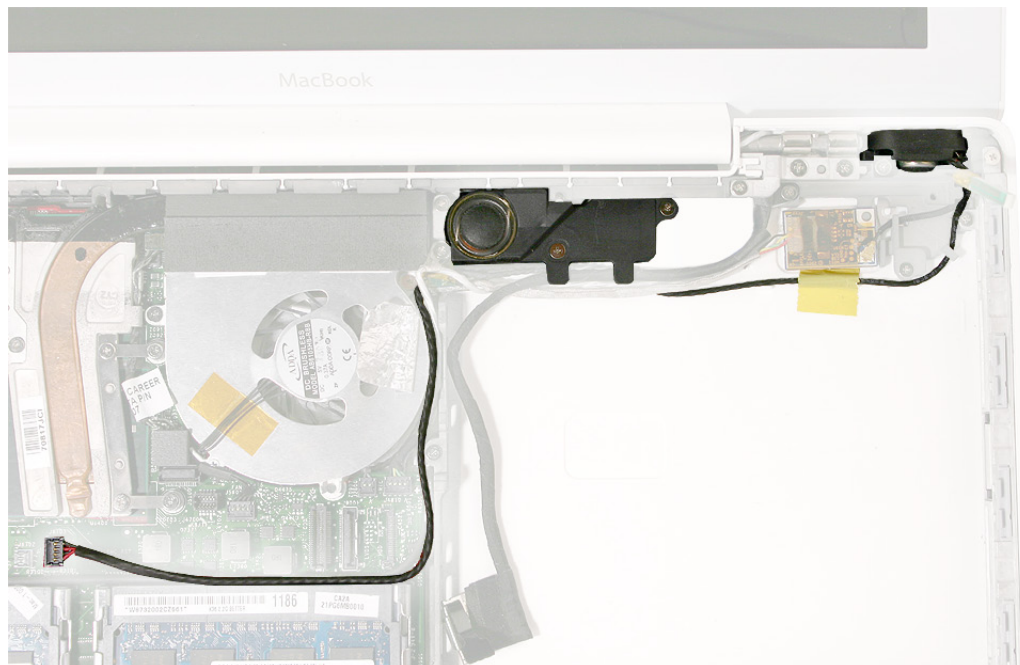

---

## Procedure

**Warning:** The subwoofer cone is a sensitive device. Avoid touching the subwoofer cone.

1. Note the cable routing for the right speaker, and remove the 3.5-mm long screw at the speaker.

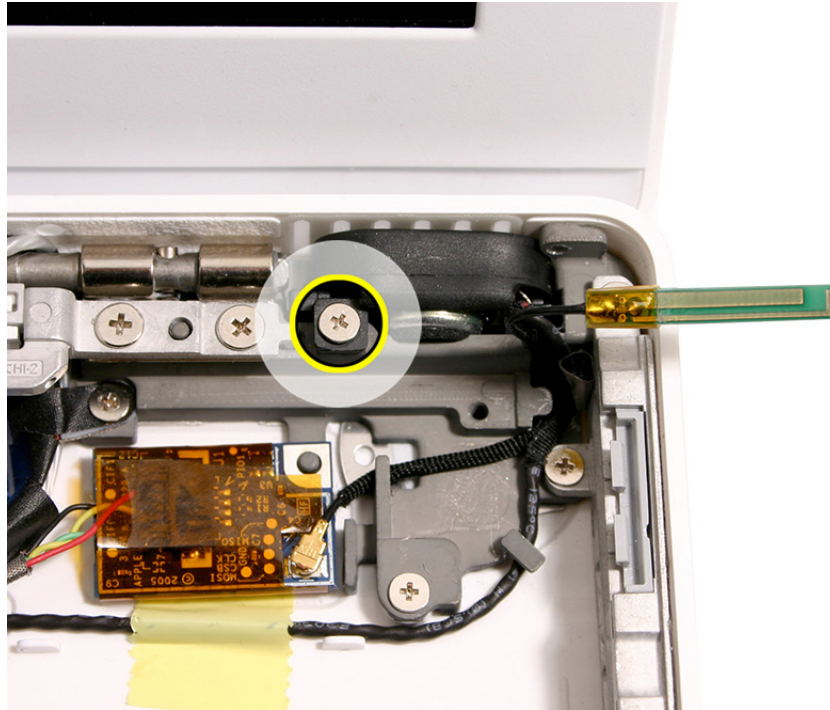

2. Tilt up the speaker.

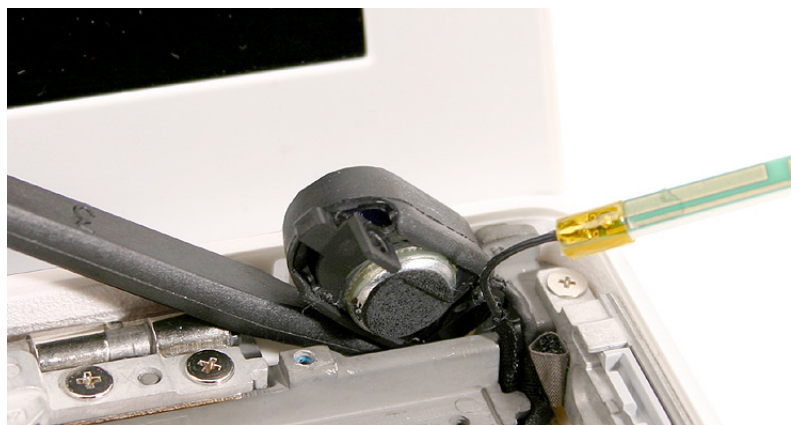

3. Tilt up the right speaker from the top right corner of the computer assembly, and without straining the speaker cable, unroute it from the cable guides.

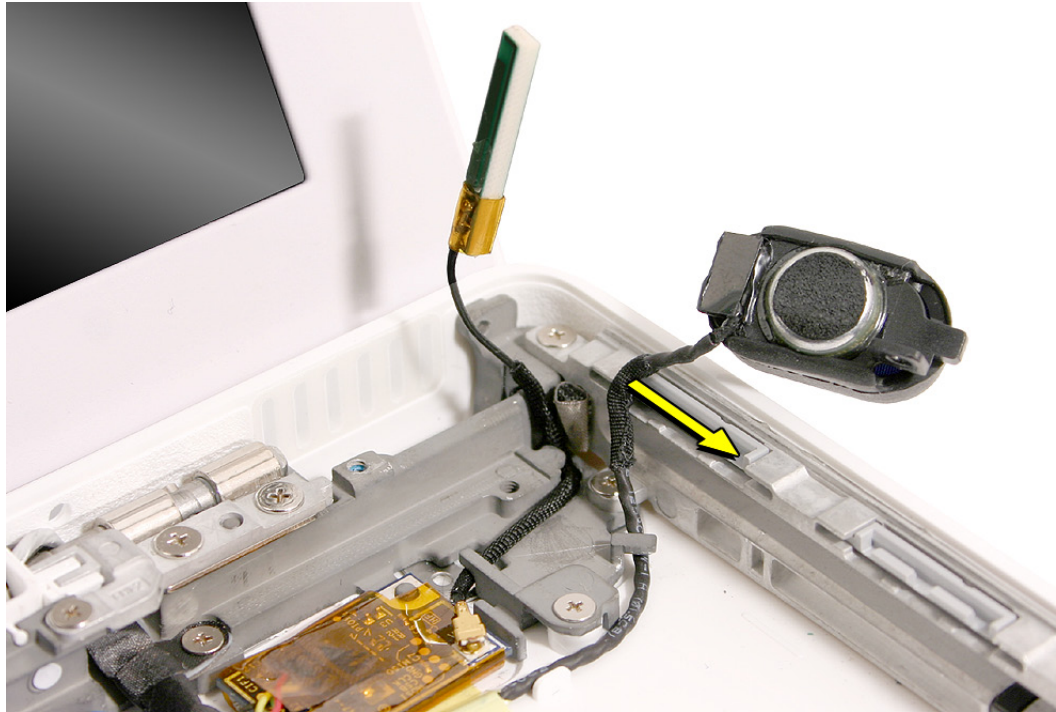

4. Remove the three identical 3-mm long screws from the subwoofer, and peel up the tape from the bottom case.

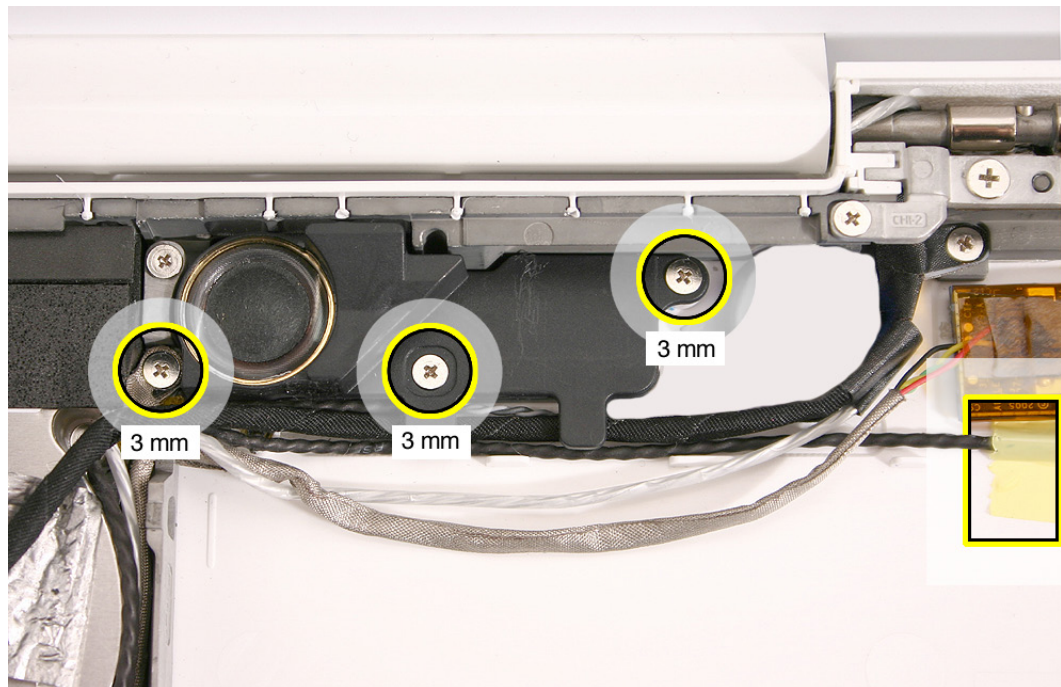

5. **Warning:** The subwoofer cone is a sensitive device. Avoid touching the subwoofer cone. To prevent excessive pressure on the subwoofer body, hold it by the edges as you perform this step.

Unroute the speaker cable, and while holding the sides of the subwoofer, move the subwoofer body away from the rear panel.

6. Separate the subwoofer ground tab from underneath the microphone ground tab.

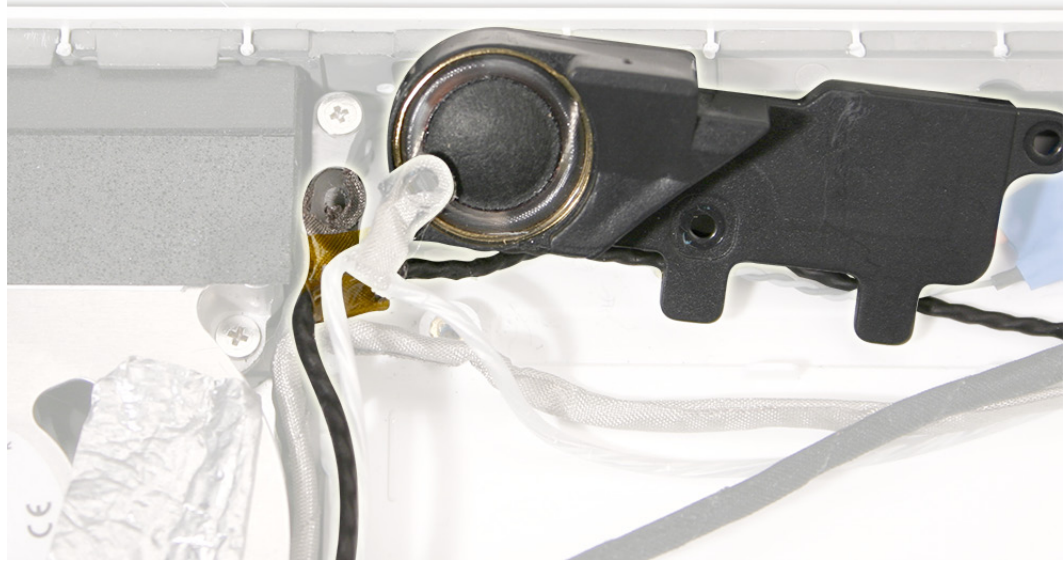

7. Disconnect the 4-pin speaker cable from the logic board connector, just over the memory card slots.

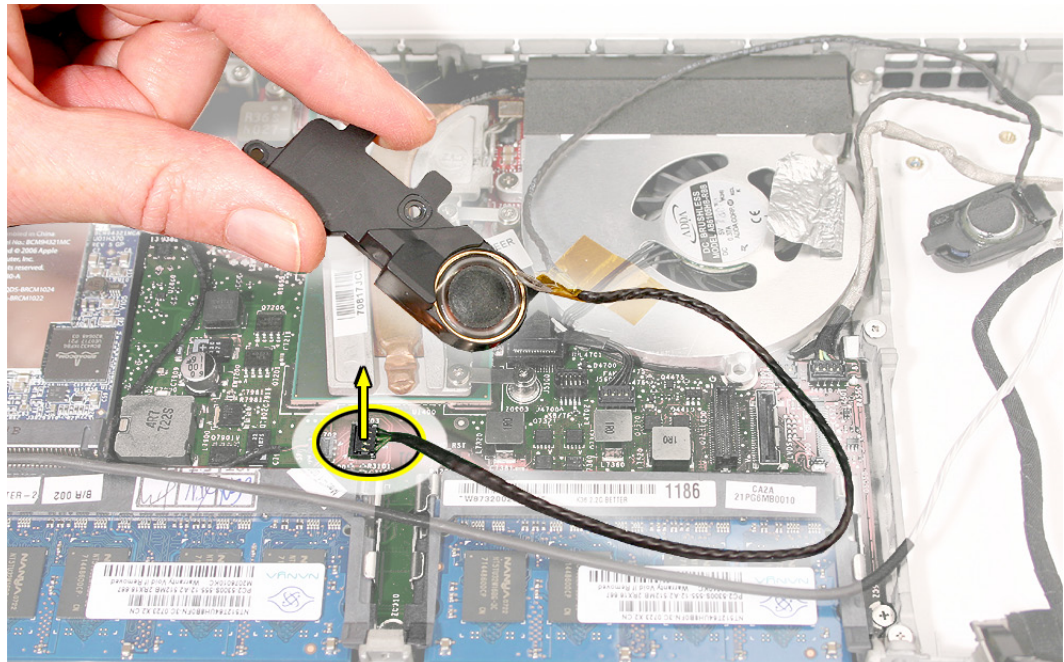

8. **Replacement Note:** When connecting the right speaker cable to the logic board, make sure the cable runs securely
  - over the right memory slot
  - between the optical drive cable connector and the LVDS cable connector
  - under the Bluetooth connector
  - between the fan and the midframe
9. **Replacement Note:** Before installing the subwoofer, check the bottom case to make sure the microphone cable is to the right of the LVDS cable, between it and the Bluetooth board.
10. **Replacement Note:** Before securing the subwoofer screws, place the subwoofer into the bottom case, but tilt it up slightly to tuck these cables under the subwoofer tabs and above the raised tabs on the bottom case:
  - Backup battery cable first
  - Microphone cable second
  - LVDS cable third
  - Bluetooth cable fourth
  - Speaker cable fifth
  - no cables obscure the subwoofer screw posts on the bottom case
  - the right speaker cable is routed correctly in the right corner of the bottom case and is taped where shown.

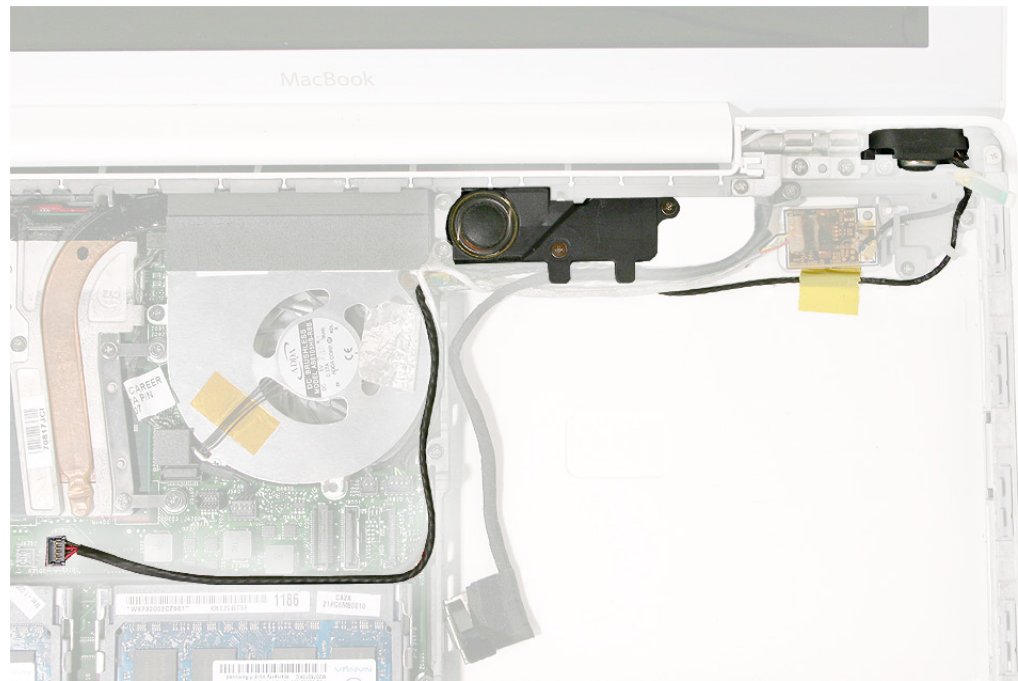

**Replacement Note:** Install the subwoofer screws only when you are sure that the cables cannot be pinched and are in the orientation specified. After the subwoofer screws are installed, install the grounding screws and tabs on the midframe.

- 
11. Install the replacement subwoofer with right speaker cable, and reassemble and test the computer.





# Midframe

## Tools

- ESD wrist strap and mat
- Magnetic Phillips #0 screwdriver
- Black stick (Apple part number 922-5065) or other nonconductive nylon or plastic flatblade tool

## Preliminary Steps

Before you begin, remove

- [Battery](#)
- [RAM door](#)
- [Top case with keyboard](#)
- [Optical drive](#)

## Part Location

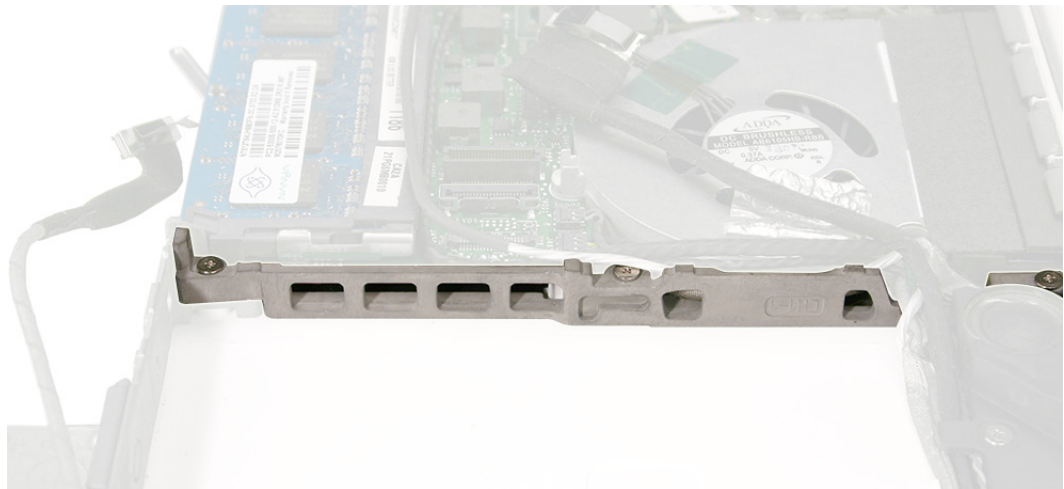

## Procedure

1. Note the orientation of the cables that route over the midframe.
2. Remove the screws:
  - three 7.5-mm long screws (middle and each end of the midframe)
  - 3-mm long ground screw
  - 3-mm long fan screw

**Warning:** The subwoofer cone is a sensitive device. Avoid touching the subwoofer cone.

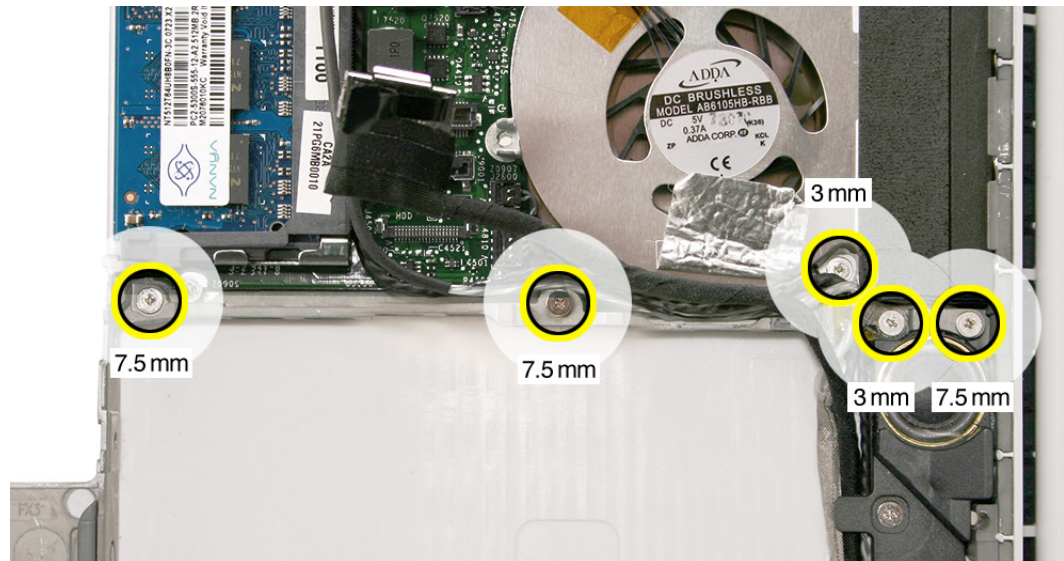

3. Without straining the cables, use a black stick to hold the cables aside as you pivot the midframe to remove it from the bottom case.

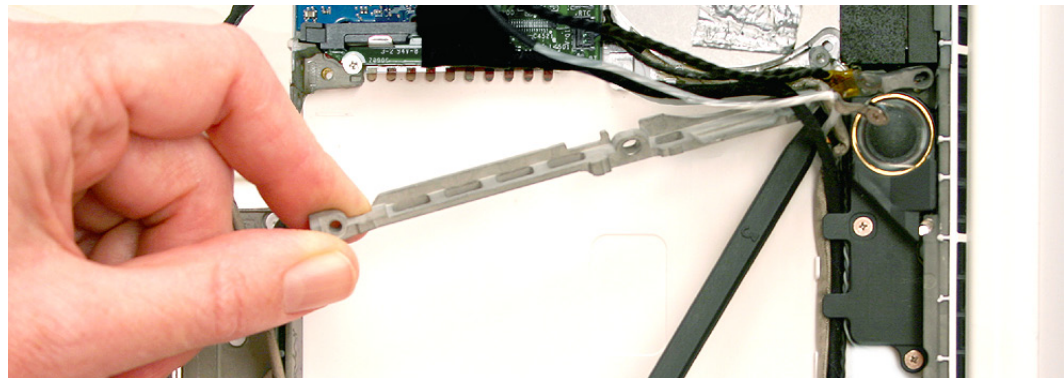

4. Install the replacement midframe, and reassemble and test the computer.





# Logic Board

## Tools

- ESD wrist strap and mat
- Magnetic Phillips #0 screwdriver
- Black stick (Apple part no. 922-5065) or other nonconductive nylon or plastic flatblade tool
- Stack of books, weighted boxes, or other means of support for display while removing and replacing left clutch block
- Alcohol wipes
- Thermal grease (Apple part number 922-7144)
- Felt-tip pen

## Preliminary Steps

Before you begin, remove

- [Battery](#)
- [RAM door](#)
- [Memory cards](#)
- [Top case with keyboard](#)
- [AirPort Card](#)
- [MagSafe DC-in board](#)
- [Left speaker](#)
- [I/O frame](#)
- [Fan](#)
- [Heatsink](#)

## Part Location

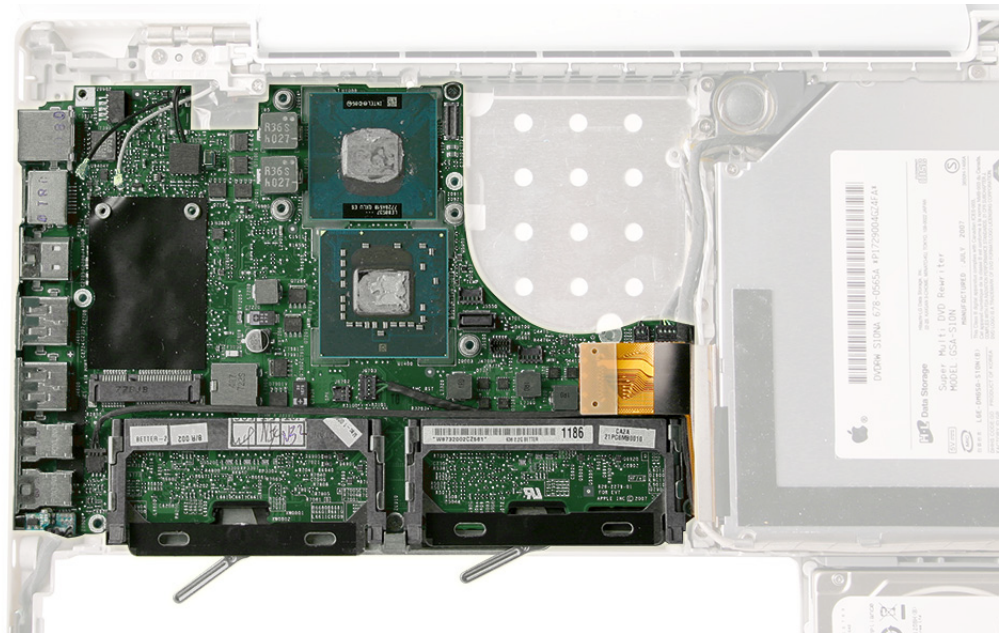

## Procedure

**Caution:** When servicing the computer, be especially careful when working near the gold spring on the logic board, located above the AirPort Extreme Card. Although the spring is flexible, it can be inadvertently torn, bent, or broken if a cable gets caught on it. A logic board might be rendered unusable with a damaged spring. Check the structural integrity of the spring before completing a repair.

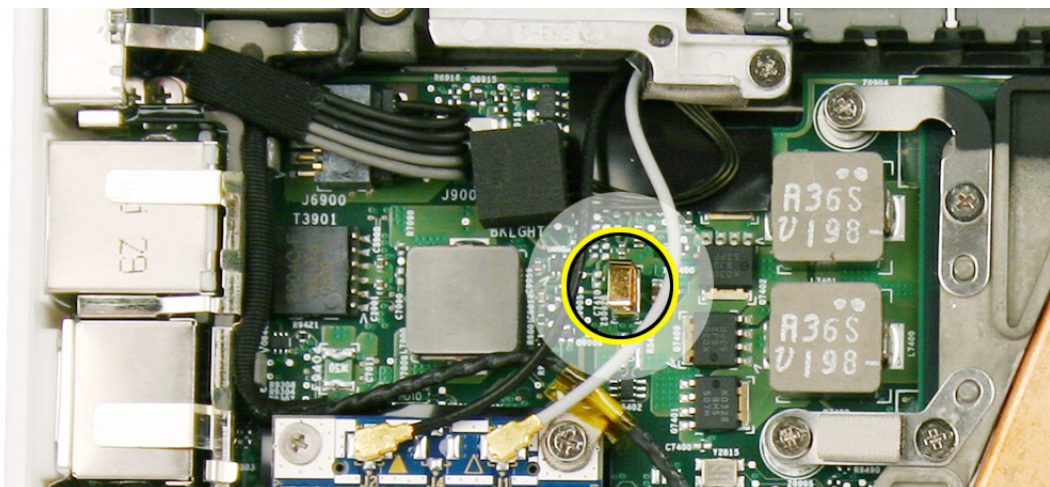

1. Disconnect the optical drive flex cable from the logic board.

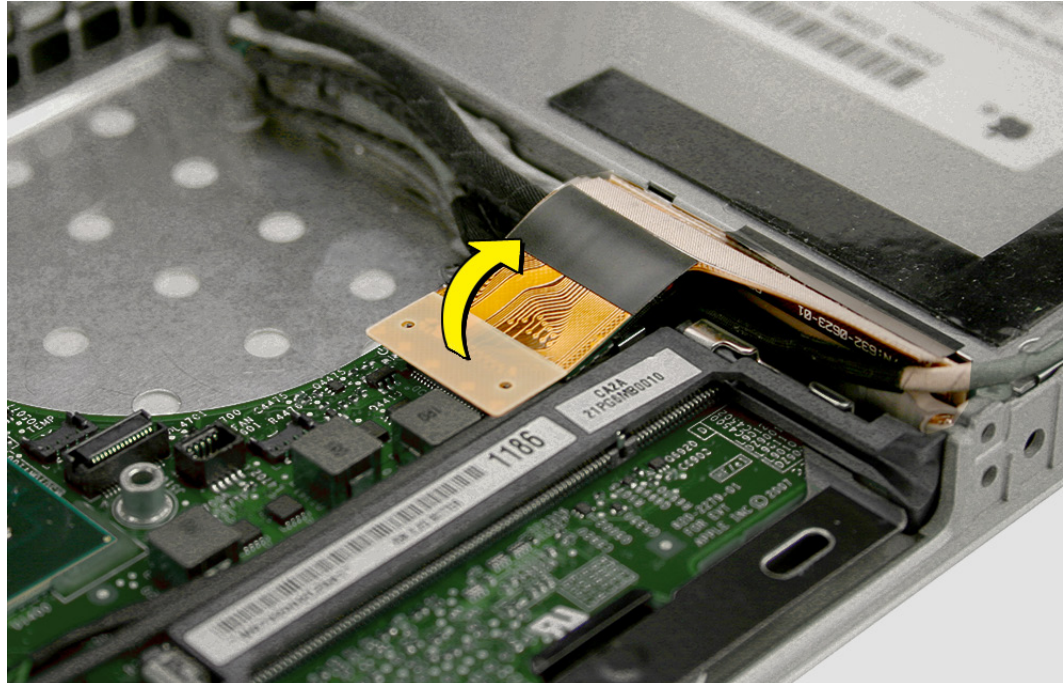

2. Without straining the optical drive flex cable, pull the pull-tab to disconnect the LVDS cable from the logic board.

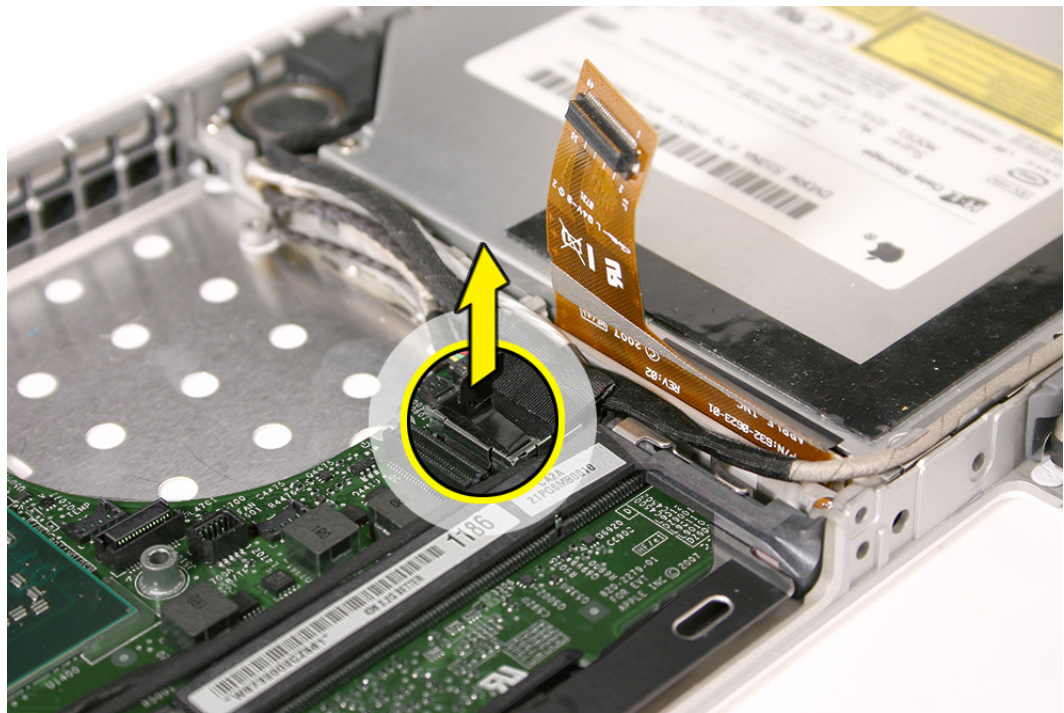

3. Disconnect the following connectors from the logic board:
  - Bluetooth cable JST connector (**Note:** Make sure use your finger and a black stick to keep the connectors level when disconnecting them.)
  - hard drive cable connector.

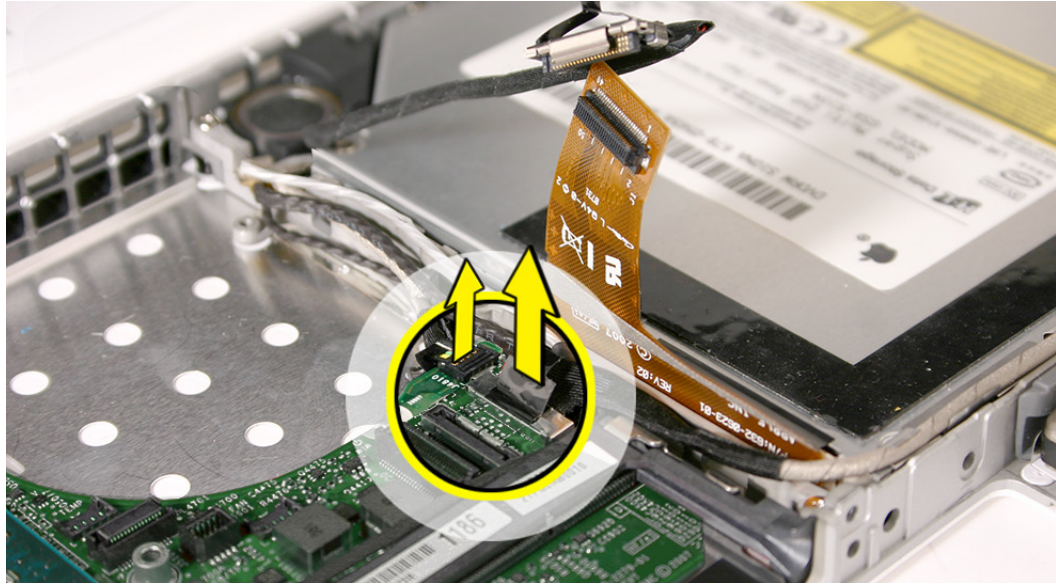

4. Remove the two 3-mm long screws located by the memory card carriers, and disconnect the following cables:
  - sleep switch connector (use a black stick to raise up and disconnect it)
  - microphone cable (use a black stick to raise up and disconnect it)
  - subwoofer/right speaker cable

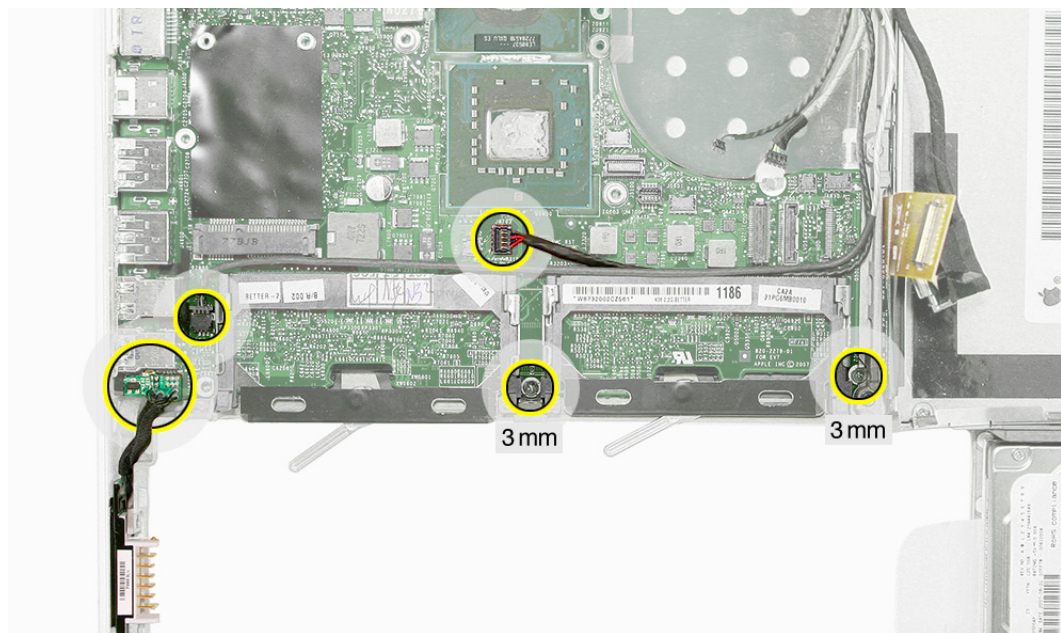

5. Place a heavy box behind the display to help support it (refer to “Clutch Block, Left” for more details). Disconnect the inverter cable, and remove the following:
  - 10.5-mm long thick-stemmed outer screw, closest to the left corner of the bottom case
  - 5.5-mm long thick-stemmed middle screw
  - 8-mm long thin-stemmed inner screw, closest to the antenna cables
  - 3.5-mm long screw from the upper right area of the board
  - foam sponge over inverter connector

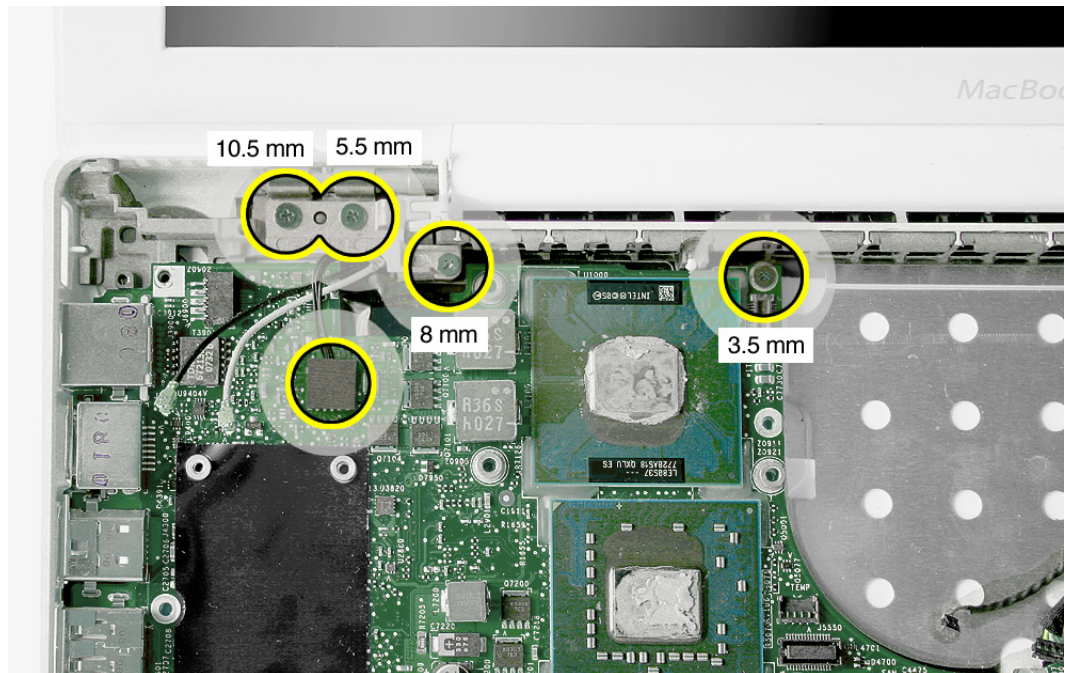

6. Disconnect the inverter cable (use a black stick to raise up and disconnect it).

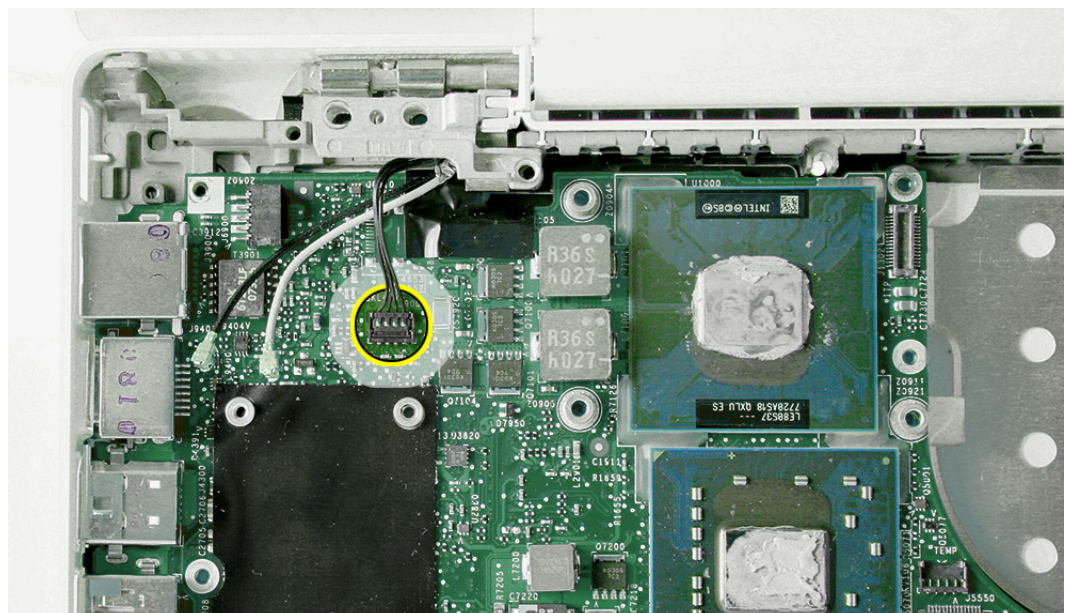

7. Remove the left clutch block and clutch cap, and carefully move aside any cables that overlap the logic board.

**Replacement Note:** When reinstalling the clutch block, refer to “Clutch Block, Left” in this chapter.

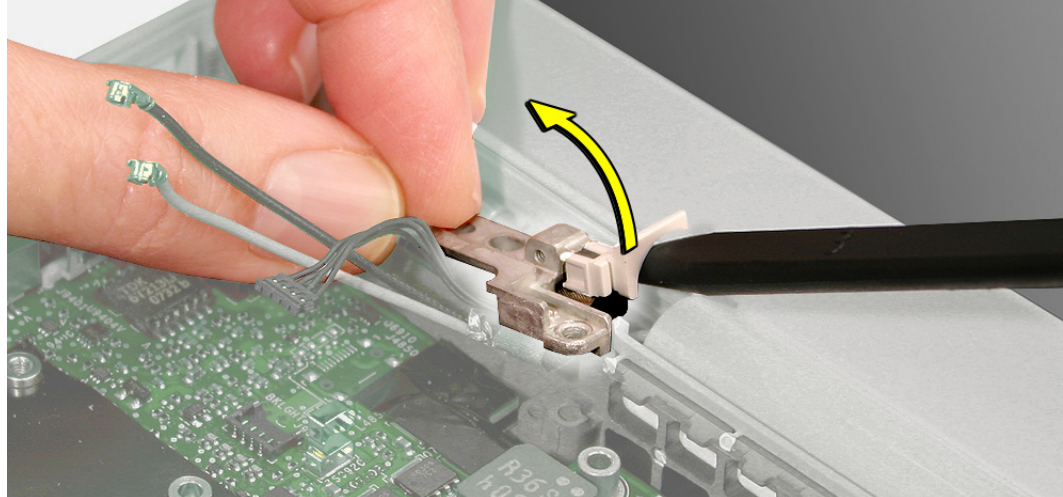

8. Holding the logic board by its right side, tilt it up, and with a small rocking motion, remove it at an angle away from the I/O ports. You might find it helpful to use a black stick between the side of the bottom housing and the ports.

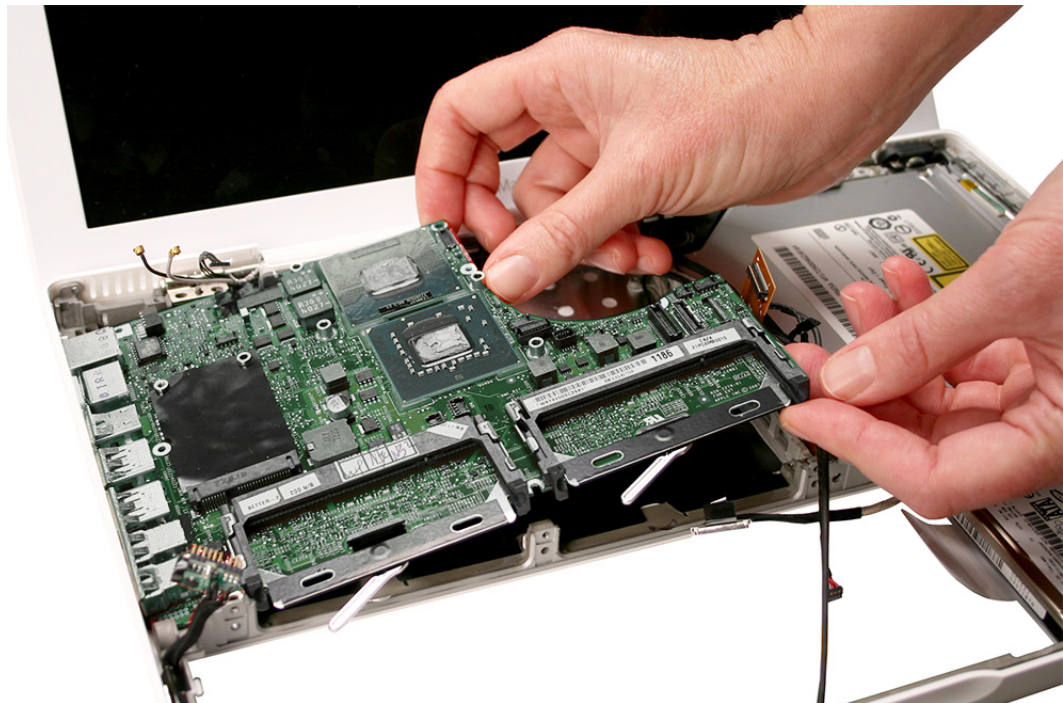

**Replacement Note:** When replacing the logic board, make sure all cables are kept clear of the board, and the I/O shield is securely positioned along the ports.

9. If you are installing a new logic board, transfer the following parts to the replacement board:
  - Tape at the edge of the board between the inverter connector and the large chip
  - AirPort Extreme Card
  - Memory cards
  - I/O shield

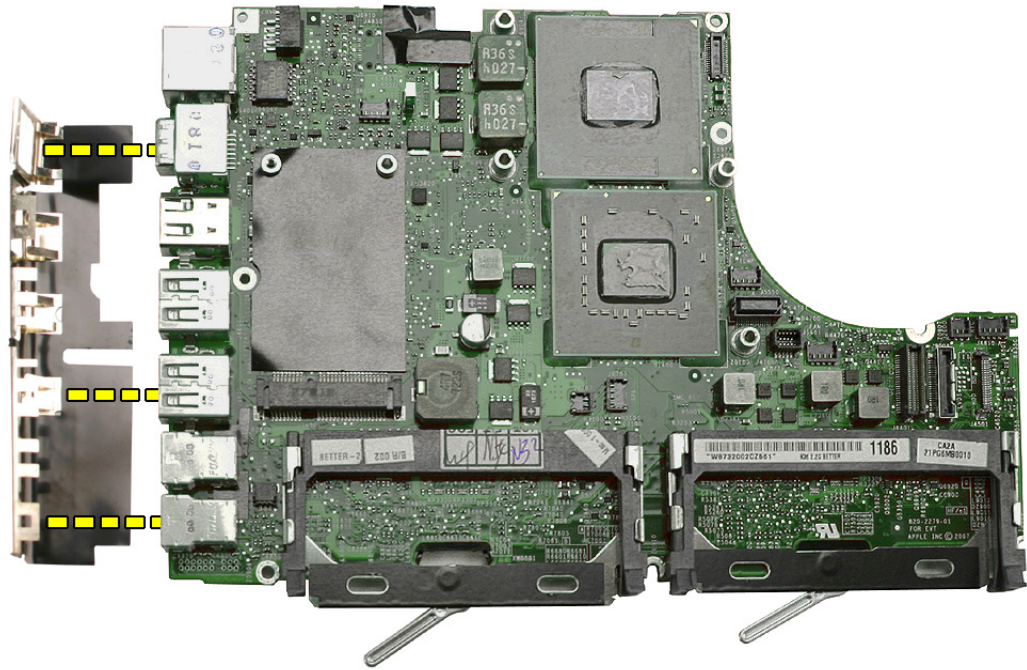

10. Before installing the logic board, make sure the gold spring is intact (not bent or broken).

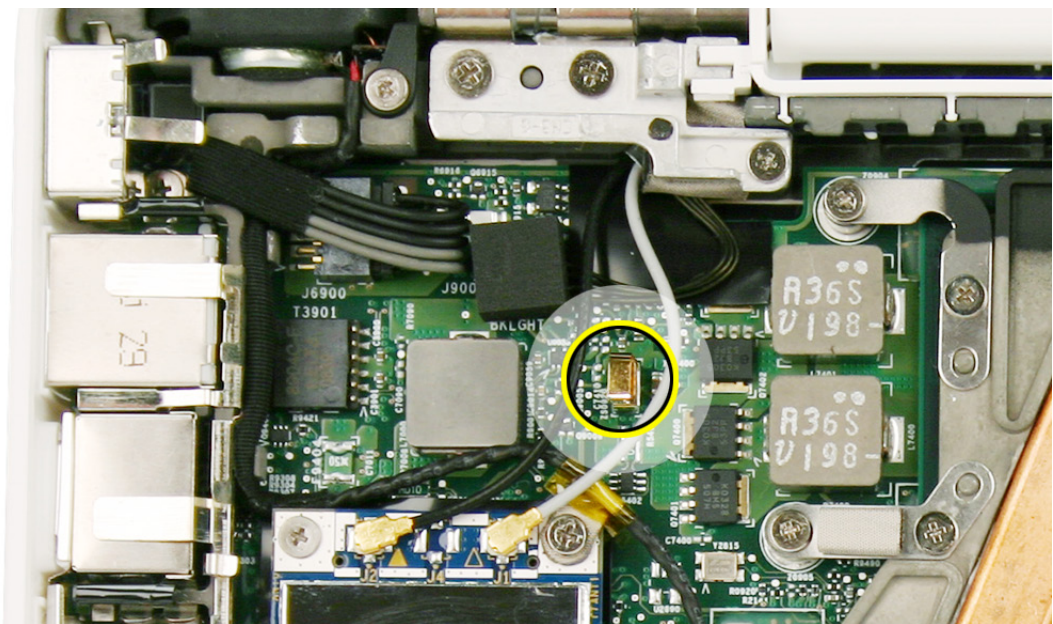

11. Before installing the logic board, check the locator pins on the bottom case. Make sure the two openings in the logic board fit over the “+”-shaped locator pins.

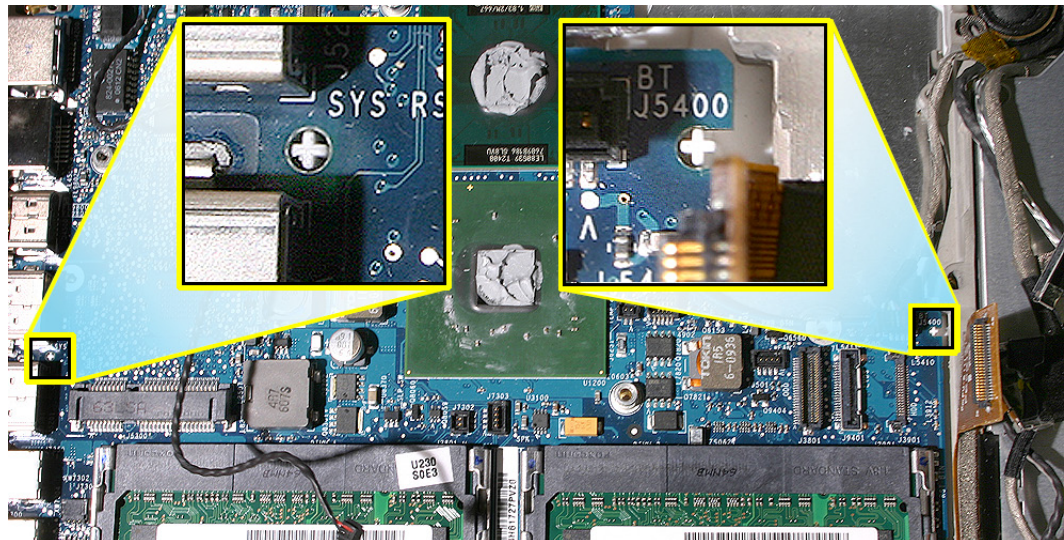

12. **Warning:** Whenever the heatsink is separated from the logic board (even if you are installing the same logic board or heatsink), the thermal grease must be checked and possibly replaced. Failure to do so can cause the computer to overheat and be damaged. Refer to “Checking the Thermal Grease” in the Heatsink section.
13. **Important:** When replacing the logic board, make sure the arrangement of pins on the battery connector/sleep switch exactly match the pin openings on the logic board. If the sleep switch cable does not match the logic board, discard the cable and order the correct matching cable.
14. Install the replacement logic board, and reassemble and test the computer.

**Replacement Note:** Before replacing the top case, make sure the two foam sponges are in place.

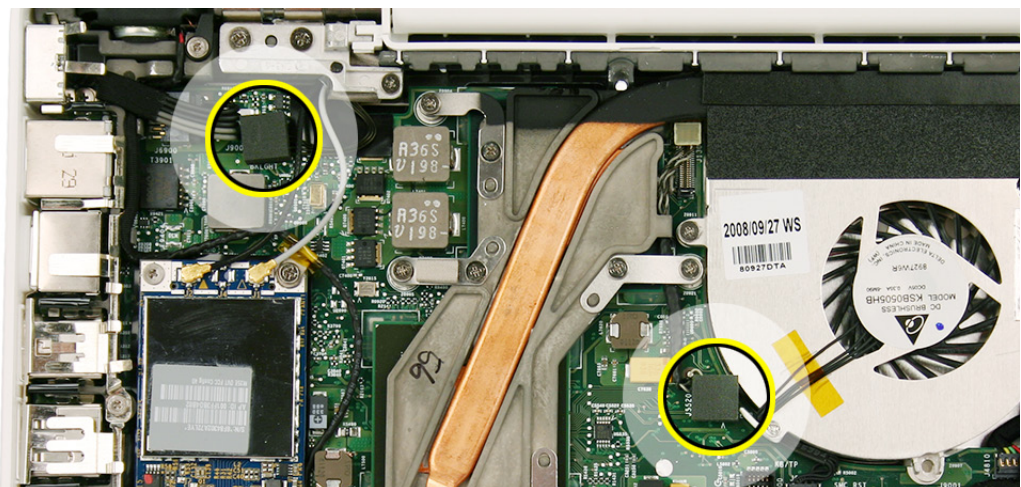



# Display Bezel

## Tools

- ESD wrist strap and mat
- Black stick (Apple part number 922-5065) or other nonconductive nylon or plastic flatblade tool
- Access card (Apple part number 922-7172)

## Preliminary Steps

None

## Part Location



---

## Removal Procedure

1. With the display open wider than a 90-degree angle, run an access card along the outer sides and top edge of the bezel where it meets the display rear housing.



**Note:** When opening the bezel, you might find that a small dot of adhesive is used at the top corner:

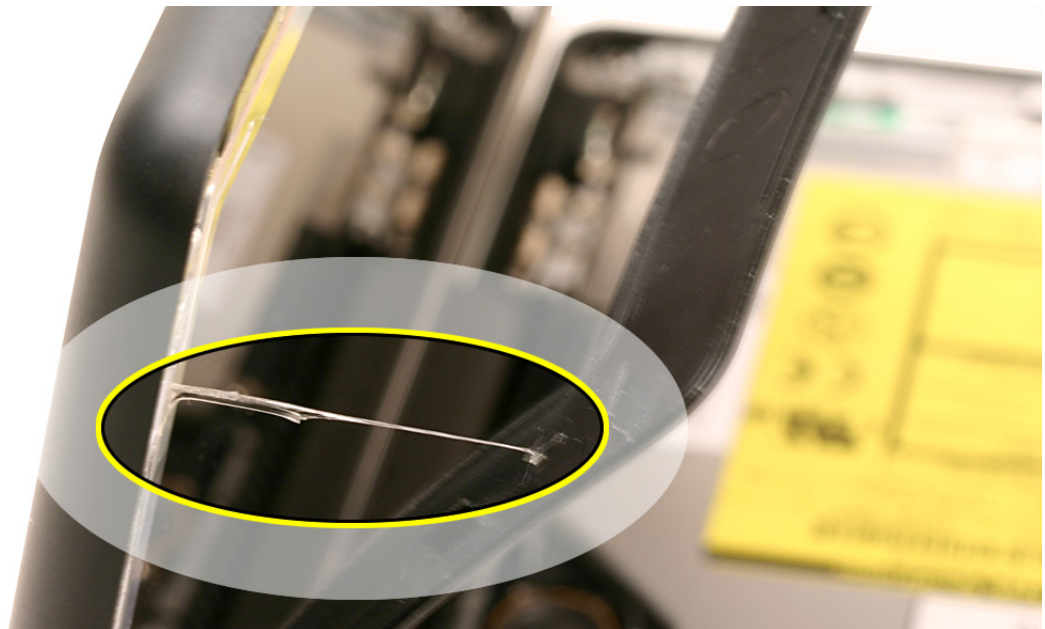

2. To loosen the bottom of the bezel, run a black stick along the inner edge where the bezel meets the LCD frame. Do not touch the display face.



**Note:** If you have a plastic sheet that can protect the LCD panel, cover the display face.

3. Lift off the bezel.
4. Check for any mounting clips around the LCD frame that pop off or appear to be missing.

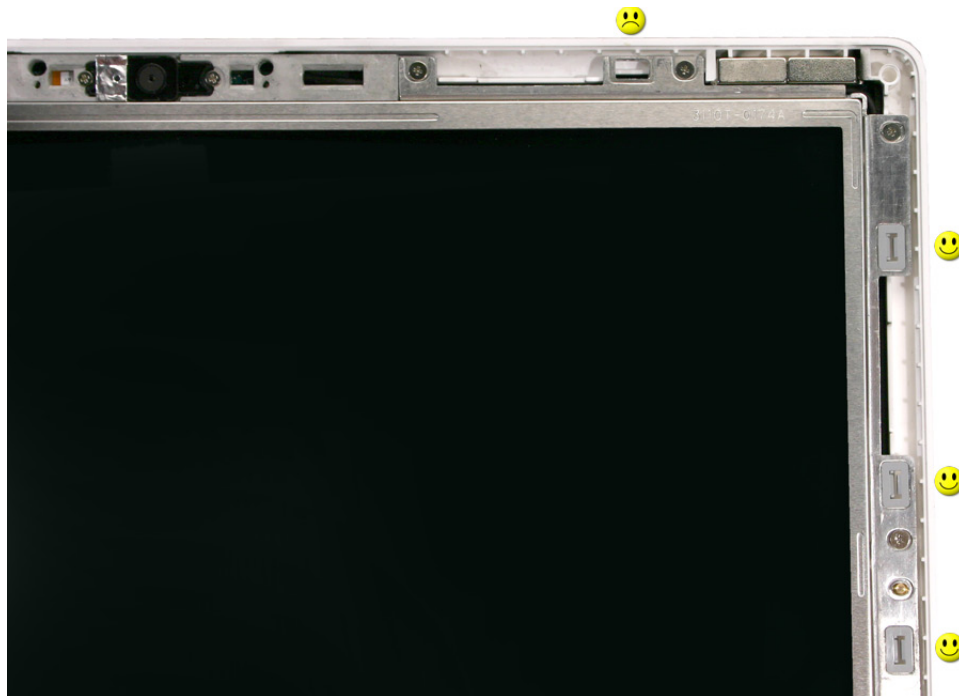

- Return any clips back into the bezel brace.

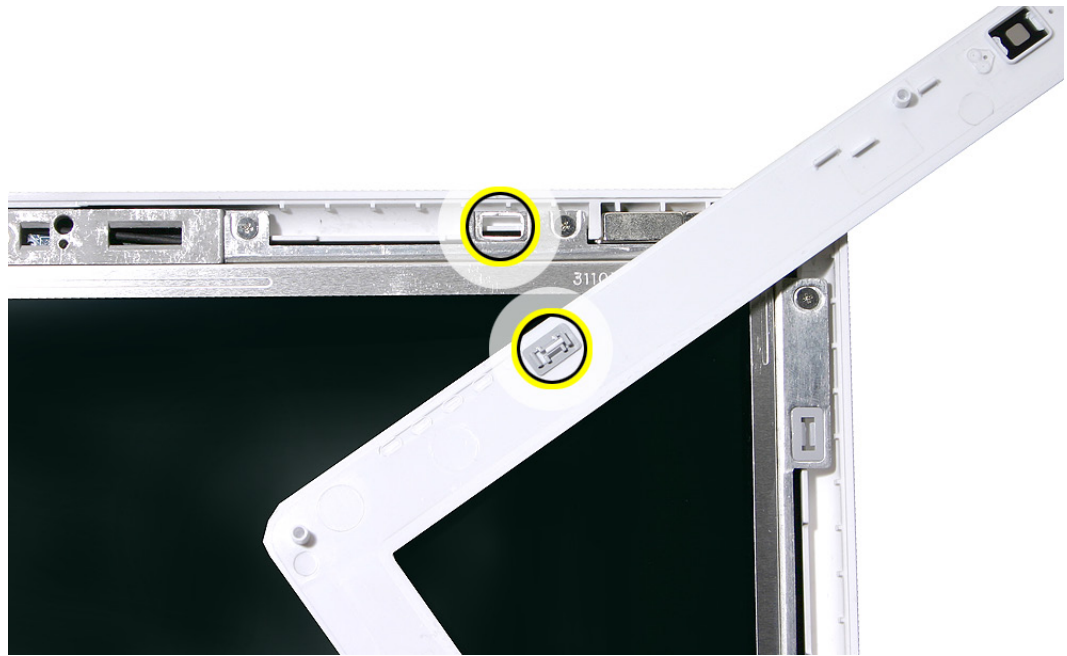

- If any of the mounting clips are difficult to install, check that they are structurally sound. You can order a kit of replacement clips if necessary.

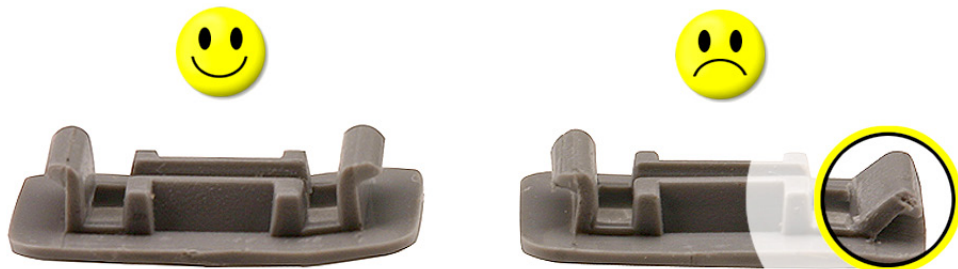

- Install the replacement bezel (first see notes in the Replacement Procedure), and reassemble and test the computer.

---

## Replacement Procedure

**Important:** Before installing a replacement bezel, be sure to check the camera area, and peel off the dust cover film that comes with a new bezel.

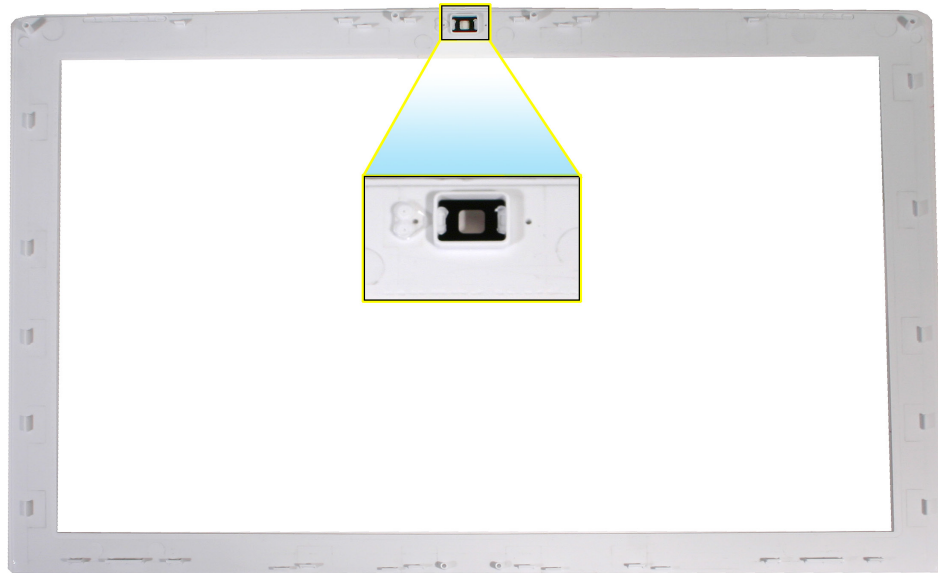

**Replacement Caution:** The lower corners of the bezel include mounting hooks that differ in design from the snaps at the top and sides of the bezel. Incorrectly installing this area of the bezel can result in bent hooks and a bezel gap that would require bezel replacement. These hooks must be installed as follows.

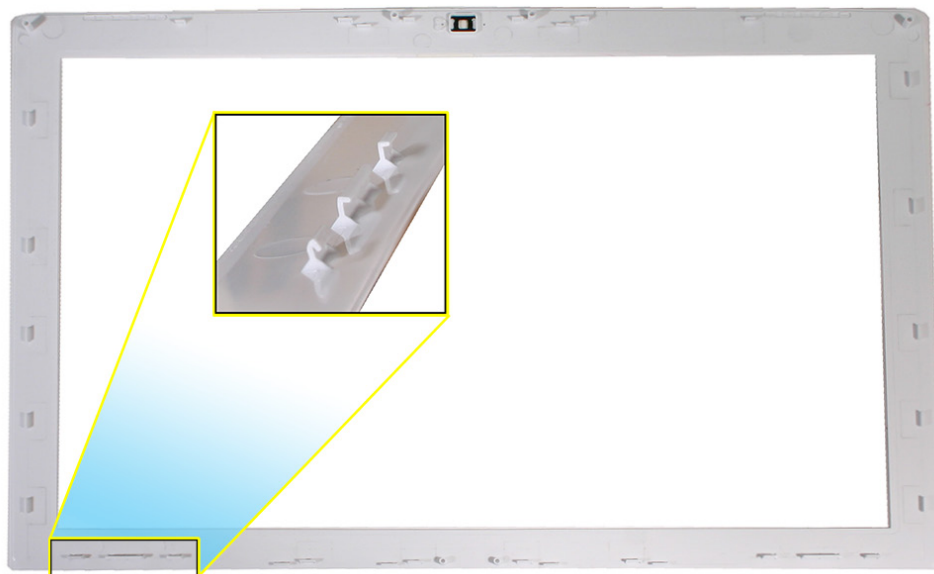

1. **Caution:** To install the bezel, start at the top near the camera first. Match the two locator pins inside the bezel to the holes in the top center of the display assembly.

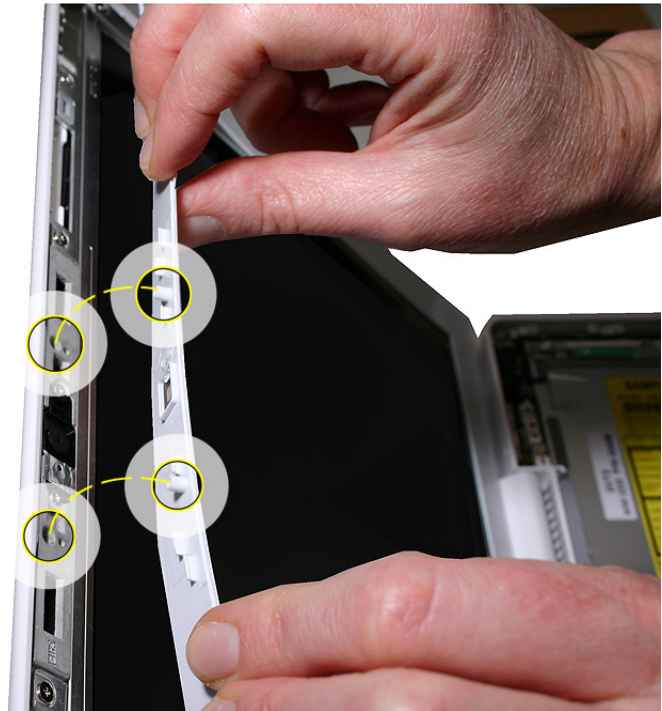

2. Press to secure the top of the bezel.

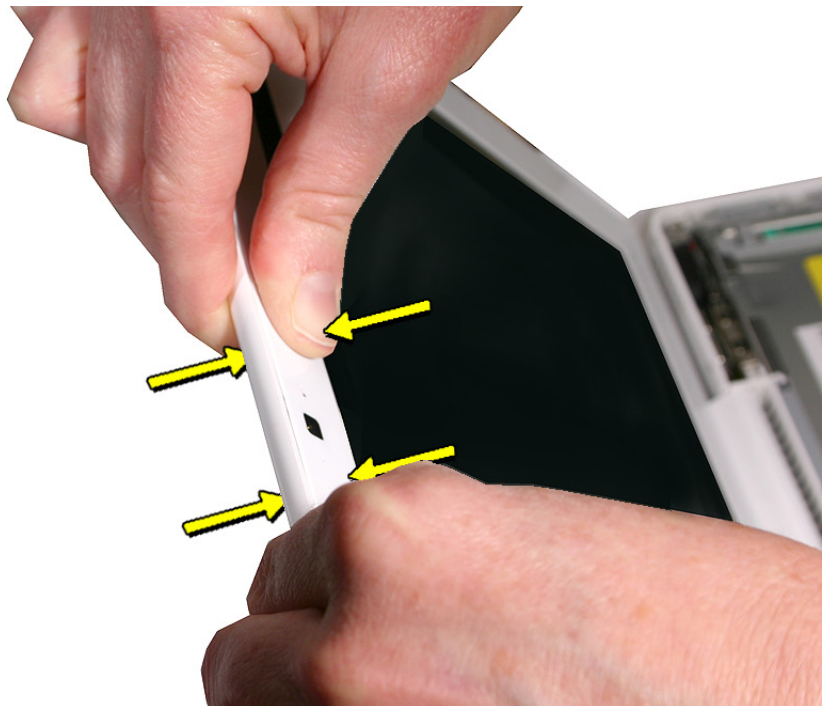

- 
3. With the camera area secured, bend up the bottom of the bezel to hook the bottom edge of the bezel.



4. Press along the outer frame of the bezel to secure it to the display assembly.



# Bezel Mounting Clips

## Tools

- ESD wrist strap and mat
- Clean, soft, lint-free cloth
- Jeweler's flatblade screwdriver

## Preliminary Steps

Before you begin, remove

- [Display bezel](#)

## Part Location

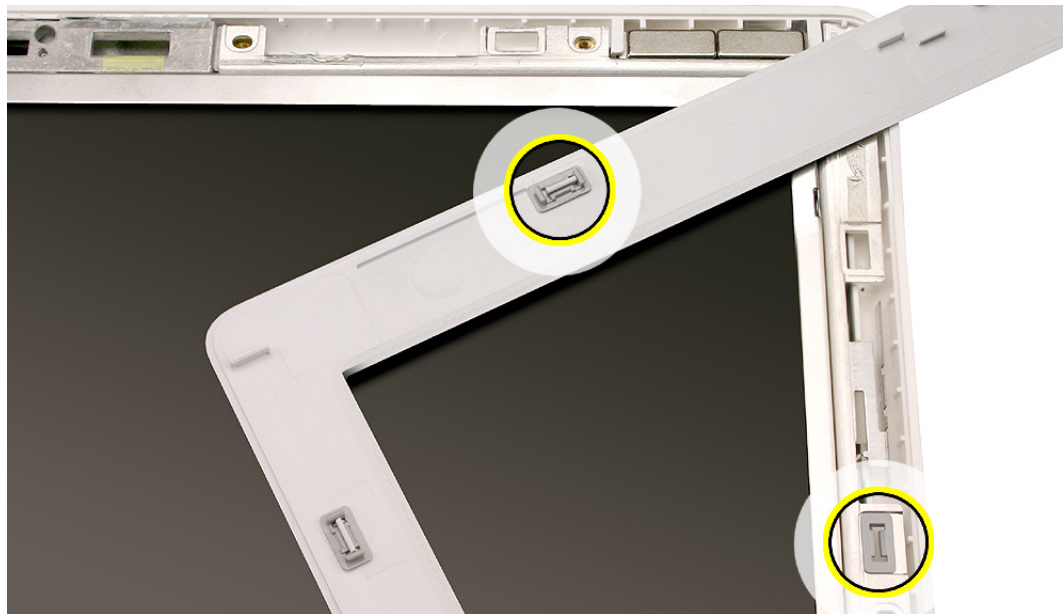

## Removal Procedure

**Caution:** When working near the bezel brace, cover the LCD panel with a soft cloth to avoid scratching the display.

1. Use a jeweler's flatblade screwdriver to pry up the mounting clip.
  - If you are removing the clip from the bezel brace, pry it up from one of the narrow ends.

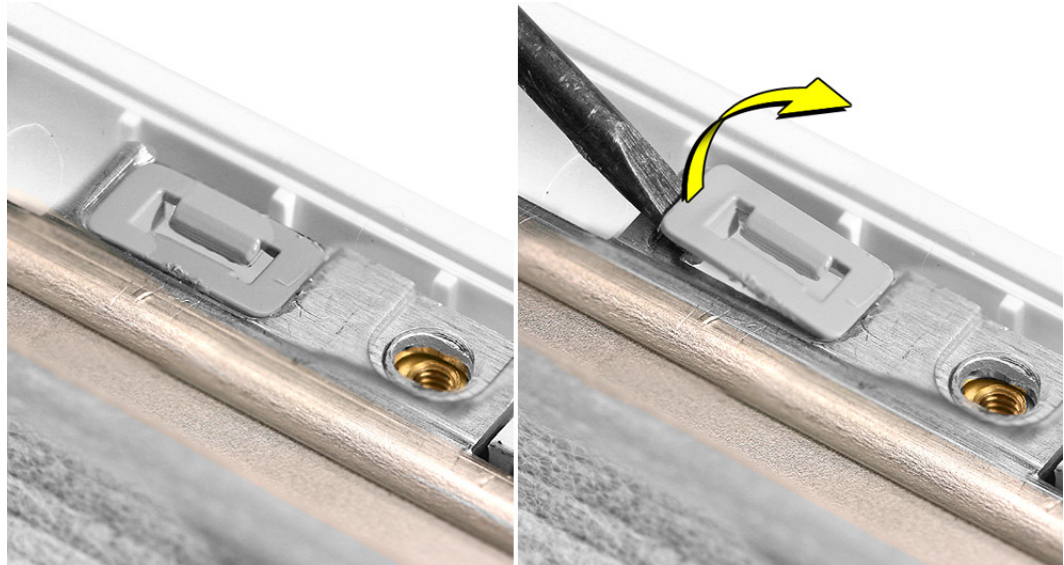

- If you are removing the clip from the display bezel, pry it up from one of the wide sides.

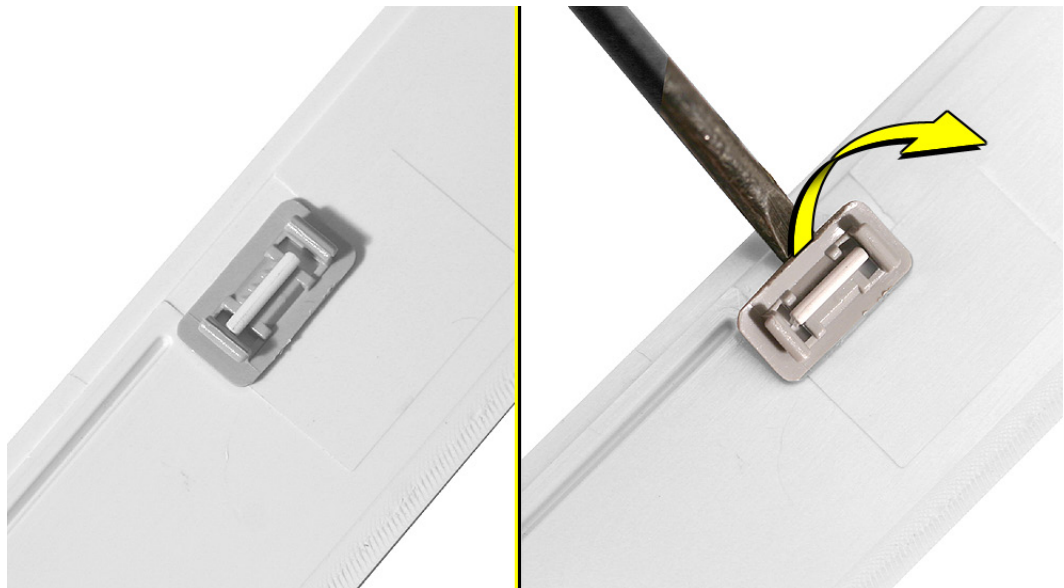

2. Make sure no plastic remnants are left in the bezel brace opening from an old clip. If any small pieces remain, remove them with a needlenose pliers.

---

## Replacement Procedure

1. Closely inspect the two hooks on the replacement mounting clip. Make sure the hooks are intact at a 90-degree angle.

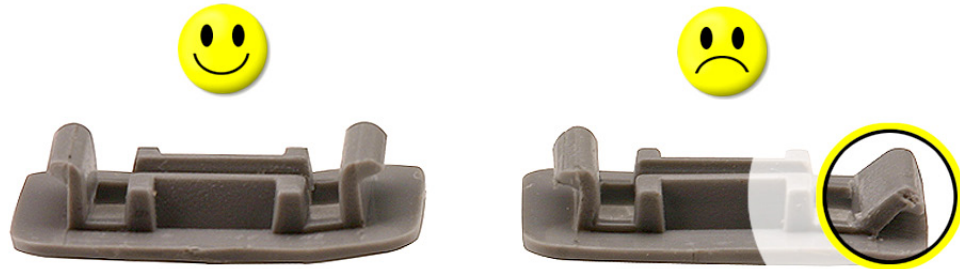

2. Insert one end of the clip so that its hook catches on the bezel brace opening. While holding that end in place, use a jeweler's flatblade screwdriver to tuck in the other hook.  
Note: You might need to bow the clip slightly to get it to fit.

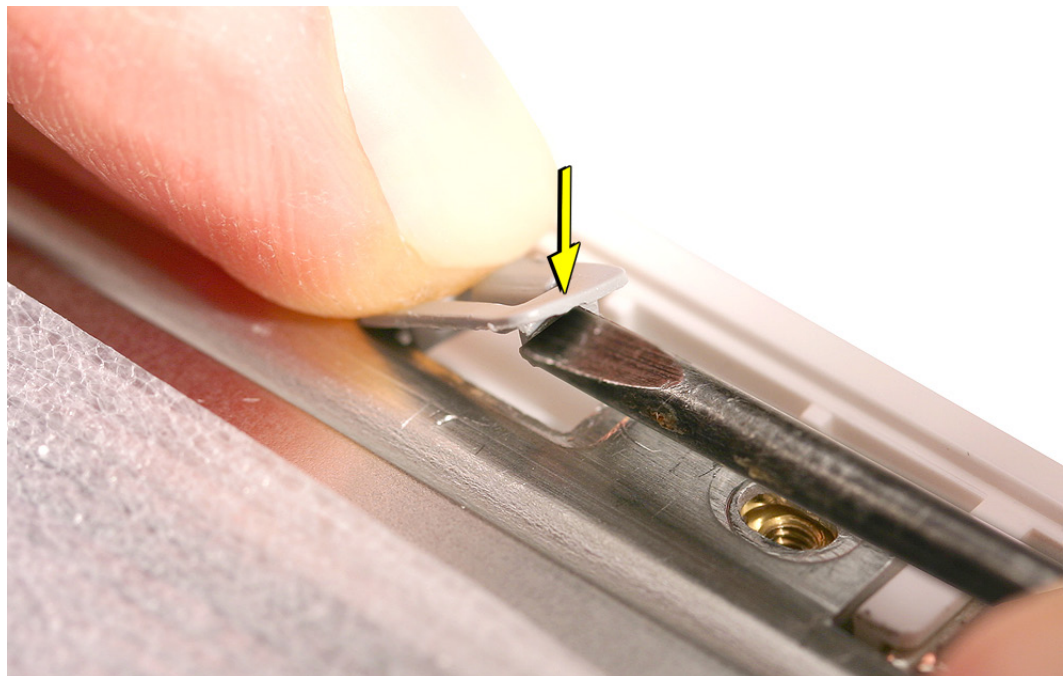

- 
3. Press the clip into place so that it is level with the bezel brace.

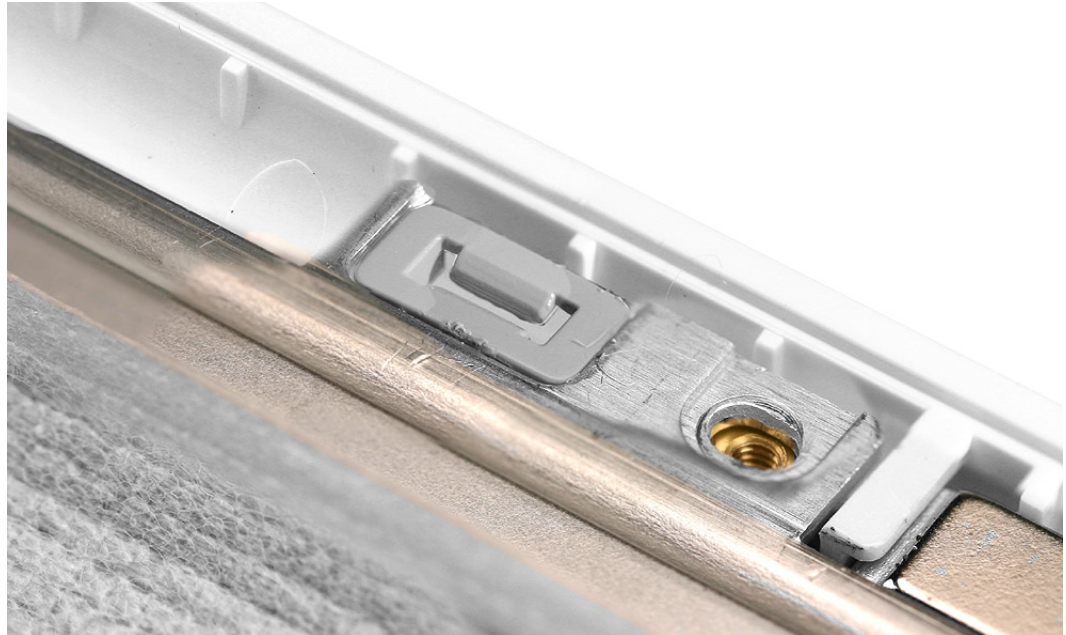

4. Make sure all twelve clips fit correctly in the bezel brace and that no clips remain on the inner side of the display bezel.
5. Install the replacement mounting clips, and reassemble and test the computer.



# Spacers at Bezel Scoops

## Tools

- Soft cloth
- ESD wrist strap and mat
- Black stick (Apple part number 922-5065) or other nonconductive nylon or plastic flatblade tool

## Preliminary Steps

Before you begin, remove

- [Display bezel](#)

## Part Location

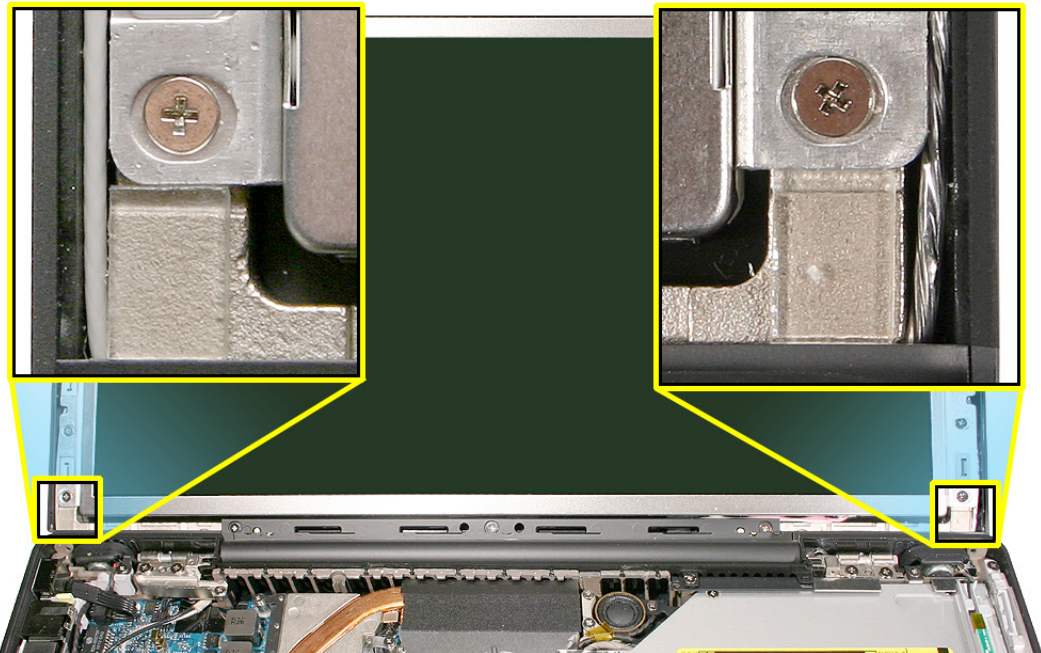

## Procedure

1. Note the placement of the two spacers that attach to the LCD panel frame with double-sided adhesive.

**Replacement Note:** Position the replacement spacers vertically so that they fit into the space between the lower end of the bezel brace and the bezel scoop, but they should not extend past the outer edge of the display hinge.

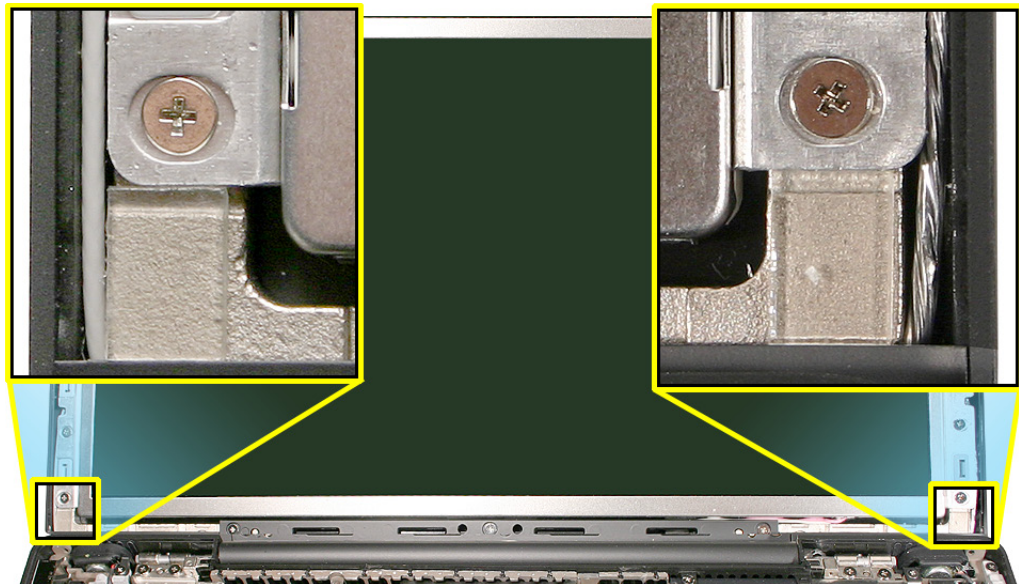

2. Using a black stick, remove the spacers.

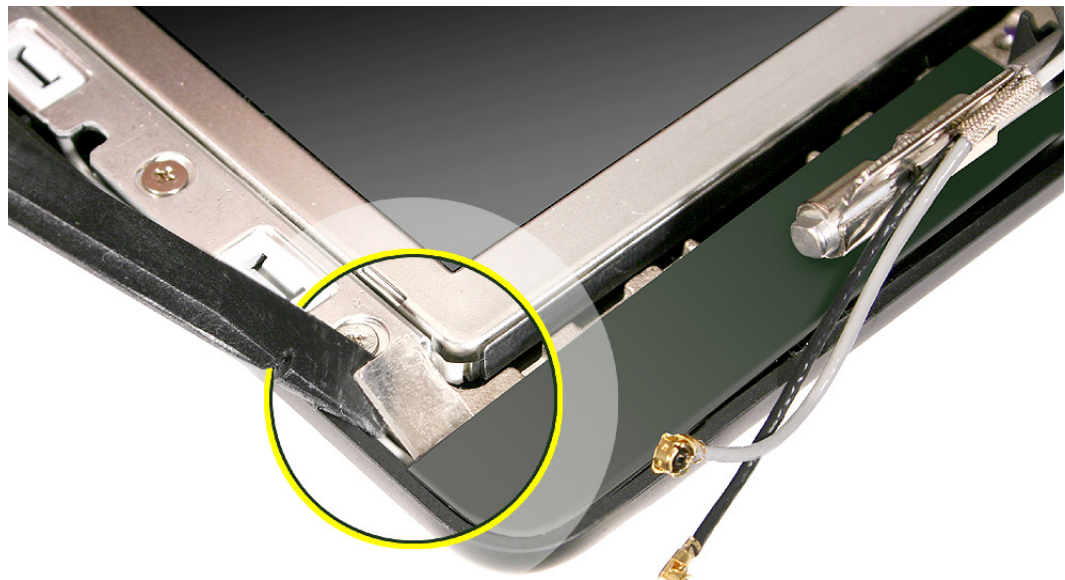

3. Install the replacement spacers above the bezel scoops, and reassemble and test the computer.



# Shims at Display Bezel Scoops

## Tools

- Soft cloth
- ESD wrist strap and mat
- Black stick (Apple part number 922-5065) or other nonconductive nylon or plastic flatblade tool

## Preliminary Steps

Before you begin, remove

- [Display bezel](#)

## Part Location

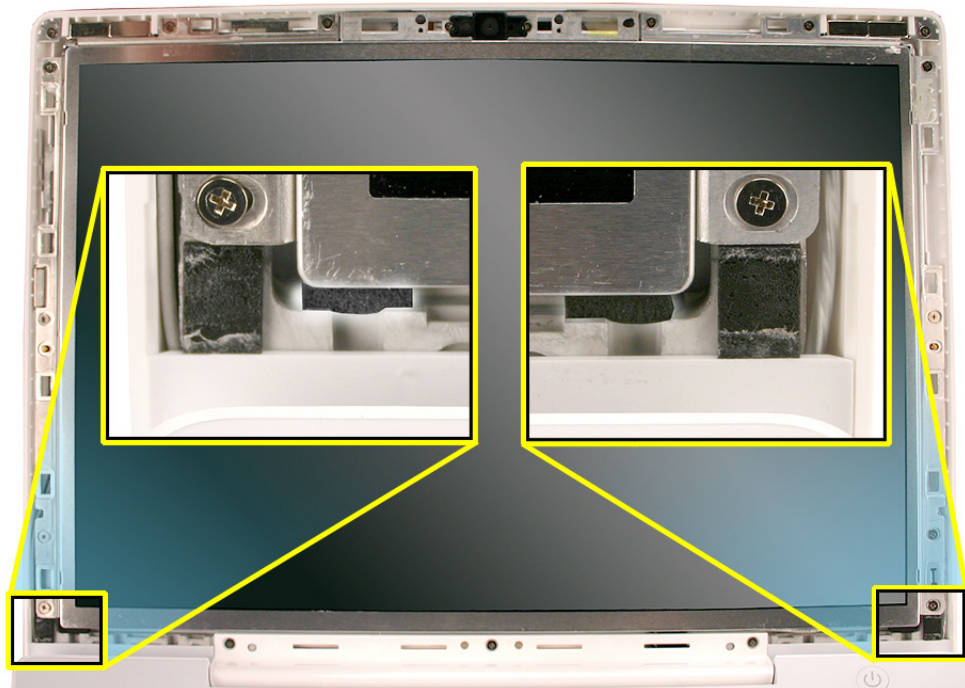

---

## Procedure

1. Note the horizontal placement of the shims that attach to the bottom corners of the LCD panel frame with double-sided adhesive.

**Replacement Note:** Make sure the replacement shims fit into the space between the bottom edge of the LCD panel frame and the slot in the display rear housing.

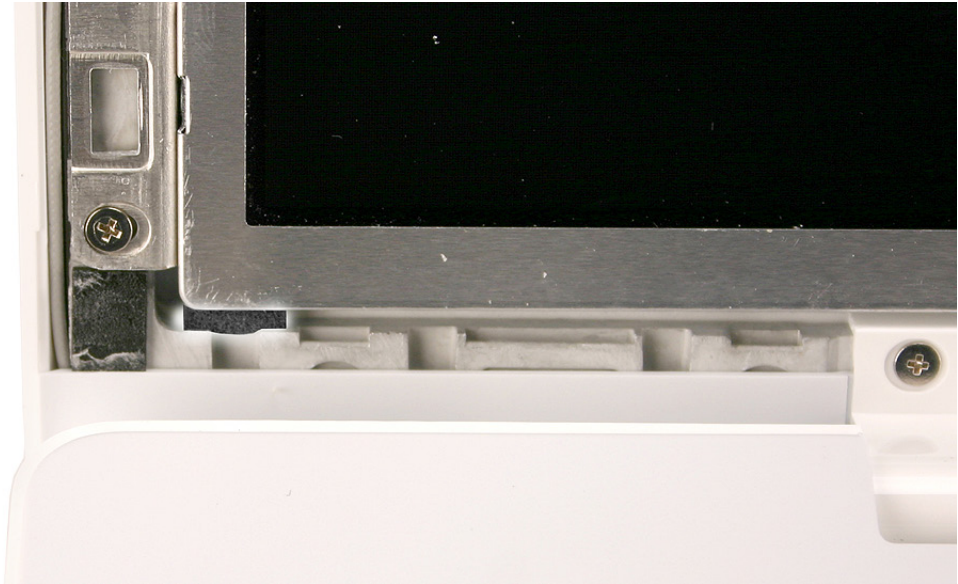

2. Make sure the outer edge of the horizontal shim is approximately 3 mm away from the spacer, and the outer edge of the shim aligns with the outer edge of the LCD panel.

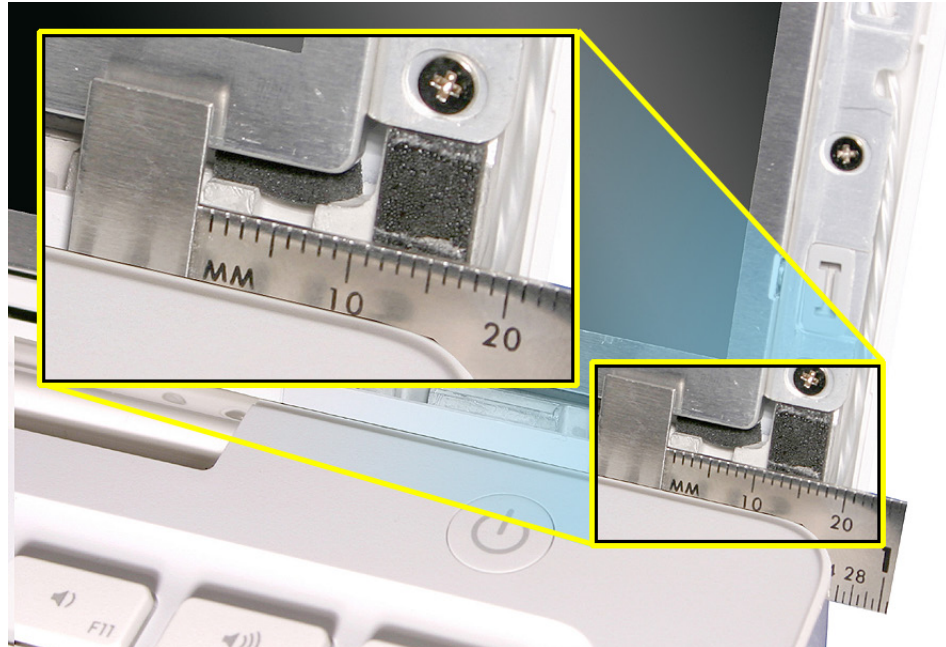

3. Install the replacement shims, and reassemble and test the computer.



## Clutch Block, Left

### Tools

- ESD wrist strap and mat
- Black stick (Apple part no. 922-5065) or other nonconductive nylon or plastic flatblade tool
- Magnetic Phillips #0 screwdriver
- Stack of books, weighted boxes, or other means of support for display while removing screws from hinge

### Preliminary Steps

Before you begin, remove

- [Battery](#)
- [RAM door](#)
- [Top case with keyboard](#)

### Part Location

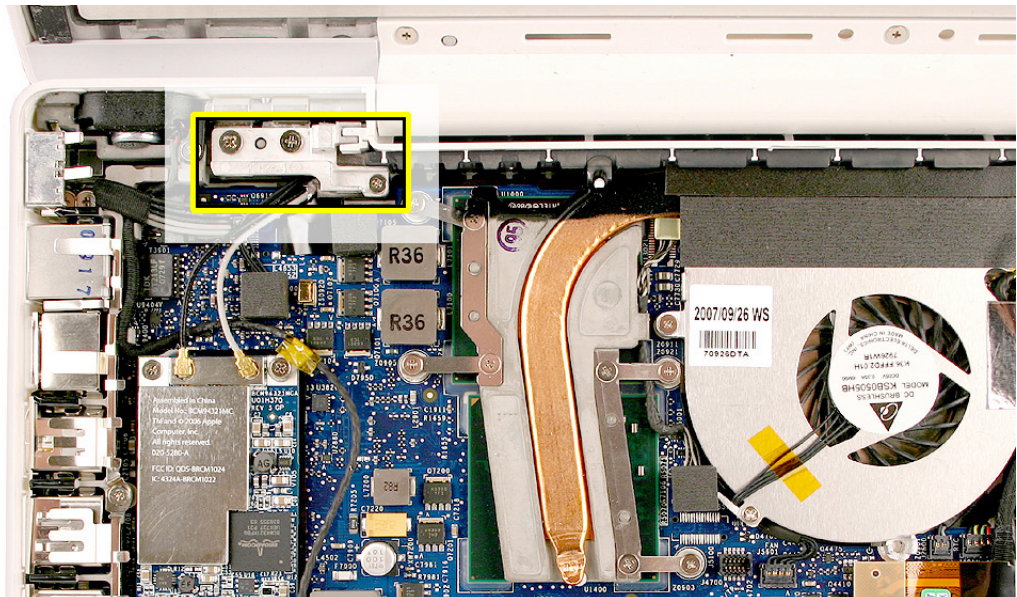

## Procedure

1. Open the display and lean it against a stack of books or boxes that can support it when it is loosened from the display hinge.



2. Remove the screws from the left clutch block:
  - 10-mm long thick-stemmed outer screw, closest to the left corner of the bottom case
  - 6-mm long thick-stemmed middle screw
  - 6-mm long thin-stemmed inner screw, closest to the wireless cables.

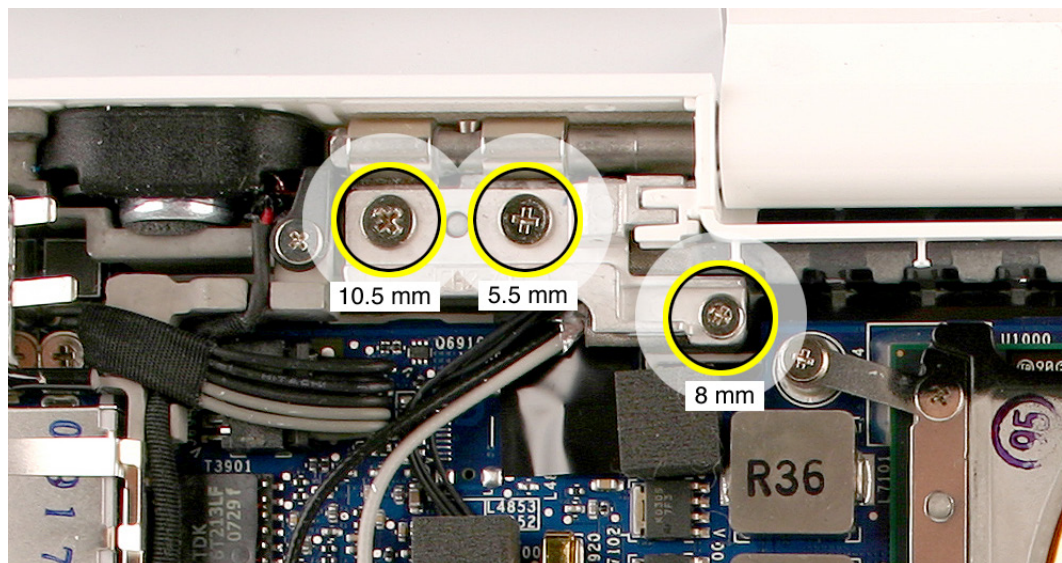

3. Remove the left clutch block from the computer assembly.

**Note:** Although the following image shows some cables disconnected, do not disconnect them.

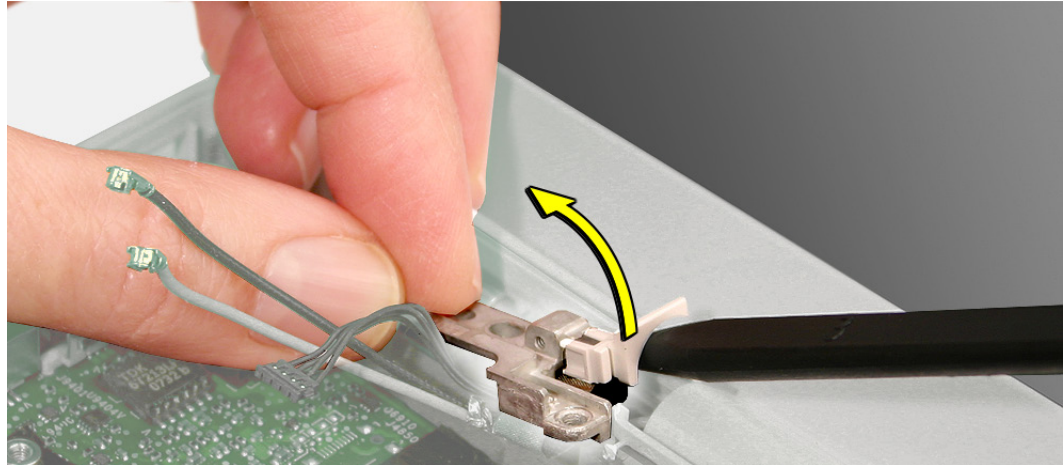

4. Notice that the left clutch cap comes loose when the clutch block is removed. Make sure the left clutch cap is fitted into the clutch block, and hold it in place when replacing the clutch block.

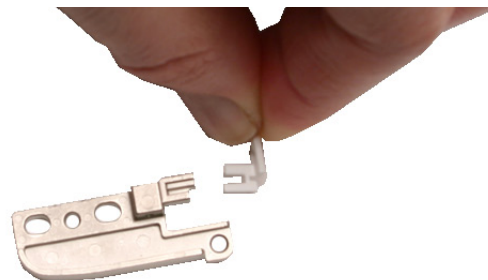

5. If you are installing a new left clutch block, make sure there is a mesh pad on the flip side. This pad protects the cables that run under the left clutch block.

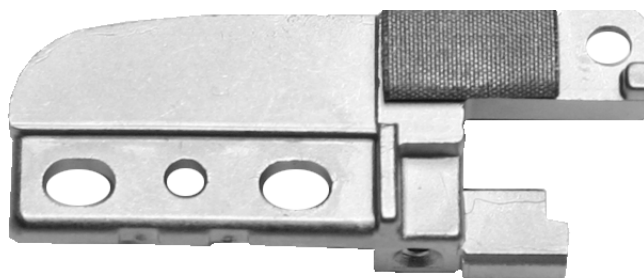

---

**Replacement Note:** Notice how the inverter cable and wireless antenna cables are routed around the left display hinge. Make sure they are routed as shown and cannot be pinched when the clutch cap and clutch block are installed.

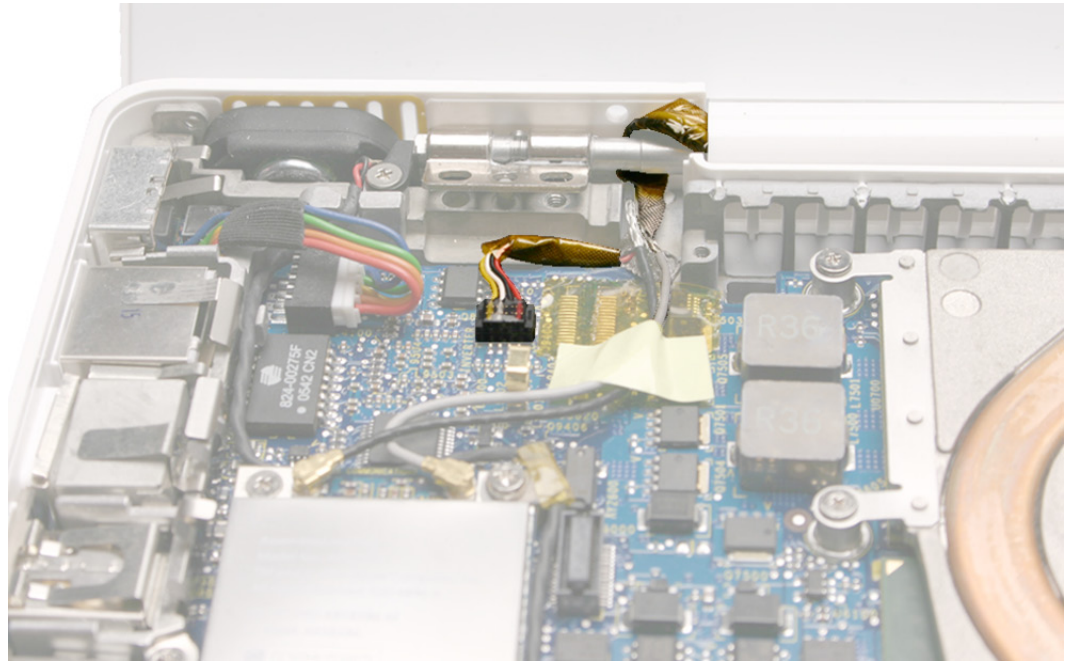

**Replacement Note:** If you are replacing the left and right clutch blocks as a pair, install the screws in an alternating sequence so that the outer screws of each clutch cap are installed first, followed by the remaining screws.

**Replacement Note:** The left clutch cap and right clutch cap are not the same. The left clutch cap is pictured below.





## Clutch Block, Right

### Tools

- ESD wrist strap and mat
- Black stick (Apple part no. 922-5065) or other nonconductive nylon or plastic flatblade tool
- Magnetic Phillips #0 screwdriver
- Stack of books (or other means of support for the display while removing screws from the display hinge)

### Preliminary Steps

Before you begin, remove

- [Battery](#)
- [RAM door](#)
- [Top case with keyboard](#)
- [Optical drive](#)

### Part Location

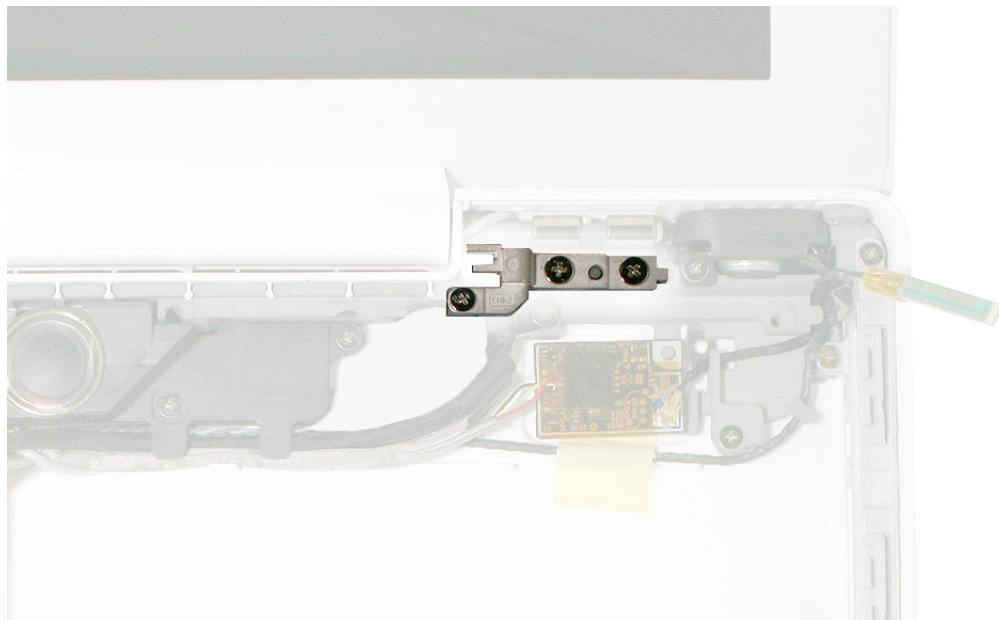

## Procedure

**Important Note:** The photography below may differ from the actual unit you are repairing; however, the actual procedure remains the same.

1. Remove the screws from the right clutch block:
  - 10-mm long thick-stemmed outer screw, closest to the right corner of the bottom case
  - 6-mm long thick-stemmed middle screw
  - 3-mm long thin-stemmed inner screw

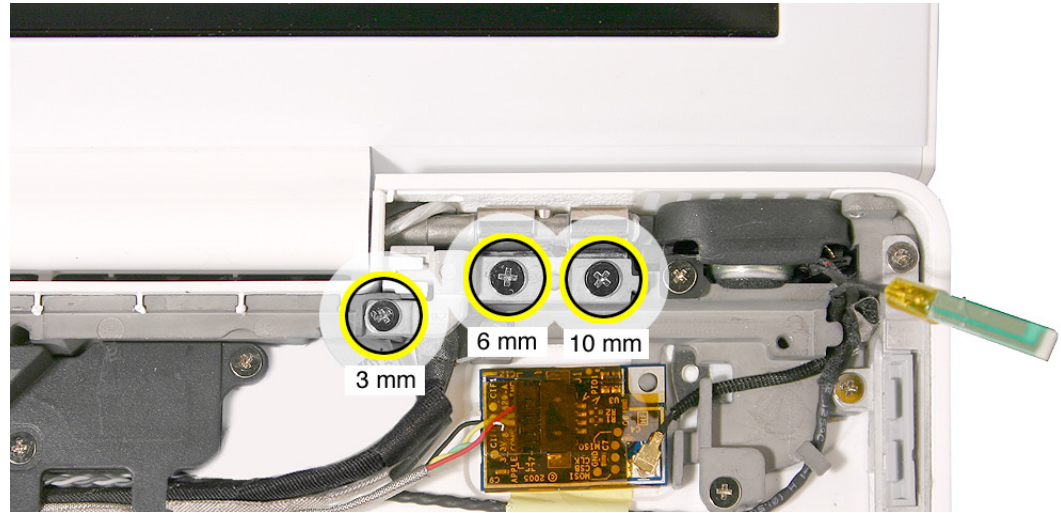

2. Use a black stick or finger to remove the right clutch block from the computer assembly.

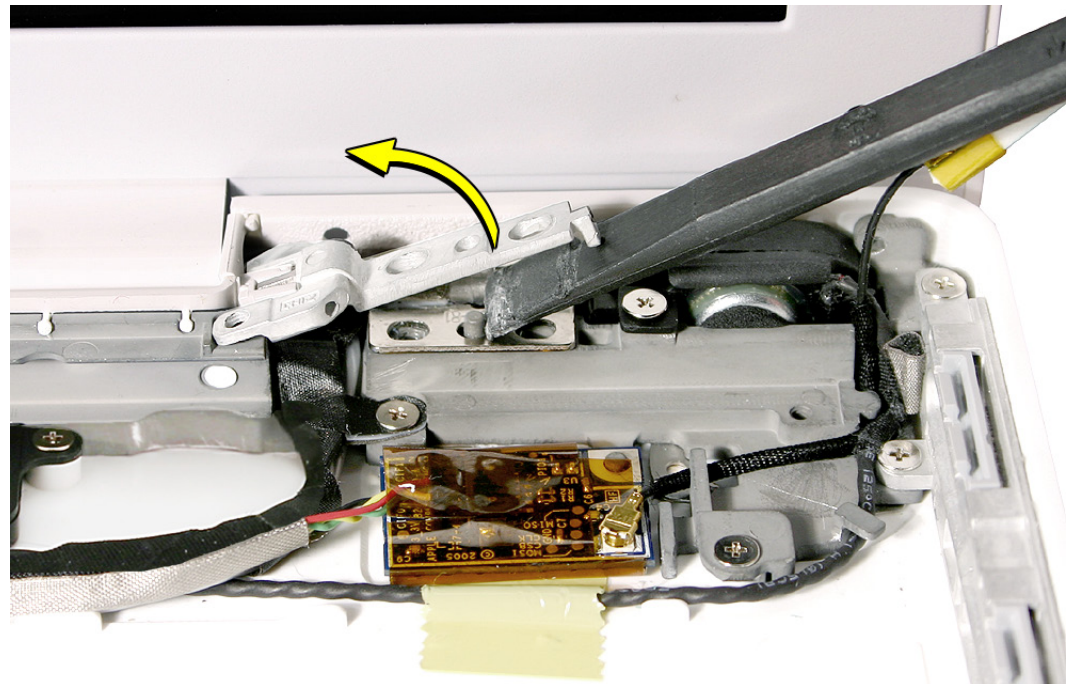

---

**Replacement Note:** Tilt the left end of the right clutch block into the rear panel first so that the clutch cap engages with the bottom case. Then make sure the screw holes are aligned properly before installing the screws.

**Note:** Unlike the left clutch block, there is no mesh pad on the right clutch block.

**Replacement Note:** Notice how the right clutch cap comes loose as soon as the clutch block is removed. Make sure the right clutch cap is fitted into the clutch block, and hold it in place before installing the screws.



**Replacement Note:** Notice how the LVDS cable and microphone cable are routed around the right display hinge. Make sure they are routed as shown and cannot be pinched when the right clutch block and clutch cap are installed.

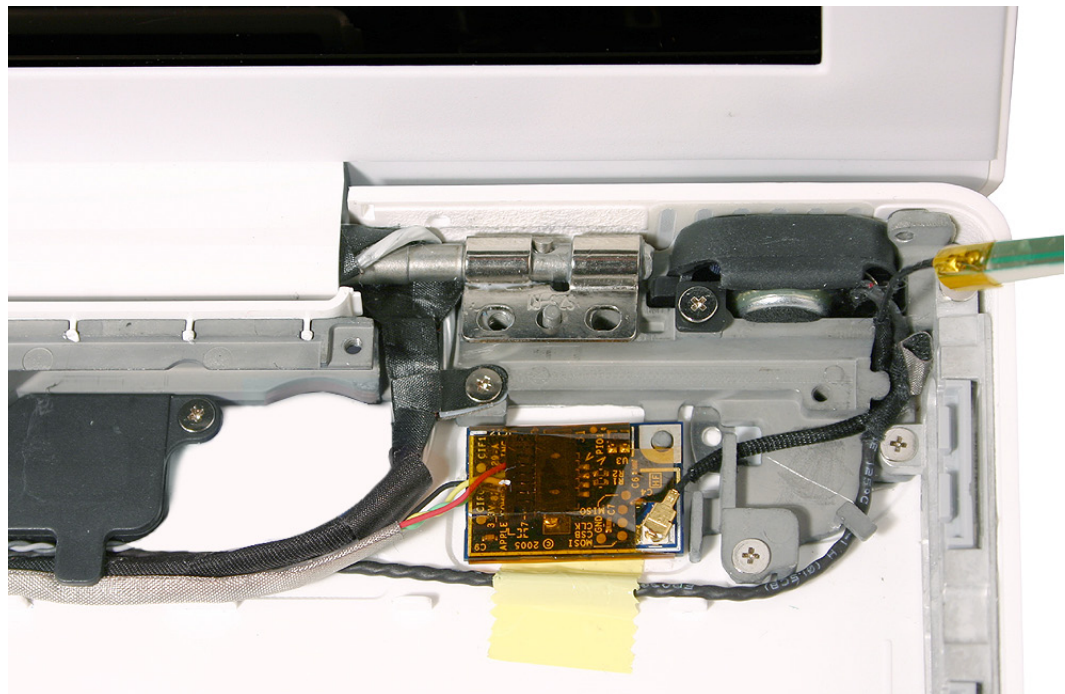

---

**Replacement Note:** If you are replacing the left and right clutch blocks as a pair, install the screws in an alternating sequence so that the outer screws of each clutch cap are installed first, followed by the remaining screws.

**Replacement Note:** The right clutch cap and left clutch cap are not the same. The right clutch cap is pictured below.





## Clutch Caps

**(Refer to “Clutch Block, Left” and “Clutch Block, Right”)**



# Display Module

Note: Although the display module is not offered as an available part, removing it is required to access all internal display parts (except the bezel).

## Tools

- ESD wrist strap and mat
- Black stick (Apple part no. 922-5065) or other nonconductive nylon or plastic flatblade tool
- Magnetic Phillips #0 screwdriver
- Stack of books, weighted boxes, or other means of support for display while removing screws from hinge

## Preliminary Steps

Before you begin, remove

- [Battery](#)
- [RAM door](#)
- [Top case with keyboard](#)
- [Optical drive](#)
- [Clutch block, left](#)
- [Clutch block, right](#)

## Part Location



## Procedure

1. From the logic board, disconnect the following connectors:
  - Two wireless card antenna cables
  - Microphone cable (located between I/O shield and left memory slot)
  - LVDS cable

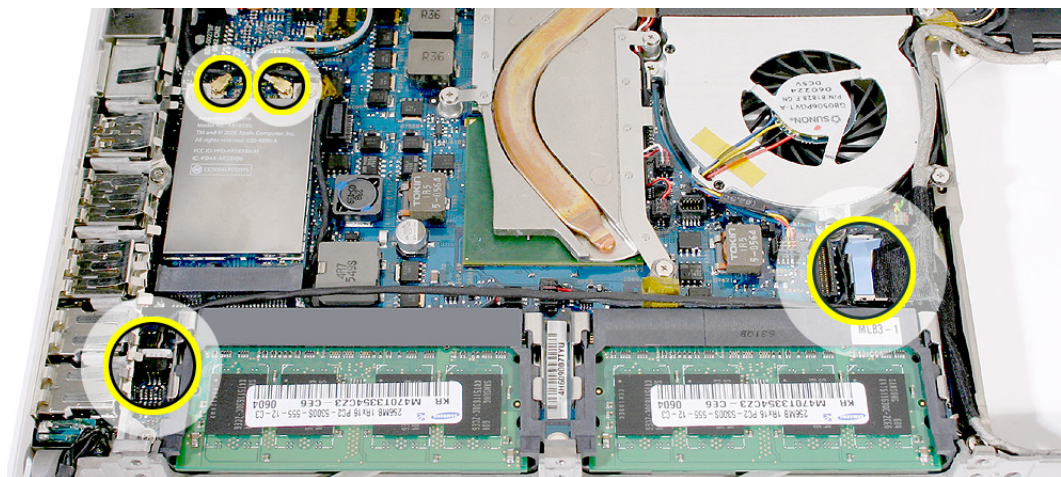

2. Remove the 3-mm ground screw that secures the cables to the midframe.



**Warning:** The subwoofer cone is a sensitive device. Avoid touching the subwoofer cone.

3. Carefully unroute the LVDS cable and microphone cable from under the subwoofer tabs in the bottom case.

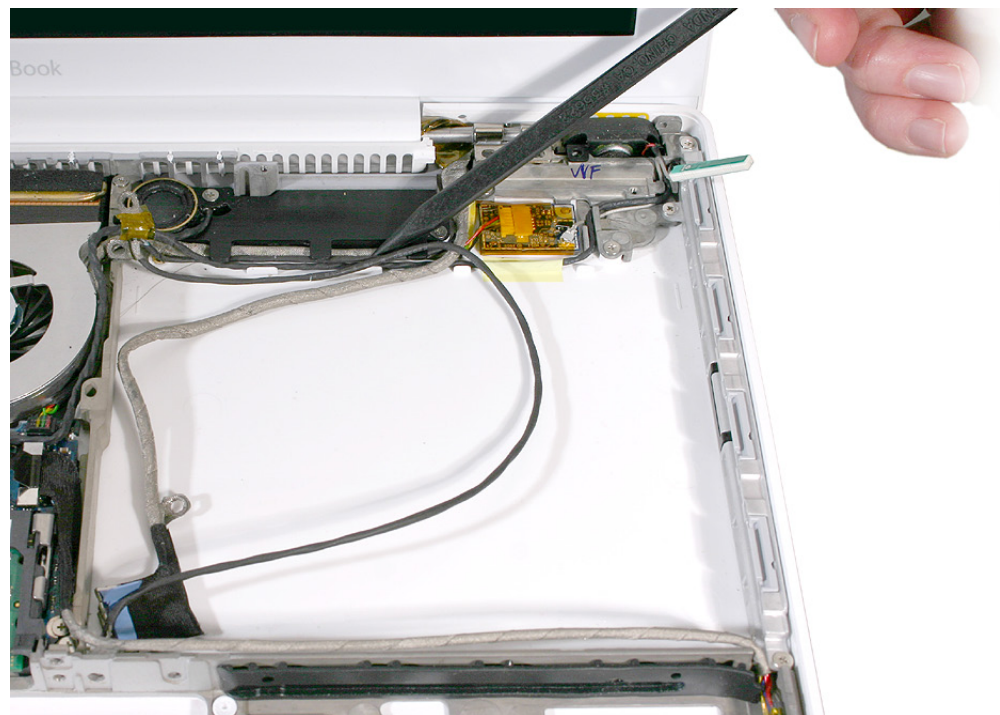

4. Near the right hinge, remove the 3-mm long ground screw that anchors the LVDS cable to the upper right corner of the bottom case.

**Note:** The photography below may differ from the actual unit you are repairing; however, the actual procedure remains the same.

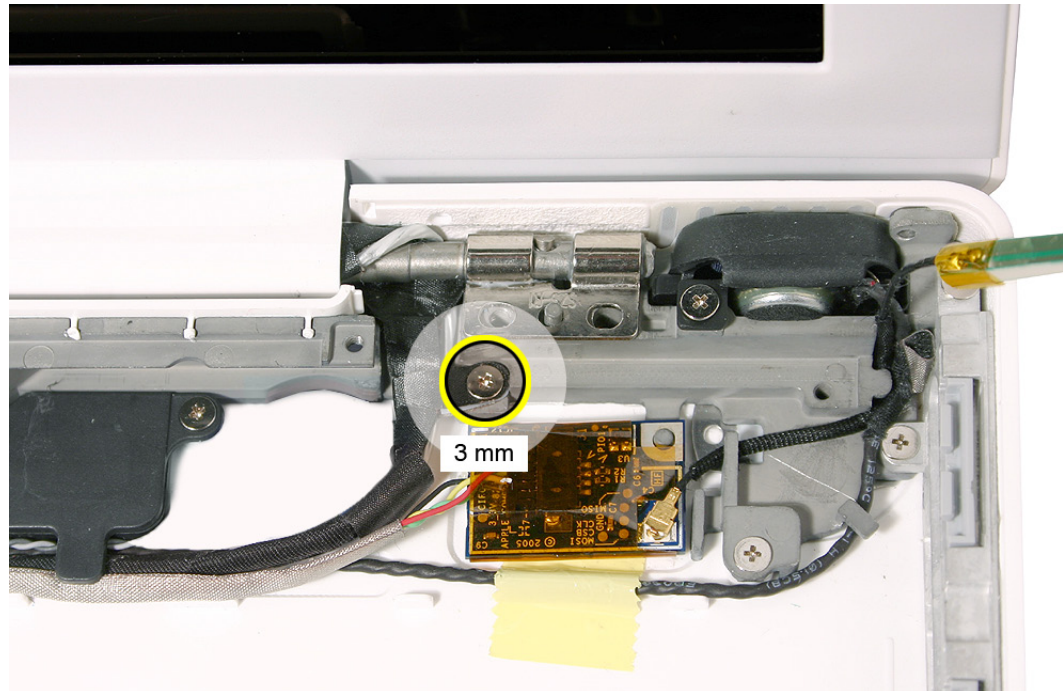

5. Near the left hinge, disconnect the inverter cable.

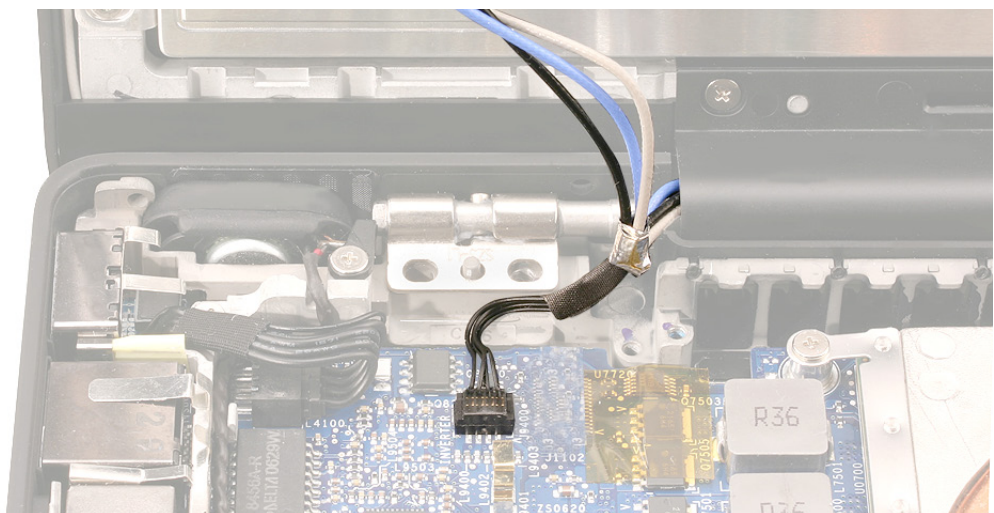

- 
6. Holding the display module at the bezel, lift the module off of the computer assembly.



7. Install the replacement display module, and reassemble and test the computer.

**Replacement Note:** When installing the display, note how the cables are routed at the right side of the clutch barrel—the LVDS cable and microphone cable wrap around the back of the clutch barrel and are routed into the bottom case.

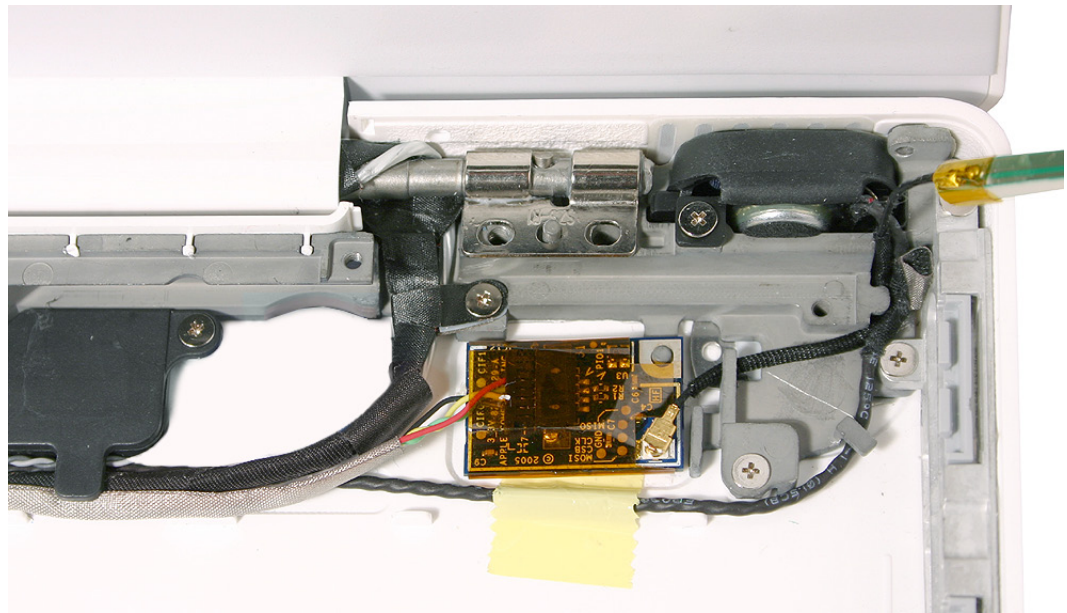

**Replacement Note:** The microphone cable routes under the LVDS cable.



**Replacement Note:** Make sure that no cables can be pinched when installing the LVDS cable ground screw.

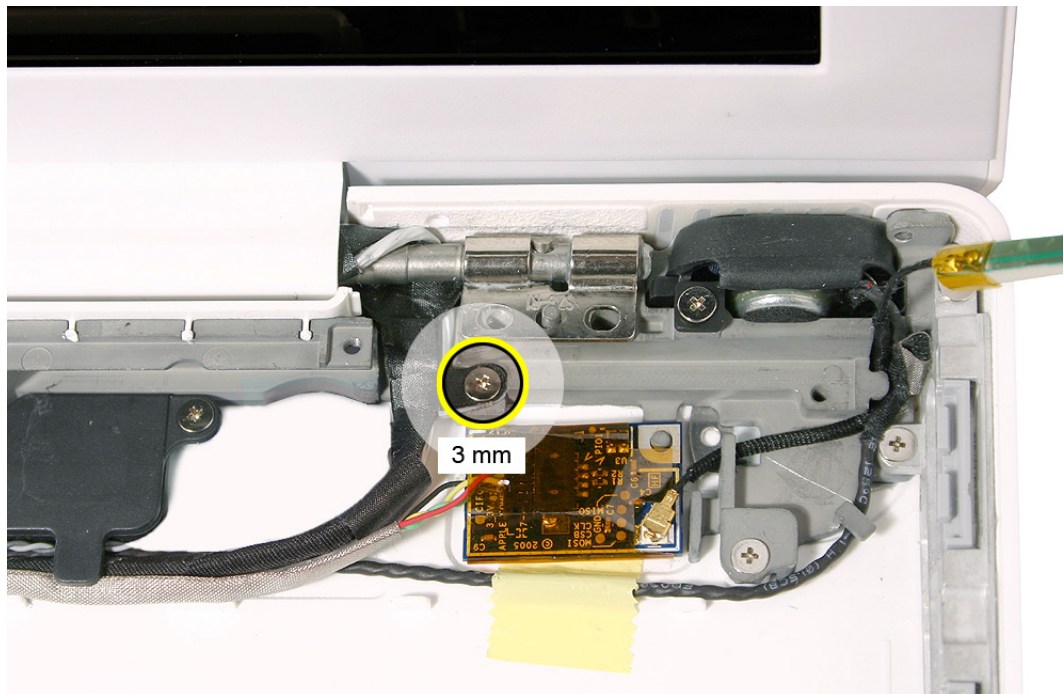



## Bottom Case

**Note:** The bottom case includes the following parts:

- Feet that are heat-staked, so they are not removable
- Three integral frames: slot-load bezel frame, front bay frame, and rear frame
- Infrared (IR) sensor board in the front right corner
- Snubbers for hard drive

### Tools

- Soft cloth
- ESD wrist strap and mat
- Magnetic Phillips #0 screwdriver
- Black stick (Apple part no. 922-5065) or other nonconductive nylon or plastic flatblade tool

### Preliminary Steps

Before you begin, remove

- [Battery](#)
- [RAM door](#)
- [Hard drive](#)
- [Top case with keyboard](#)
- [AirPort card](#)
- [MagSafe DC-in board](#)
- [Left speaker](#)
- [I/O frame](#)
- [Battery connector with sleep switch](#)
- [Fan](#)
- [Heatsink](#)
- [Optical drive](#)
- [Bluetooth antenna](#)
- [Bluetooth board](#)
- [Bluetooth-to-logic board cable](#)
- [Subwoofer with right speaker](#)
- [Midframe](#)
- [Logic board](#)
- [Clutch blocks, left and right](#)
- [Display module](#)

---

## Part Location

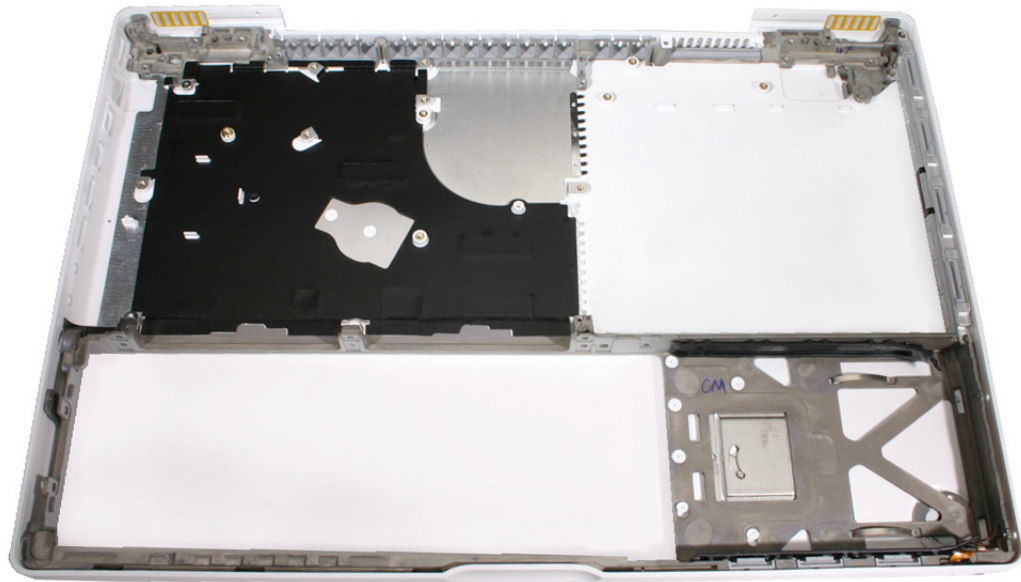

## Procedure

When the parts listed in the “Preliminary Steps” have been removed, the remaining part is the bottom case.

**Replacement Note:** Make sure the bottom case is clean and free of dust before assembling the computer.

**Important:** Make sure that the mushroom-shaped rubber standoff is in place where shown before installing the logic board.

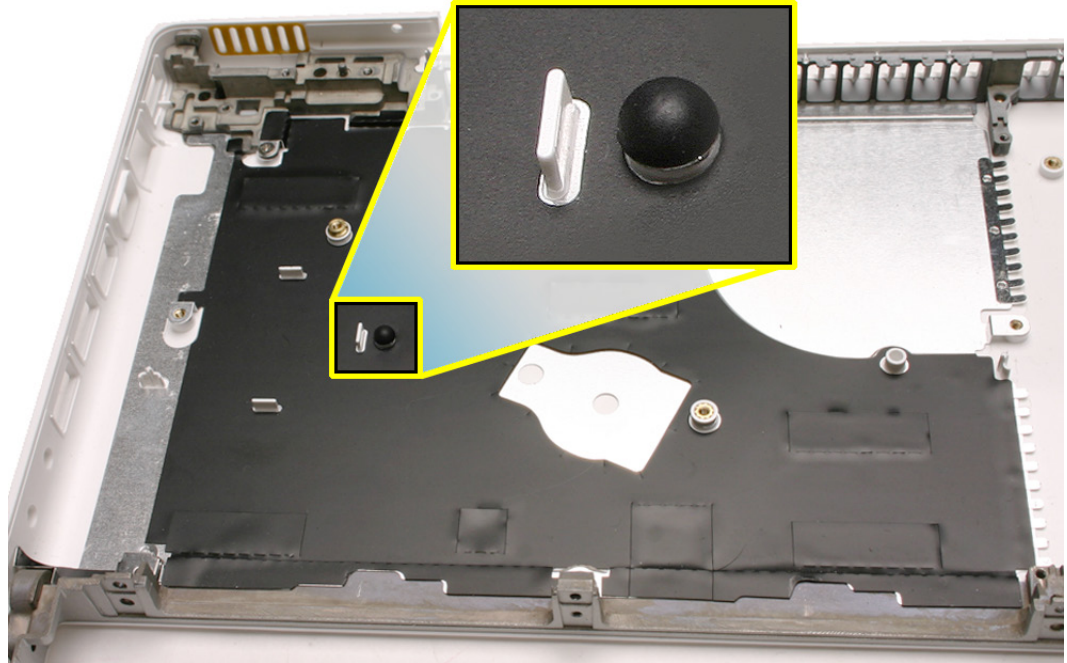

Note: If the rubber standoff comes loose, use needlenose pliers to install it.

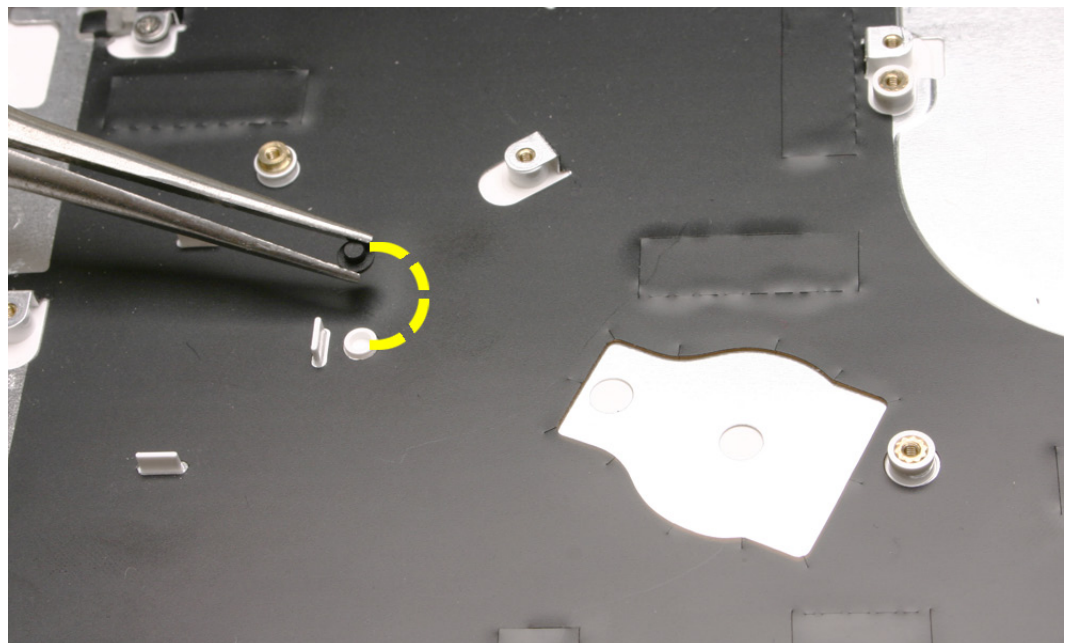



# Clutch Cover

## Tools

- ESD wrist strap and mat
- Magnetic Phillips #0 screwdriver
- Black stick (Apple probe tool, part no. 922-5065) or other nonconductive nylon or plastic flatblade tool
- Access card (Apple part number 922-7172)

## Preliminary Steps

Before you begin, remove

- [Battery](#)
- [RAM door](#)
- [Top case with keyboard](#)
- [Optical drive](#)
- [Clutch block, left](#)
- [Clutch block, right](#)
- [Display module](#)
- [Display bezel](#)

---

## Part Location



## Procedure

**Important:** The display cables might catch on the clutch cover as you remove it, so proceed slowly to prevent any cable damage.

1. Notice the cable exits points at each side of the clutch. Refer to the cable arrangement shown when reinstalling the clutch cover.

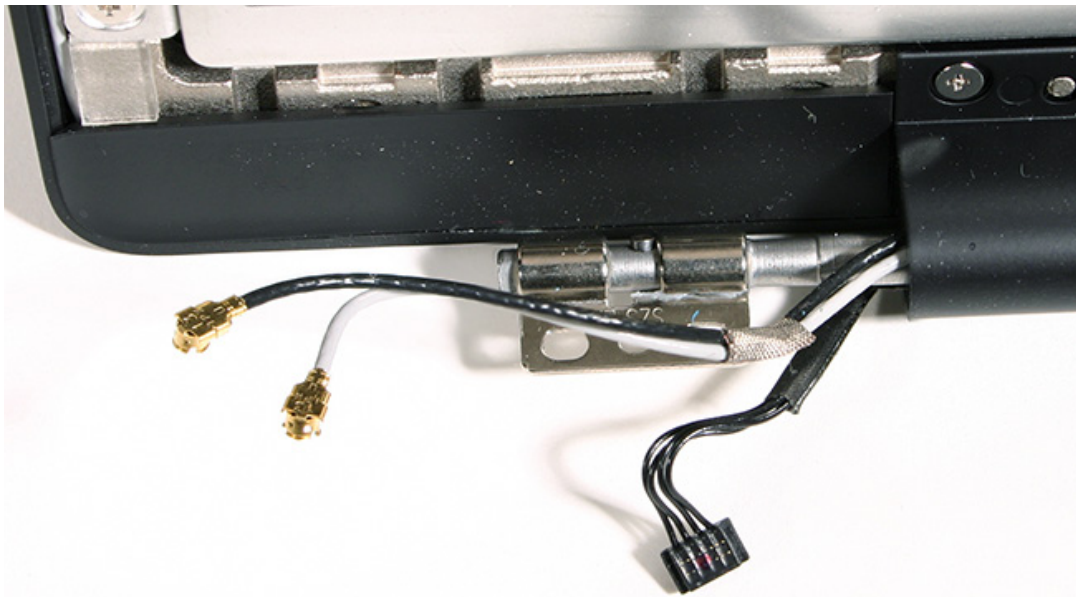

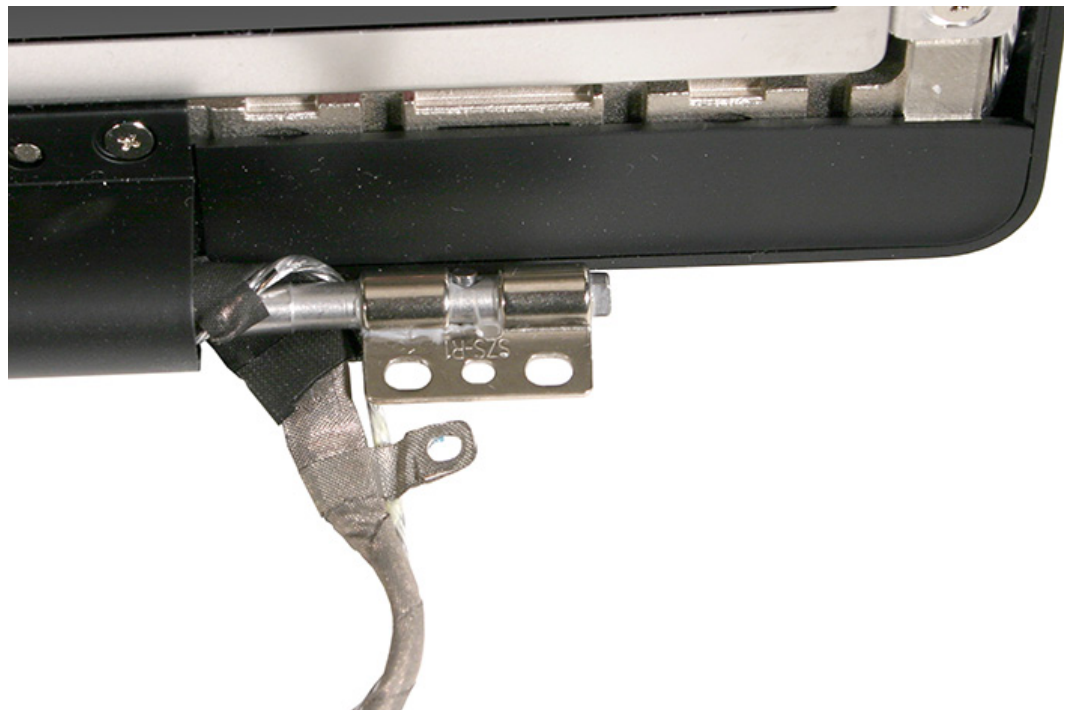

2. With the display assembly face up, remove the three 4-mm long screws along the top edge of the clutch cover.

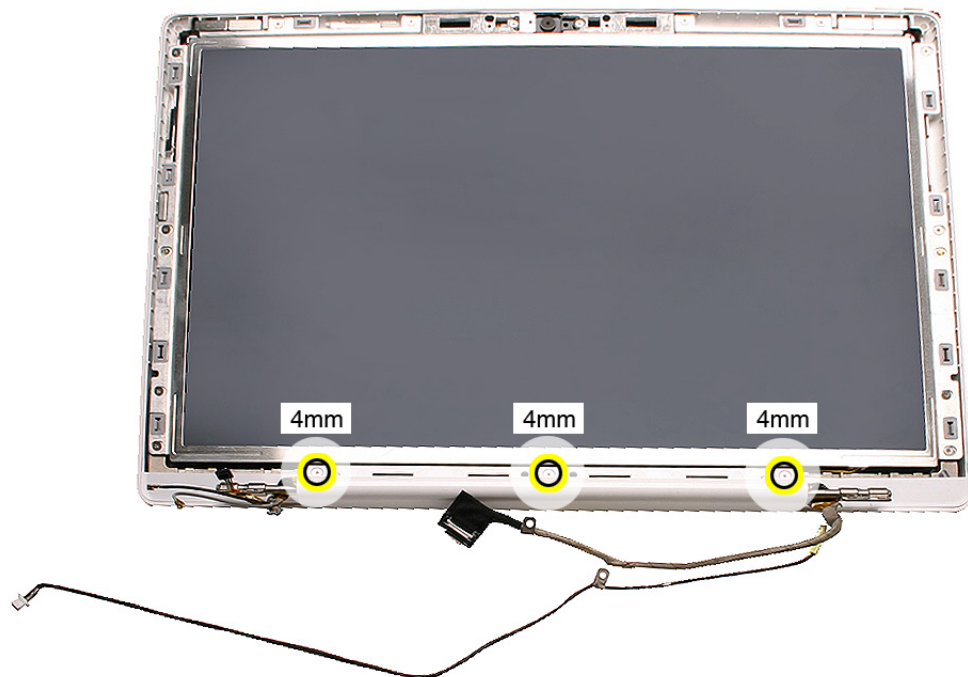

- 
- Slide an access card along the outer edge of the clutch cover to loosen it from the display rear housing.



- Unsnap both ends of the clutch cover using a black stick.

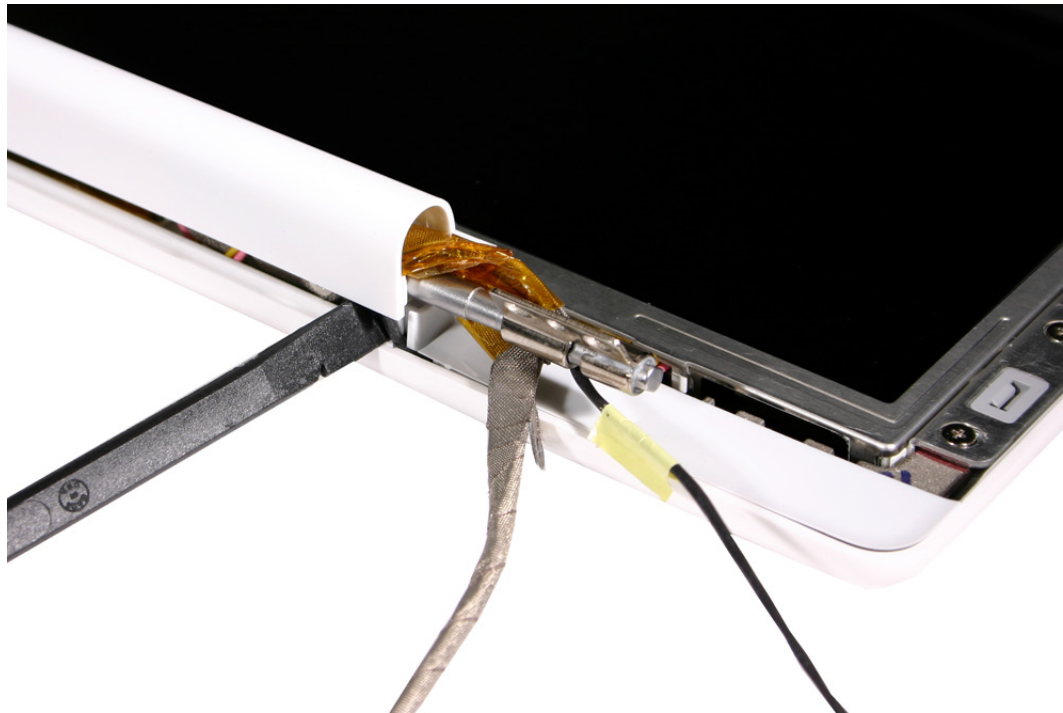

5. Holding the bundled display cables at each end of the clutch cover, carefully unwrap them to help raise up the clutch cover.



6. Without straining cables, carefully pull the clutch cover off of the display assembly.

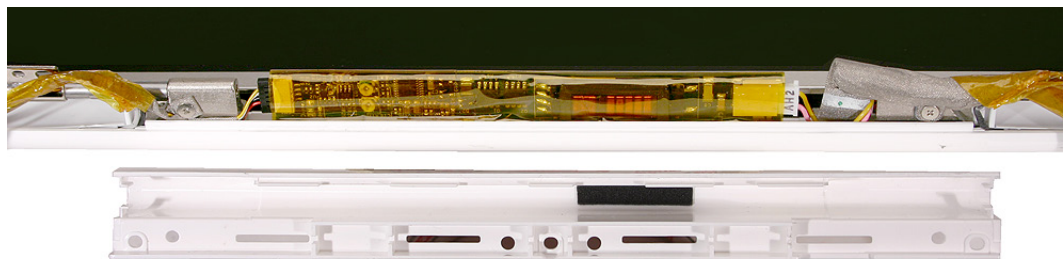

7. Install the replacement clutch cover, and reassemble and test the computer.



**Replacement Note:** The inner channel of the clutch cover includes a foam pad that helps stabilize the inverter board. Do not remove it.

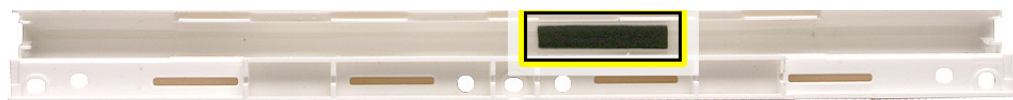

---

**Replacement Note:** Be careful when securing the snaps at each end of the clutch cover. Cables wrap around the barrel at the hinges, but tucking in the cables just right is difficult, and the cables are subject to pinching damage when the clutch cover is installed.

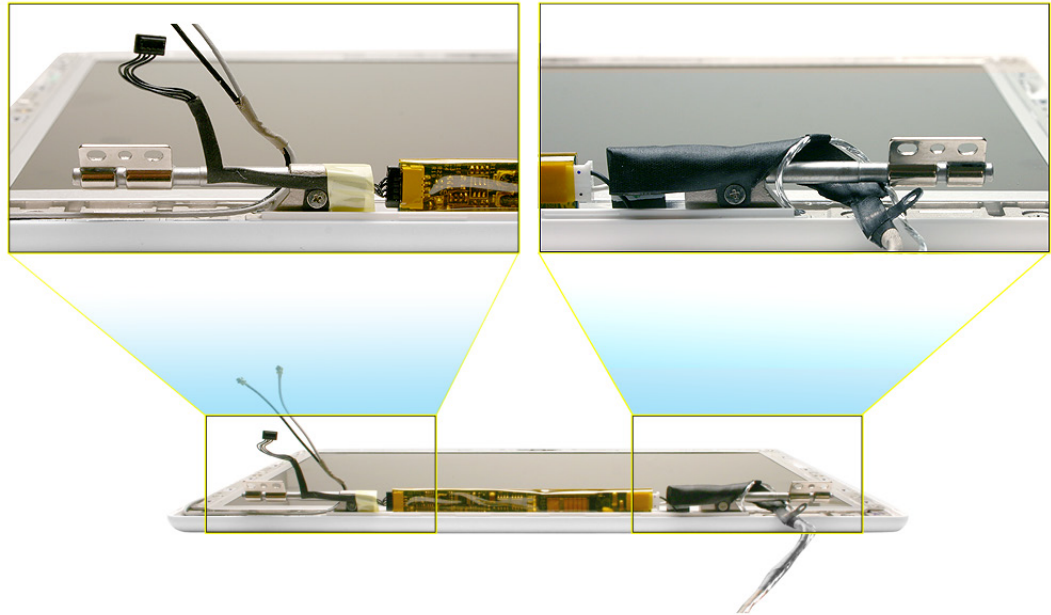

**Replacement Caution:** Notice how the display cables are wrapped around the clutch. Check that they are wrapped as shown before reassembling the computer.

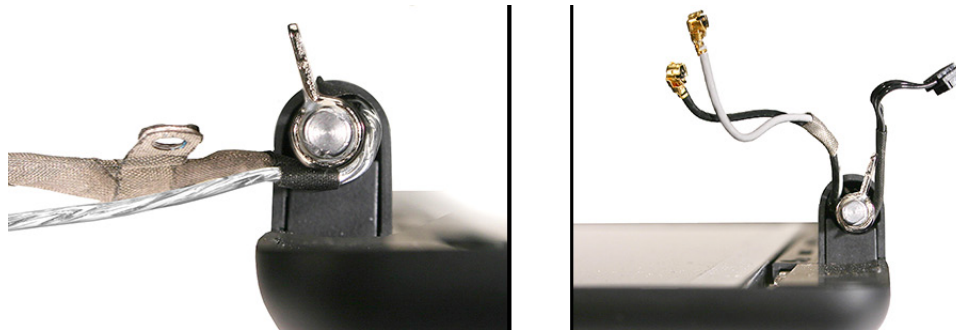



# Bezel Scoops, Left and Right

## Tools

- ESD wrist strap and mat
- Black stick (Apple probe tool, part no. 922-5065) or other nonconductive nylon or plastic flatblade tool

## Preliminary Steps

Before you begin, remove

- [Battery](#)
- [RAM door](#)
- [Top case with keyboard](#)
- [Optical drive](#)
- [Display module](#)
- [Display bezel](#)
- [Clutch cover](#)
- [Spacers at bezel scoops](#)

## Part Location



---

## Procedure

1. With the bezel spacers removed, use a black stick to loosen the outer edge of the bezel scoop and push it toward the display face. Repeat for the other bezel scoop.



**Replacement Note:** Before replacing the bezel scoops, make sure that the cables that are routed under the bezel scoops have no slack. Refer to the following images for the correct cable routing.





**Replacement Note:** On the underside of each bezel scoop, note that the three raised tabs match up with the three slots in the display hinge. Align the tabs to the slots.

**Replacement Note:** With the cables tucked in, slide on the bezel scoop.

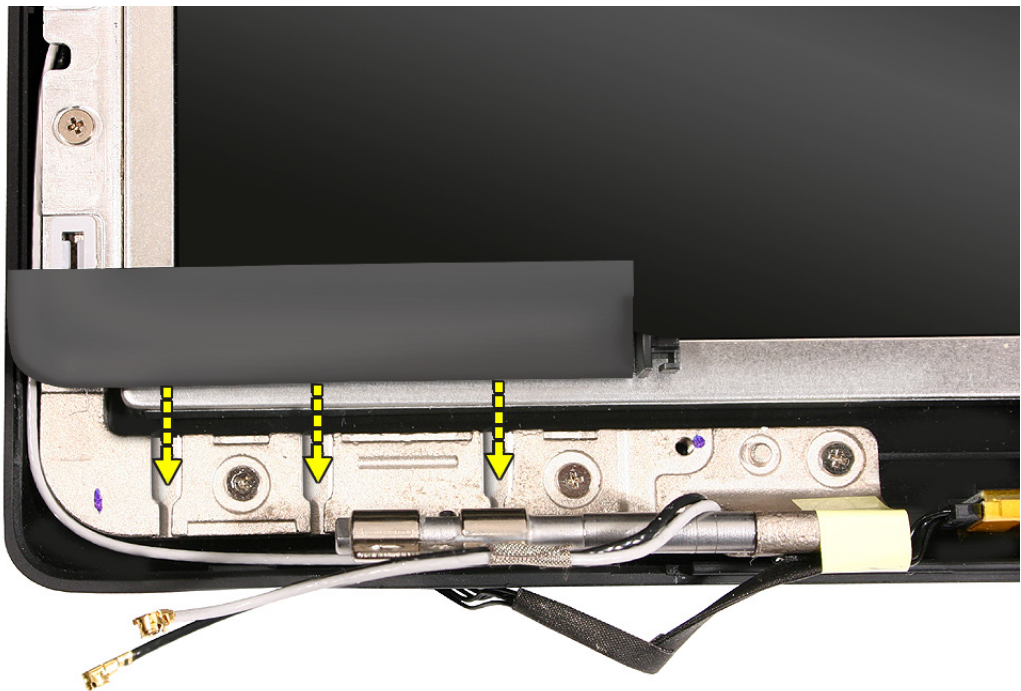



# LCD Panel

## Tools

- Soft cloth
- ESD wrist strap and mat
- Magnetic Phillips #0 screwdriver
- Black stick (Apple part no. 922-5065) or other nonconductive nylon or plastic flatblade tool
- Flashlight or bright lamp

## Preliminary Steps

Before you begin, remove

- [Battery](#)
- [RAM door](#)
- [Top case with keyboard](#)
- [Optical drive](#)
- [Clutch block, left](#)
- [Clutch block, right](#)
- [Display module](#)
- [Display bezel](#)
- [Clutch cover](#)
- [Spacers at bezel scoops](#)
- [Bezel scoops](#)
- [Inverter board](#)
- [LCD panel assembly](#)
- [LVDS cable](#)
- [Bezel brace, left, with attached cables](#)
- [Bezel brace, right, with attached cables](#)
- [Camera assembly](#)

---

## Part Location

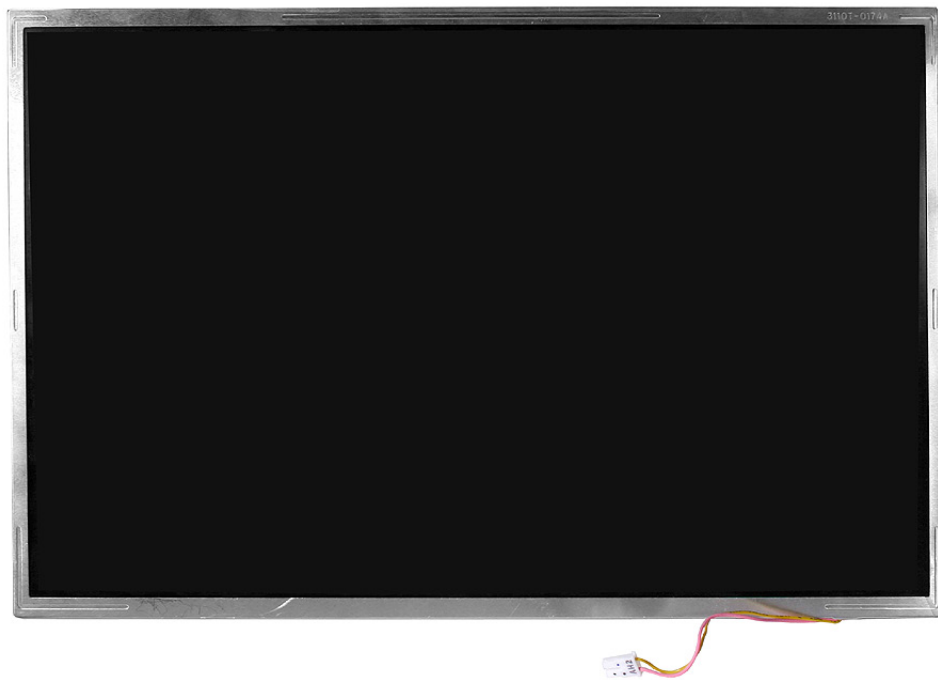

## Procedure

1. With all of the preliminary steps performed, turn over the LCD panel and check for any remaining strips of tape.

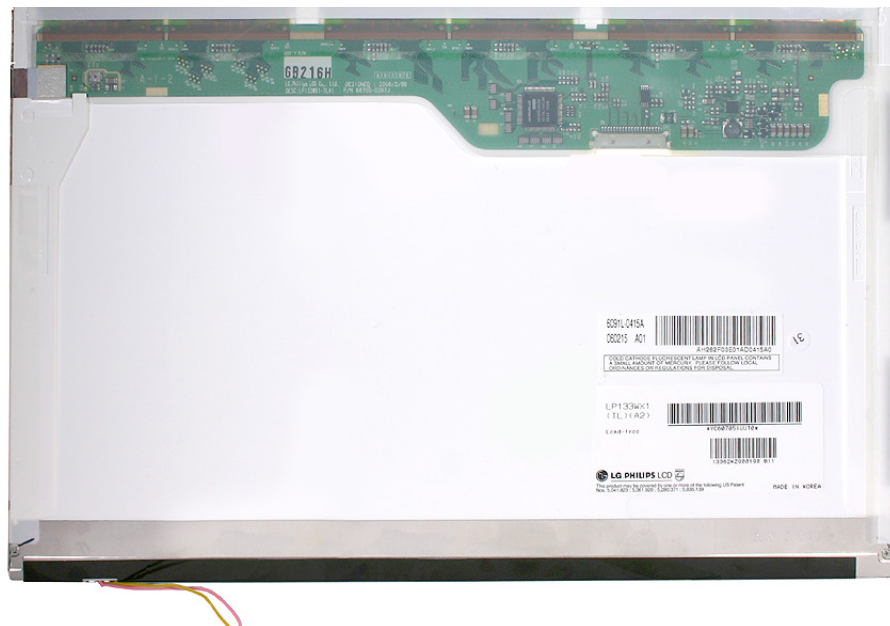

- 
2. Install the replacement LCD panel, and reassemble and test the computer.

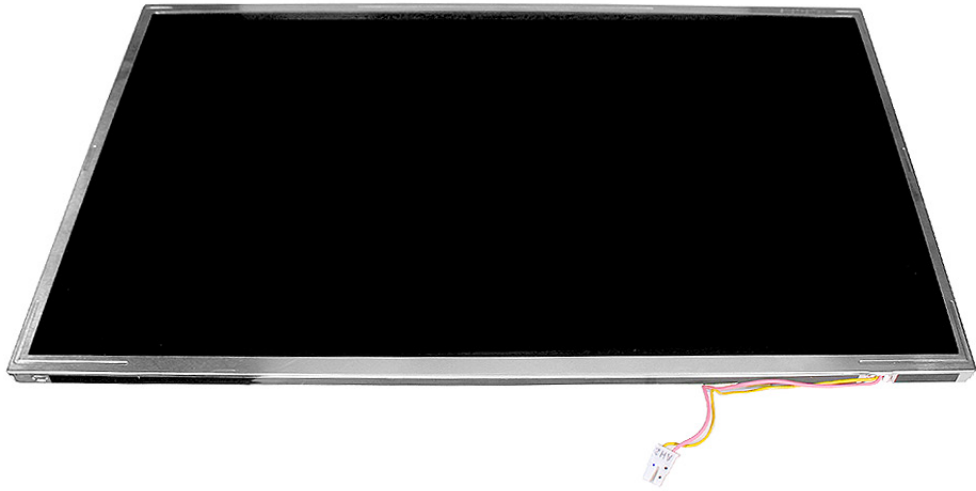

**Replacement Note:** When reassembling the computer, make sure the LCD cable is bent, but not pinched or damaged.

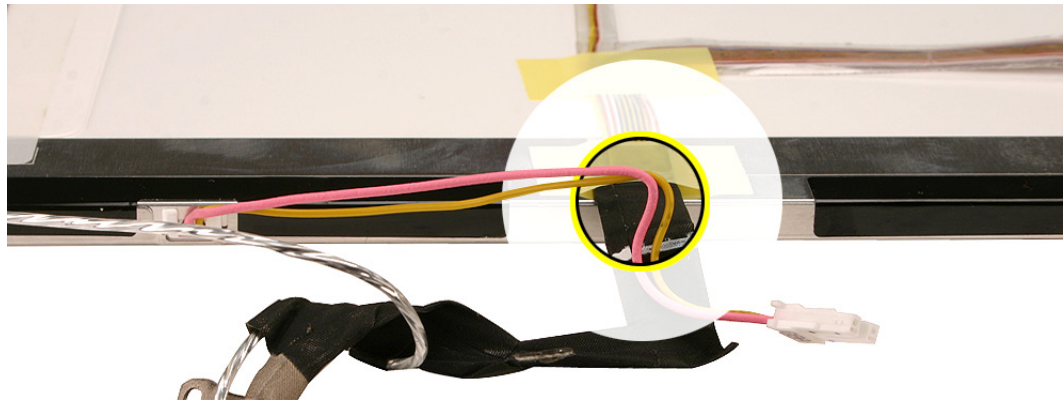

---

**Replacement Note:** Start by connecting the LVDS cable and USB flex line first. Then place the tape before continuing with the rest of the reassembly.

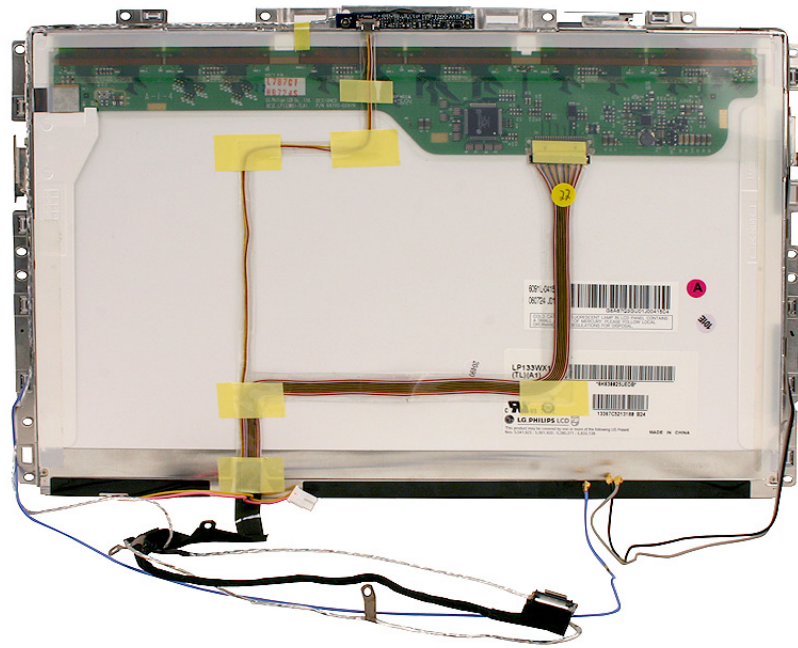

**Important:** Notice the correct horizontal placement of the tape. If placed vertically, the tape can be visible through the Apple logo on the display rear housing. Before reassembling the display, check the back of the LCD panel to make sure the tape is placed horizontally, as shown.

With the LCD panel in the rear housing, but before securing the panel screws, hold the panel in place and tilt up the housing. Shine a bright light at the center of the screen, and check that the Apple logo shows no discoloration. If discoloration is visible, carefully reapply the tape away from the logo area. Once fully assembled, turn on the computer to verify the color uniformity of the logo.

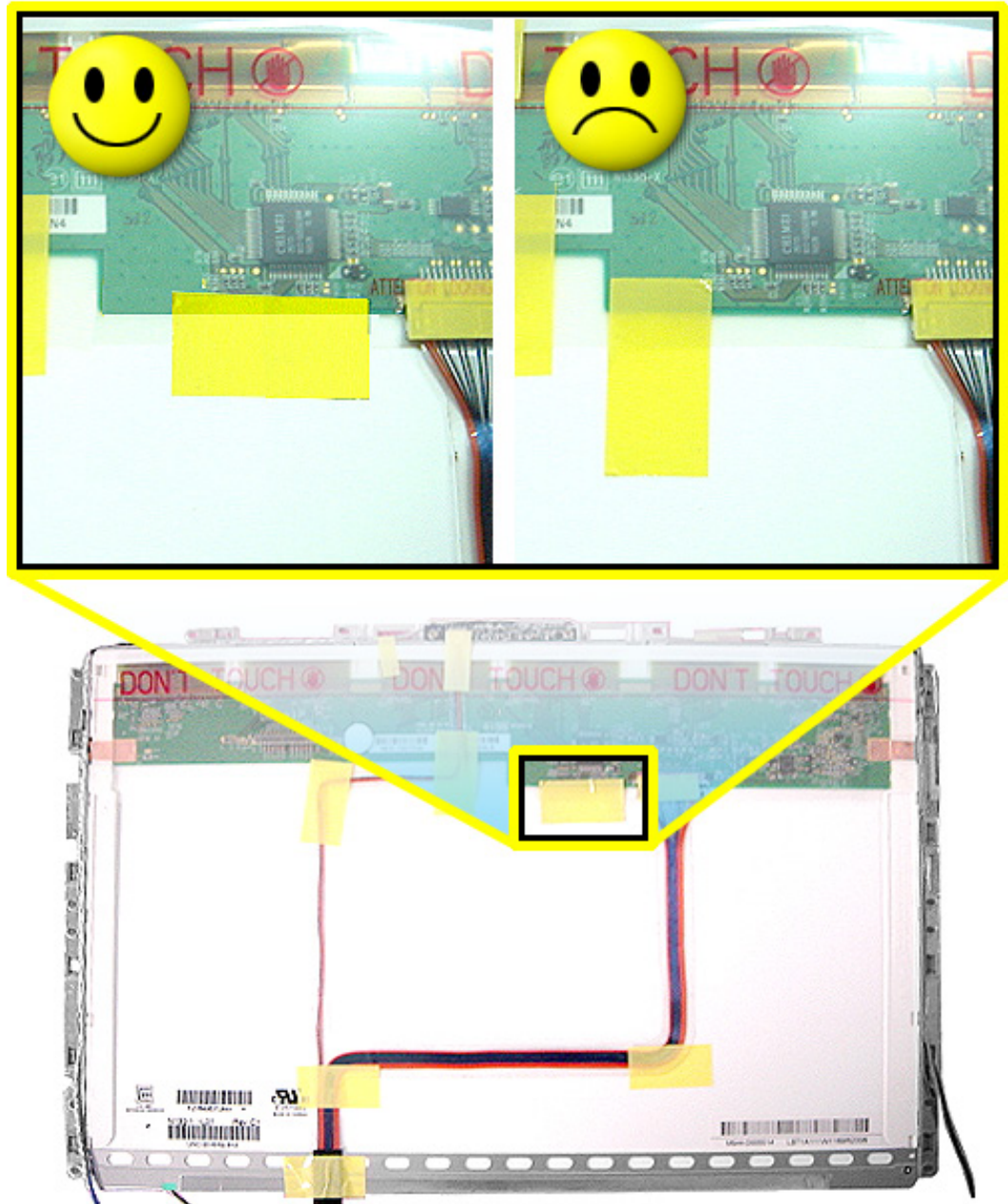

**Replacement Note:** Make sure the LVDS cable is correctly matched with its corresponding LCD panel.



# Antenna Receptors and Cables, Top and Left

## Tools

- Soft cloth
- ESD wrist strap and mat
- Magnetic Phillips #0 screwdriver
- Black stick (Apple part no. 922-5065) or other nonconductive nylon or plastic flatblade tool
- Jeweler's flatblade screwdriver

## Preliminary Steps

Before you begin, remove

- [Battery](#)
- [RAM door](#)
- [Top case with keyboard](#)
- [Optical drive](#)
- [Clutch block, left](#)
- [Clutch block, right](#)
- [Display module](#)
- [Display bezel](#)
- [Clutch cover](#)
- [Spacers at bezel scoops](#)
- [Bezel scoops](#)
- [Display rear housing](#)

## Part Location

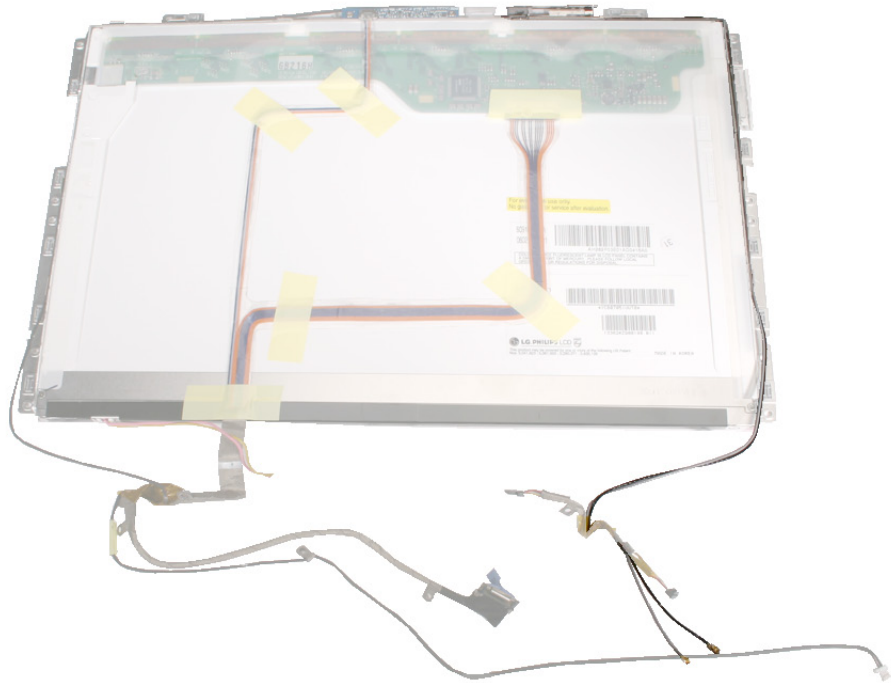

## Procedure

Notice that the antenna cables are two separate cables (black and gray) that run along the left front side of the LCD panel brace. The gray cable is also routed over the top corner of the LCD panel.

1. Carefully unroute the cables from the left brace.

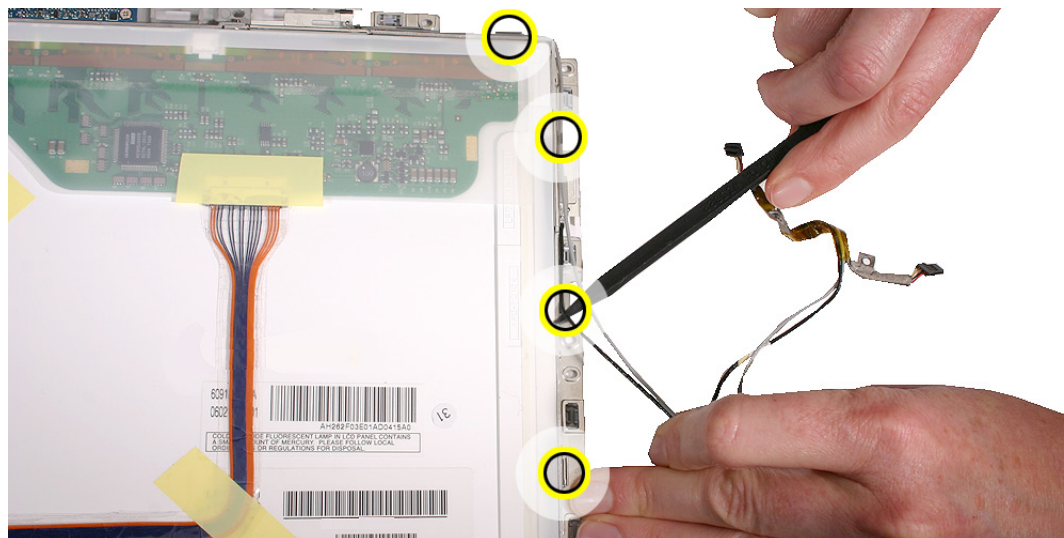

2. Remove the three identical 3-mm long screws from the left brace.

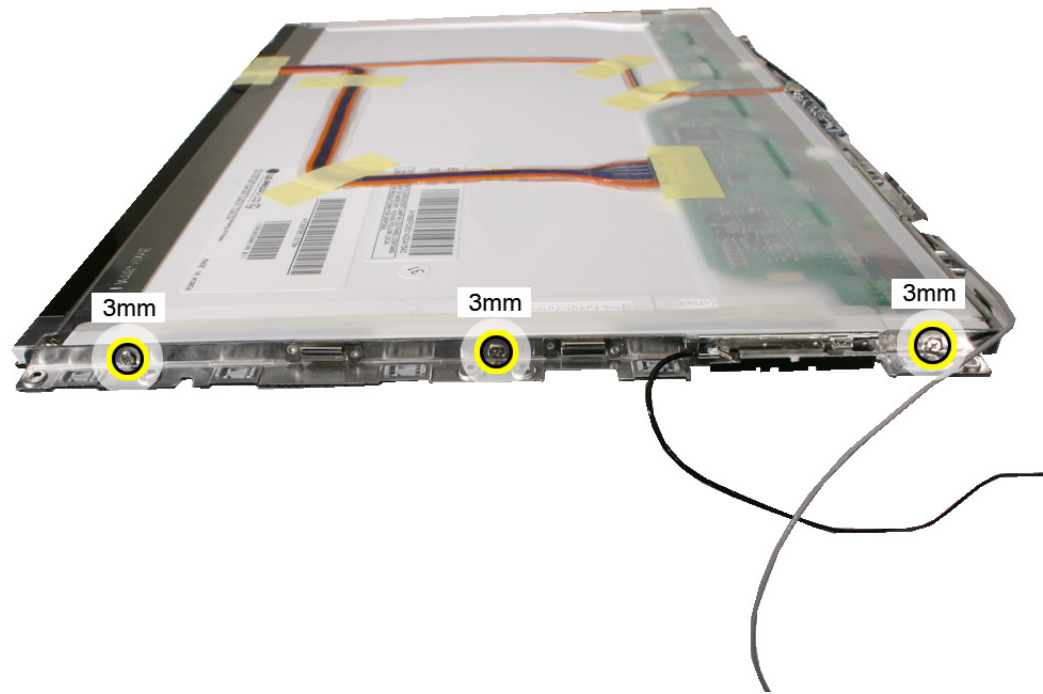

3. Rotate the top corner of the LCD panel and remove the 3-mm long screw from the left brace and camera bracket.



4. Slightly lift up the end of the camera bracket to free the locator pin on the end of the left brace.

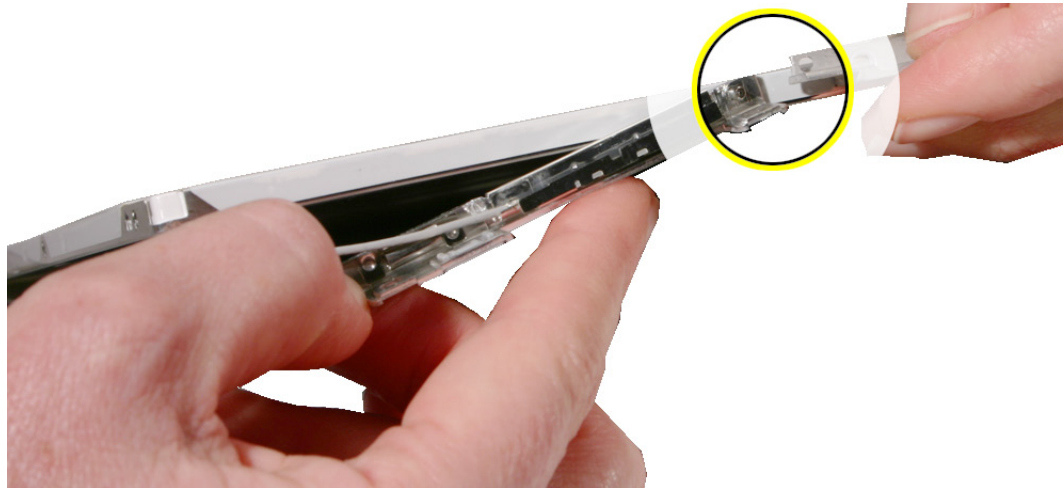

**Replacement Note:** To avoid straining cables, be sure to align the locator pin and hole before sliding on the left brace.

5. Move the left brace away from the LCD panel assembly, and use a jeweler's flatblade screwdriver placed underneath the antenna receptor to carefully pry up the antenna receptor.

**Important:** To support the solder joint where the cable meets the receptor, keep the antenna cable in the last brace tab while loosening the receptor from the brace.



**Caution:** The antenna receptors are friction-fit with a metal fold that hooks onto the left brace. The antenna receptors are delicate and easily bent. Do not press on nor pinch the antenna receptors.

---

**Replacement Note:** Secure the antenna receptors by placing them over the recessed brace area and pressing only on the metal fold. You will hear an audible snap when they are installed.



6. Install the replacement antenna cables, and reassemble and test the computer.



# LCD Panel Assembly

**Important:** Although the LCD panel assembly is not an available subassembly part, it must be removed to replace other display parts.

## Tools

- Soft cloth
- ESD wrist strap and mat
- Magnetic Phillips #0 screwdriver
- Black stick (Apple probe tool, part no. 922-5065) or other nonconductive nylon or plastic flatblade tool
- Flashlight or bright lamp

## Preliminary Steps

Before you begin, remove

- [Battery](#)
- [RAM door](#)
- [Top case with keyboard](#)
- [Optical drive](#)
- [Clutch block, left](#)
- [Clutch block, right](#)
- [Display module](#)
- [Display bezel](#)
- [Clutch cover](#)
- [Spacers at bezel scoops](#)
- [Bezel scoops](#)
- [Inverter board](#)

---

## Part Location



---

## Removal Procedure

1. **Important:** Study the cable routing around each hinge carefully. When reinstalling the LCD panel assembly for your first time, this can be a tricky area

**Note:** Although the images show the inverter board installed, it should be removed previously as listed in the preliminary steps.

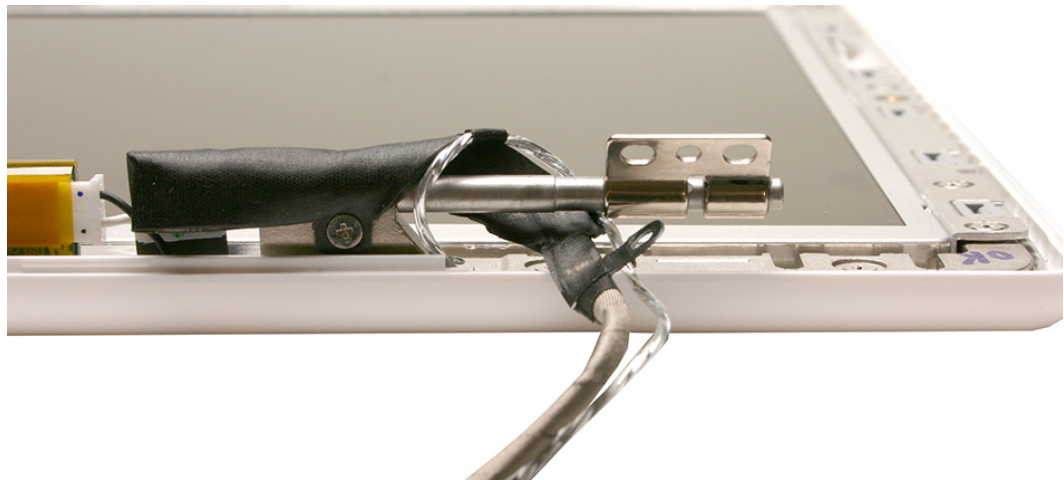
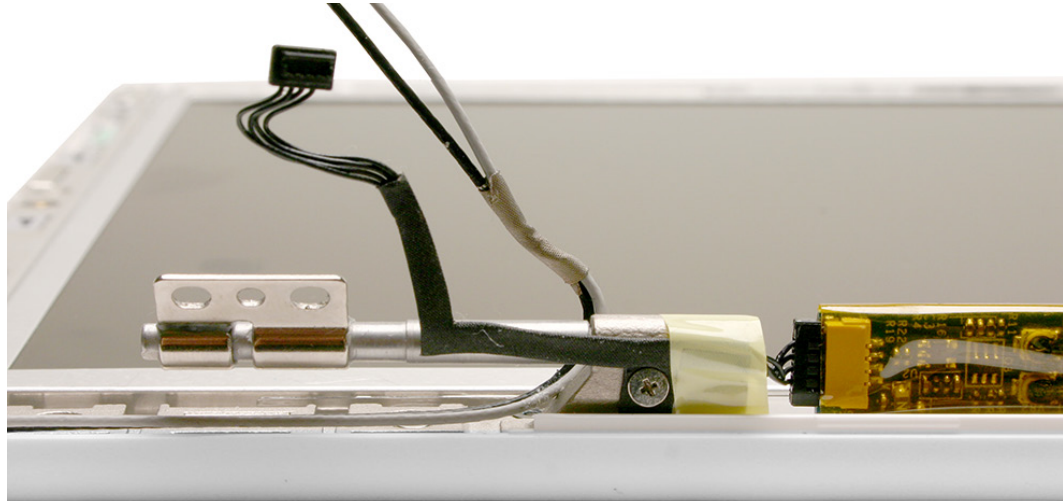

- 
2. Following the order shown, remove the twelve identical 4.5-mm long screws around the frame of the LCD panel.

**Caution:** To prevent scratches or other cosmetic damage to the display housing, use a soft cloth as a protective layer when removing the screws.

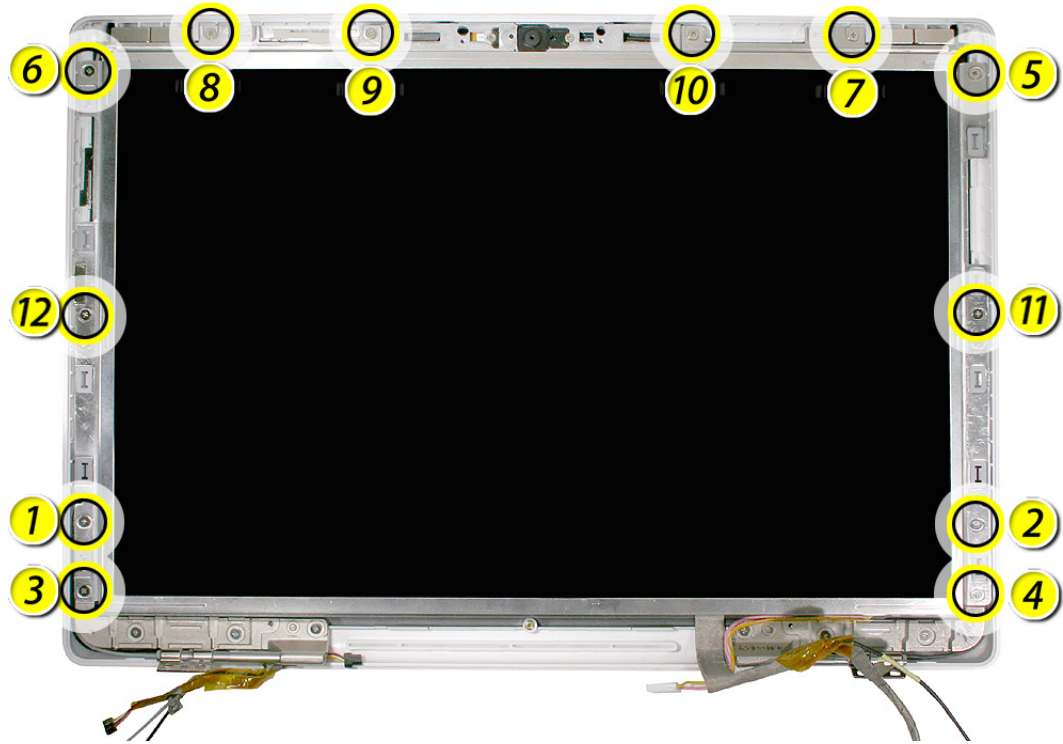

3. Remove the 3-mm long ground screw from the left hinge.  
**Note:** Although the images show the inverter board installed, it should be removed previously as listed in the preliminary steps.

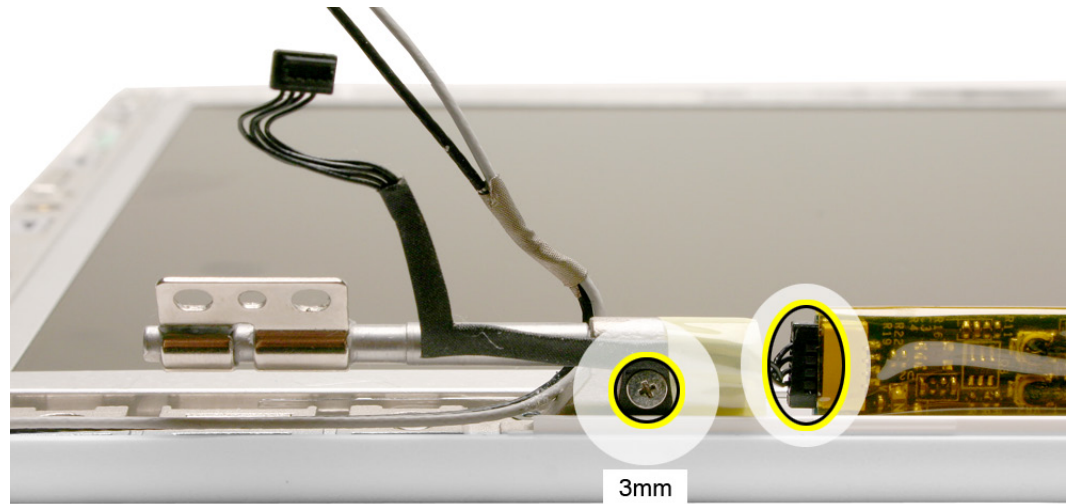

4. Starting at the bottom corners, lift the LCD panel with frame and attached cables off of the display rear housing.

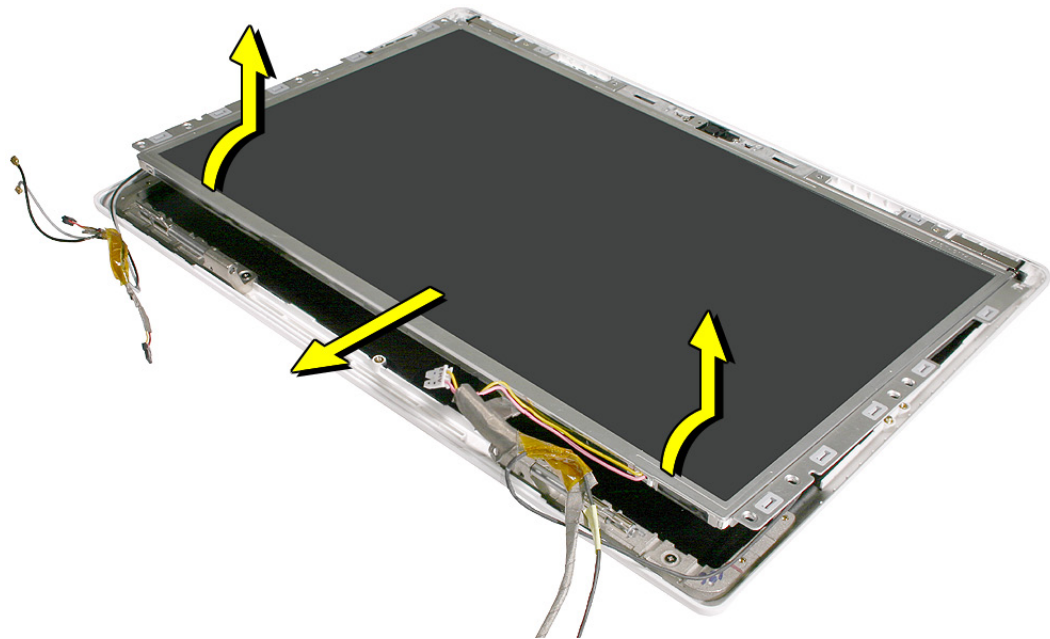

---

**Note:** The top of the camera bracket includes four thin, clear strips of double-sided tape. These are the camera spacers that are discussed later in this chapter. Be sure to reinstall them if they become loose.

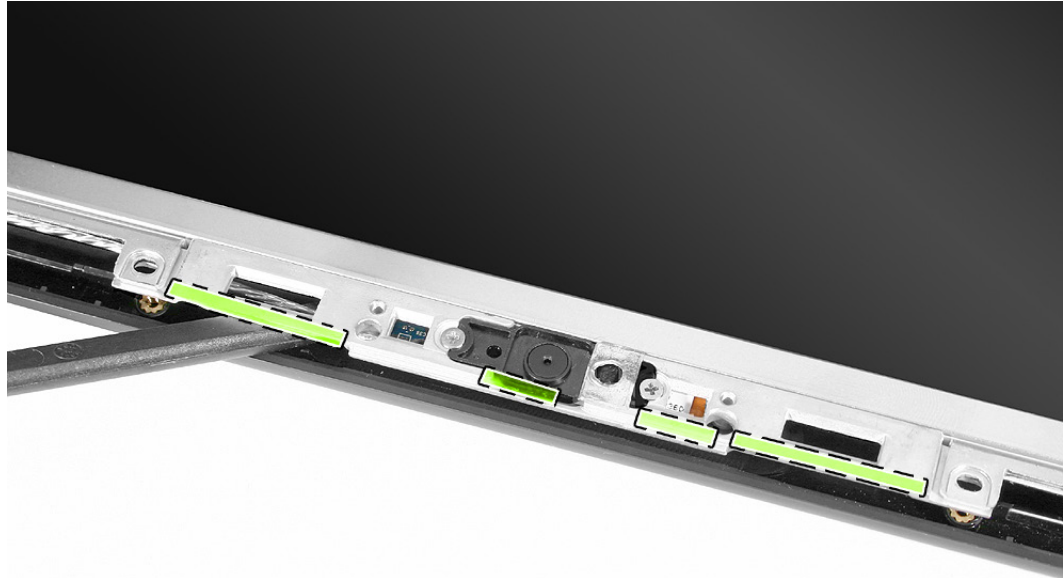

**Note:** The magnets located in the display rear housing may come loose while lifting out the LCD panel assembly from the display rear housing. Don't lose the magnet pairs (on top corners) that function as the latch.

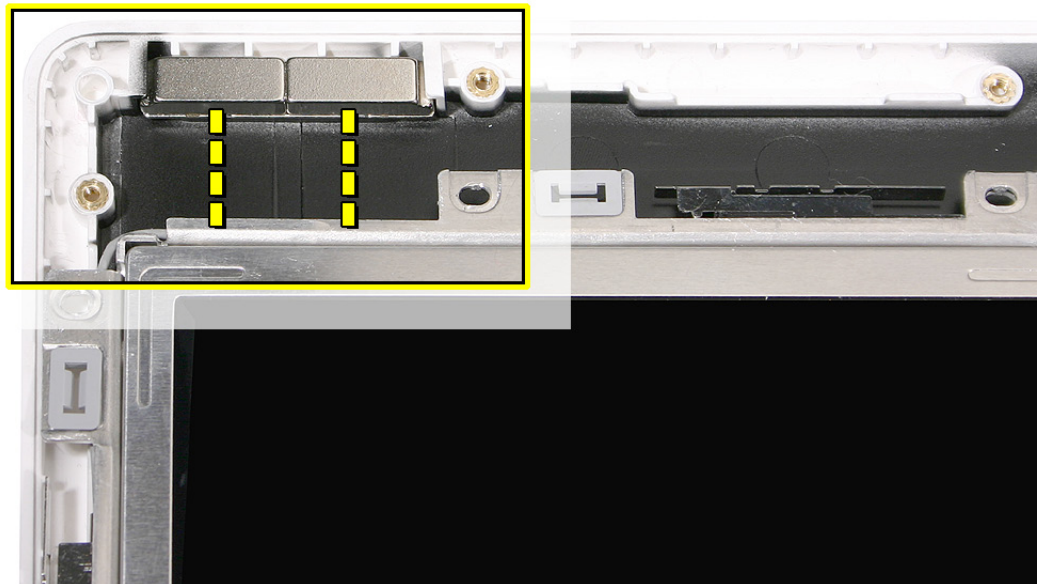

5. Set aside the LCD panel assembly so that the display is face-up if you are replacing any of its parts or any parts remaining in the display rear housing.
6. Reinstall the LCD panel assembly as follows.

## Reinstallation Procedure

**Important:** Correctly positioning the LCD panel assembly in the display rear housing requires careful attention to these areas:

- Delicate antenna receptors
- Magnets that catch on the bezel brace
- Cables to route properly
- Locator pins on display rear housing

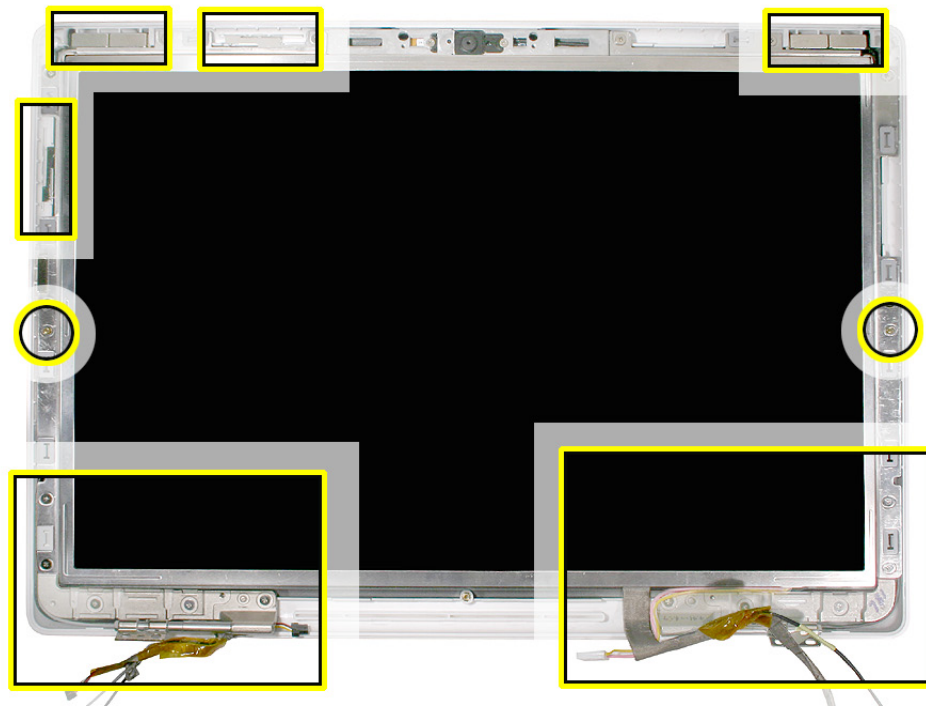

**Caution:** Hold the LCD panel assembly at the bezel brace sides or opposite corners. Do not press or pinch the antenna receptors or anywhere on the LCD panel itself.

1. Check the underside of the LCD panel assembly to make sure all cables are connected and routed properly:
  - LVDS cable
  - USB line to camera board
  - Black and gray antenna receptor cables
  - Microphone cable

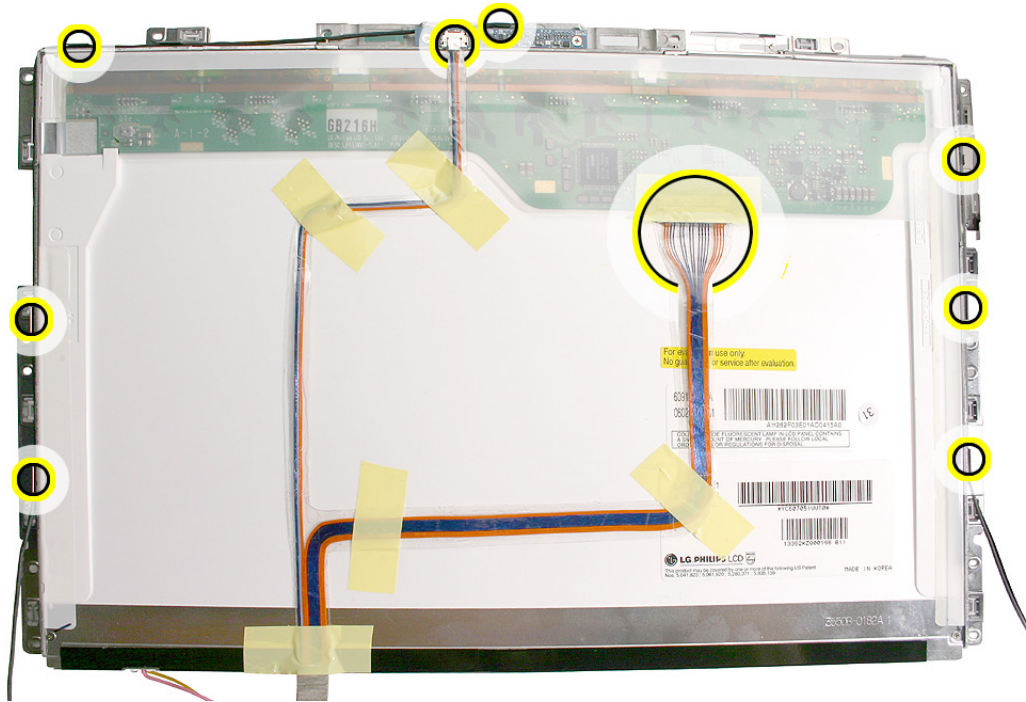

2. **Important:** Notice the correct horizontal placement of the tape. If placed vertically, the tape can be visible through the Apple logo on the display rear housing. Before reassembling the display, check the back of the LCD panel to make sure the tape is placed horizontally, as shown.

With the LCD panel in the rear housing, but before securing the panel screws, hold the panel in place and tilt up the housing. Shine a bright light at the center of the screen, and check that the Apple logo shows no discoloration. If discoloration is visible, carefully reapply the tape away from the logo area. Once fully assembled, turn on the computer to verify the color uniformity of the logo.

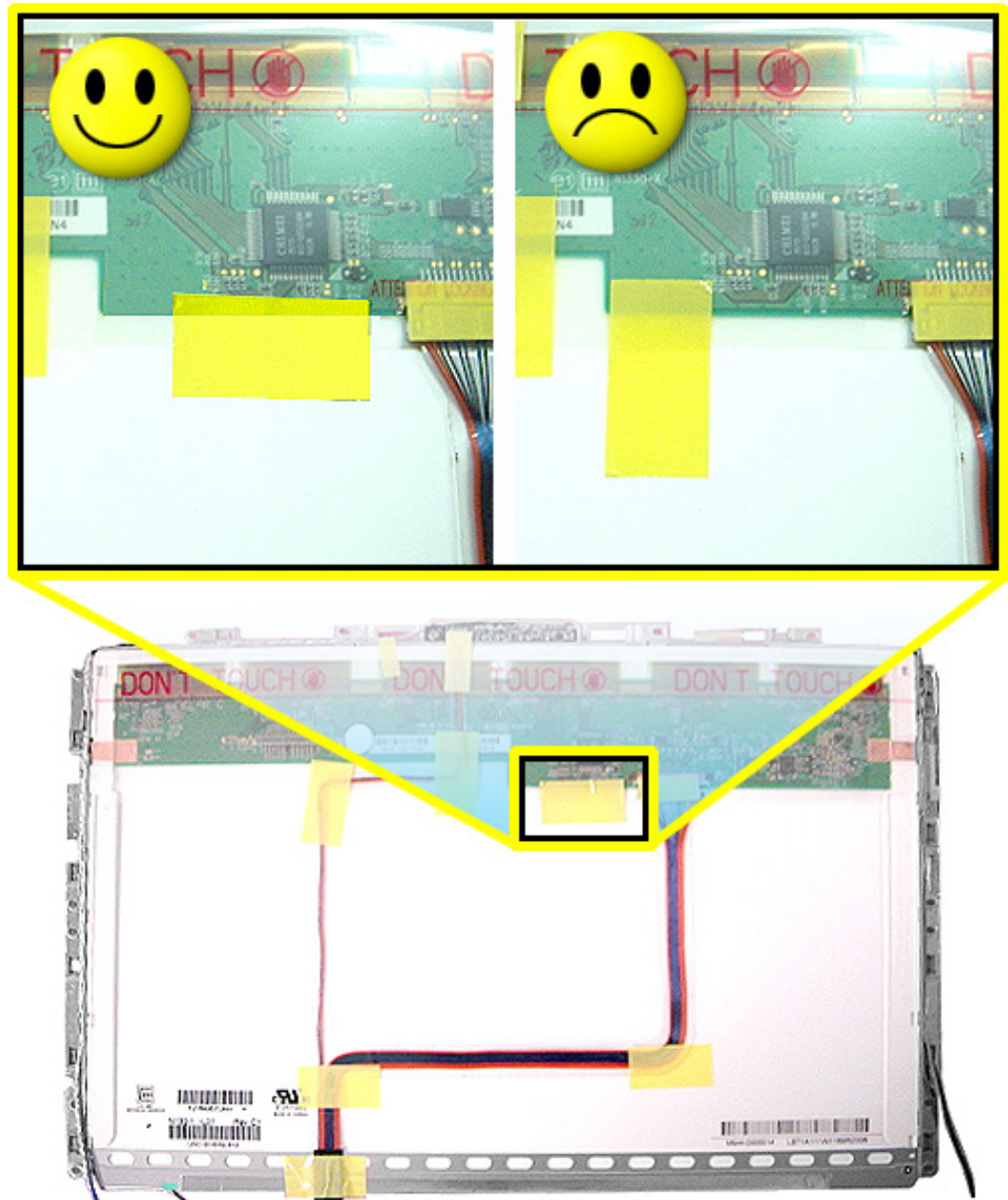

3. Check the display rear housing to make sure it includes the three magnets:
  - Sleep magnet on side
  - Two magnet pairs on top



4. **Important:** Insert the top corners of the LCD panel assembly into the display rear housing first. Use the notch in each bezel brace to help hold the cables in position. Then, before you set the LCD panel assembly into the display housing, route the cables under the bezel brace between the housing and the display hinge.

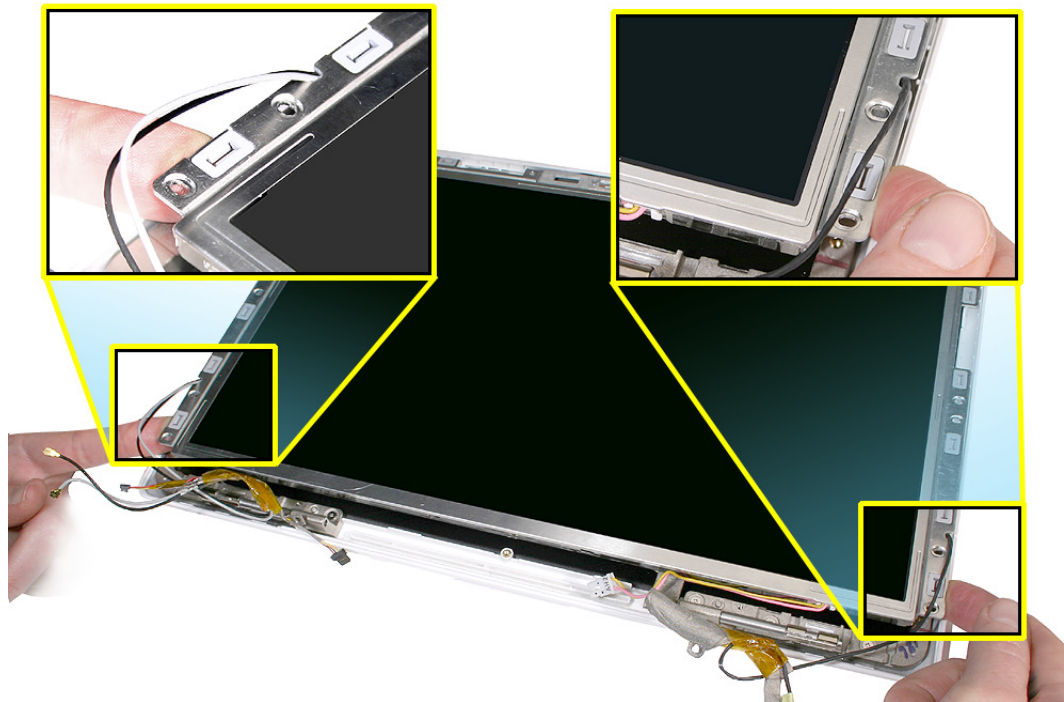

5. Set the magnets back into place if they come loose during this step.

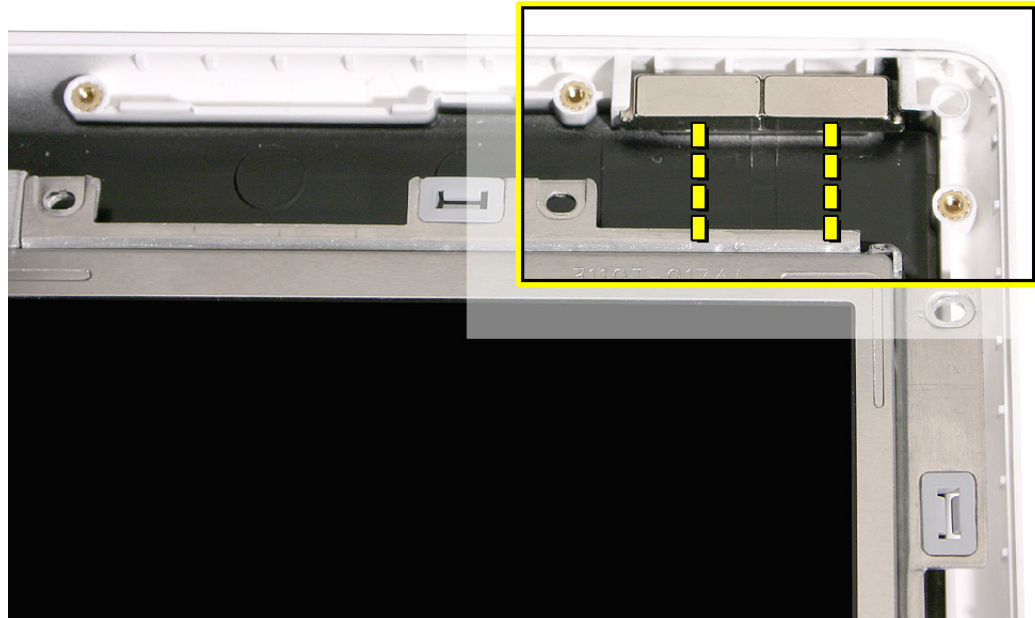

6. With the top corners secured, tilt up the bottom corners of the LCD panel assembly to route the antenna receptor cables and microphone cable around the recessed channel between the display hinge and the rear housing.





**Important:** The notch on each bezel brace indicates the point at which the cables start their path around the display hinge. Use a black stick at that notch to make sure the cables are not pinched and to guide them into the recessed channel.



7. Carefully pull the cables to make sure there is no slack as they route through the channels.



8. At the lower left corner, make sure the cables are routed as shown:
  - Microphone cable routes along the outer edge of the bezel brace
  - LCD panel cable tucks under LVDS cable
  - LVDS cable routes around clutch barrel and secures microphone cable with two integral adhesive strips

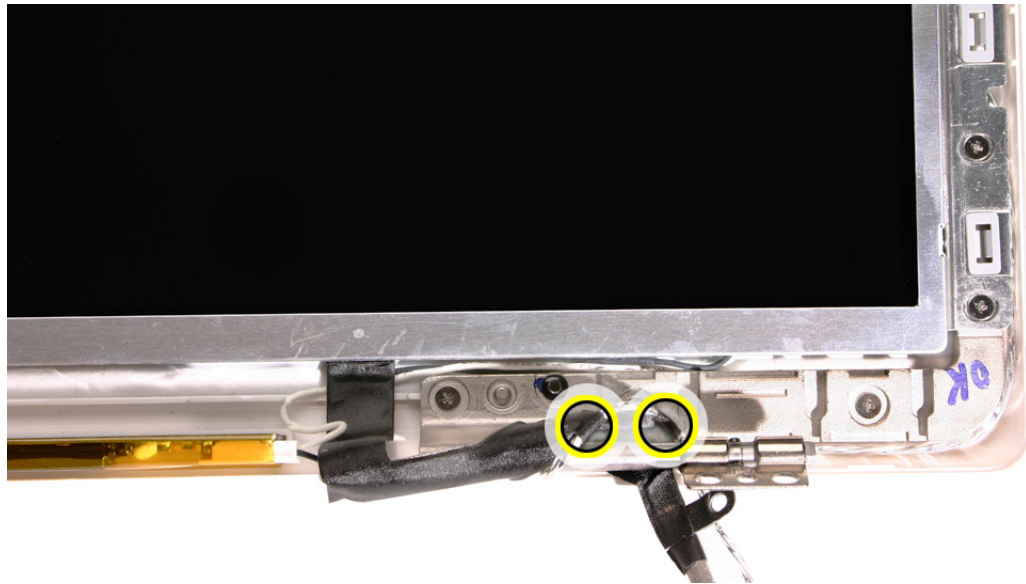

9. With the magnets and cables in place, slightly reposition the LCD panel assembly, if necessary, so that the bezel braces fit over the two locator pins (one pin at each side of the rear housing).



10. Starting with the screw holes just above the locator pins, install the 12 screws in the order shown:  
**Caution:** To prevent scratches or other cosmetic damage to the computer housing, use a soft cloth as a protective layer when installing the screws.

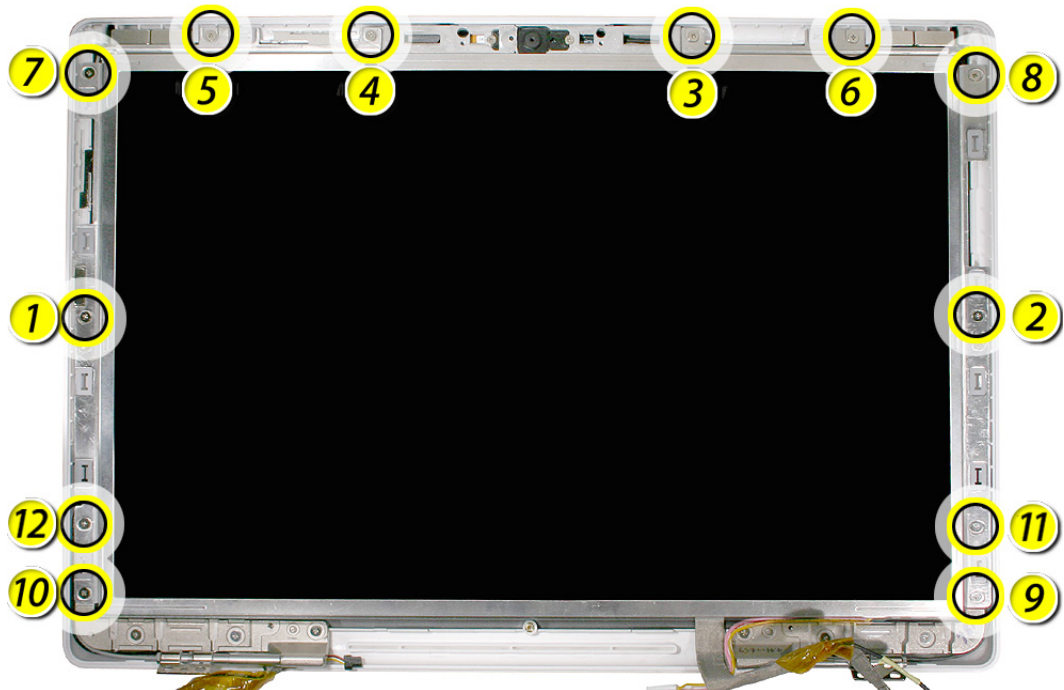

11. Reassemble and test the computer.



# Spacers at Camera Bracket

## Tools

- Soft cloth
- ESD wrist strap and mat
- Black stick (Apple part no. 922-5065) or other nonconductive nylon or plastic flatblade tool

## Preliminary Steps

Before you begin, remove

- [Battery](#)
- [RAM door](#)
- [Top case with keyboard](#)
- [Optical drive](#)
- [Clutch block, left](#)
- [Clutch block, right](#)
- [Display module](#)
- [Display bezel](#)
- [Clutch cover](#)
- [Inverter board](#)
- [LCD panel assembly](#)

## Part Location



---

## Procedure

1. Note the placement of the four thin, clear strips that attach to the camera bracket with double-sided adhesive.
2. Using a black stick, remove the four strips.

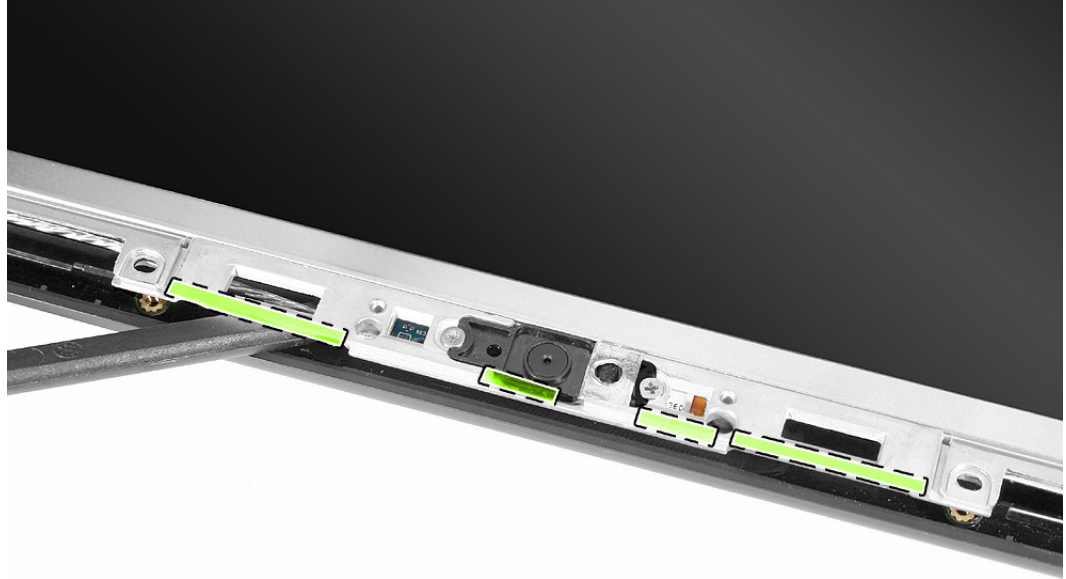

**Replacement Note:** Position the replacement adhesive strips so that they extend slightly over the camera bracket but do not overlap the outer edge of the display rear housing.

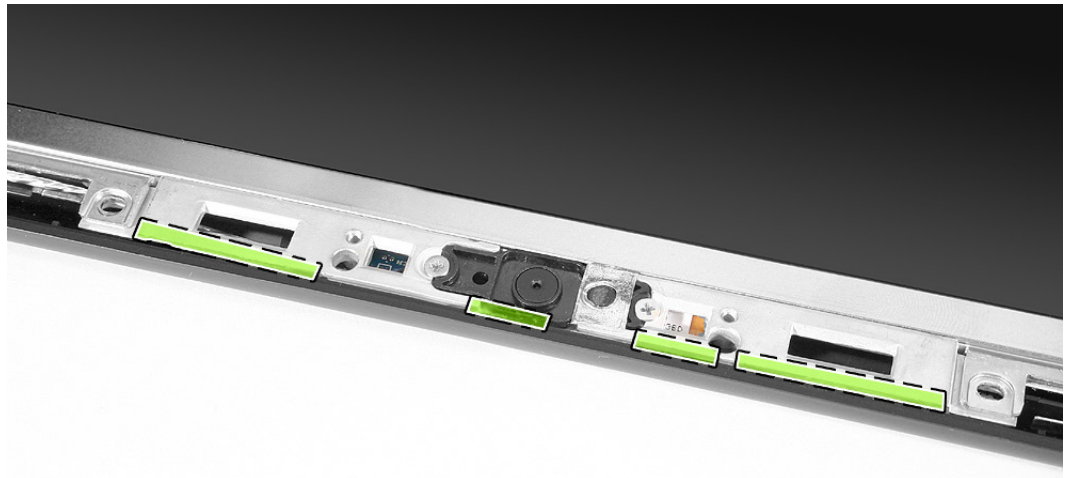

3. Install the replacement camera spacers, and reassemble and test the computer.



# Camera Assembly

## Tools

- Soft cloth
- ESD wrist strap and mat
- Magnetic Phillips #0 screwdriver
- Black stick (Apple part no. 922-5065) or other nonconductive nylon or plastic flatblade tool

## Preliminary Steps

Before you begin, remove

- [Battery](#)
- [RAM door](#)
- [Top case with keyboard](#)
- [Optical drive](#)
- [Clutch block, left](#)
- [Clutch block, right](#)
- [Display module](#)
- [Display bezel](#)
- [Clutch cover](#)
- [Inverter board](#)
- [LCD panel assembly](#)
- [Spacers at camera bracket](#)

## Part Location

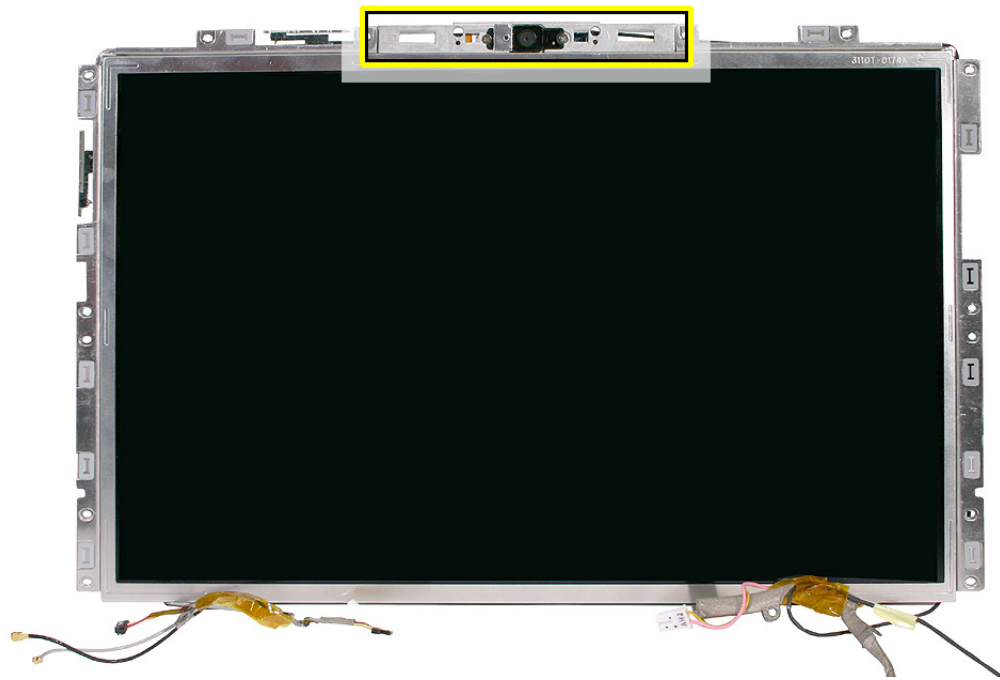

## Procedure

1. With the LCD panel face-down on a clean, soft cloth, disconnect the USB camera cable (pull the connector straight down).
2. Remove the two 2-mm long screws from the camera board.

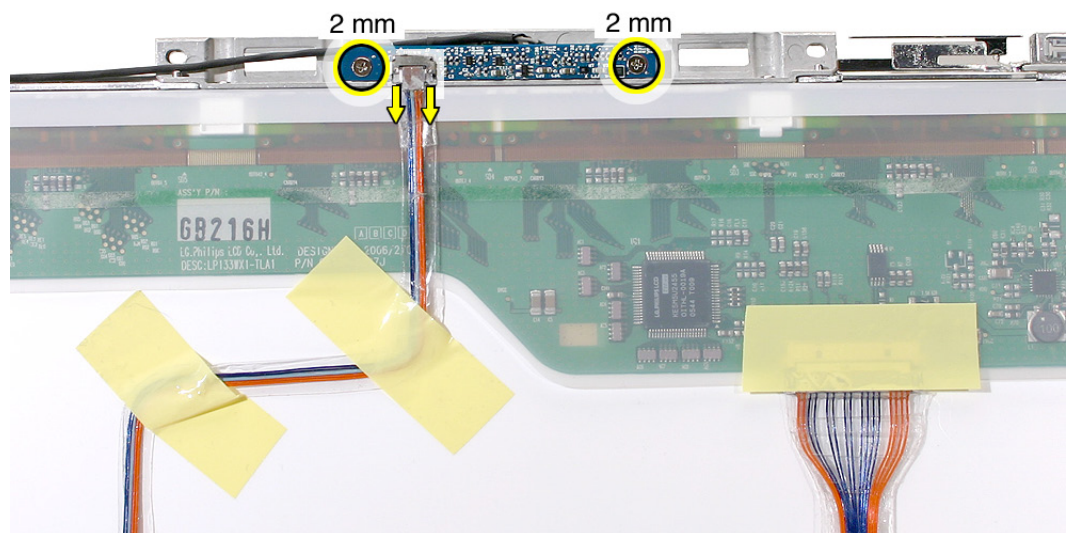

3. Tilt up the camera board and use a black stick to gently pry up the microphone cable gasket from the panel frame.

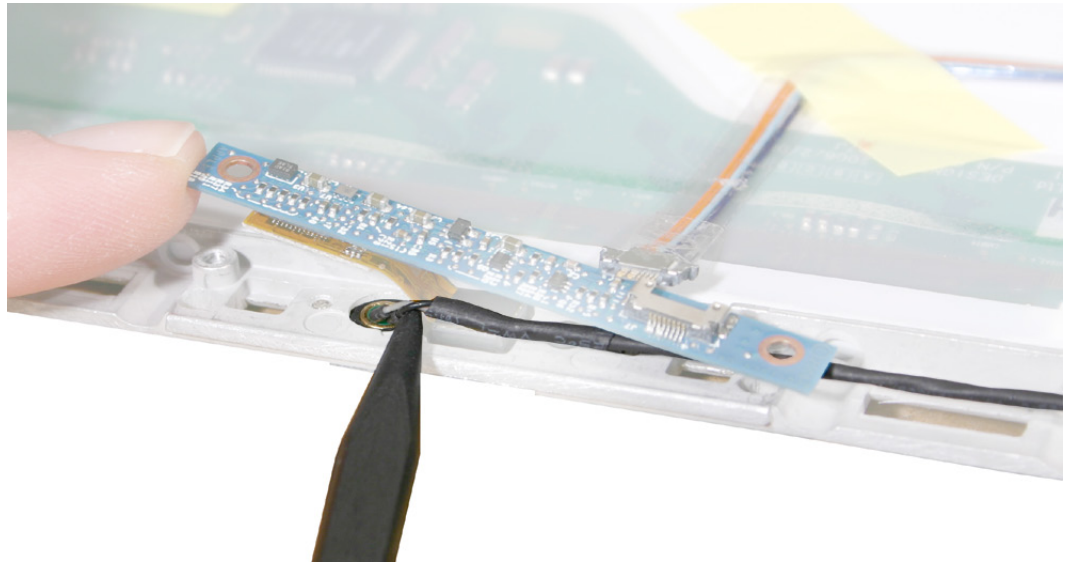

**Replacement Note:** Make sure the microphone gasket fits snug in the frame and that the microphone cable runs along the top of the camera frame before installing the screws.

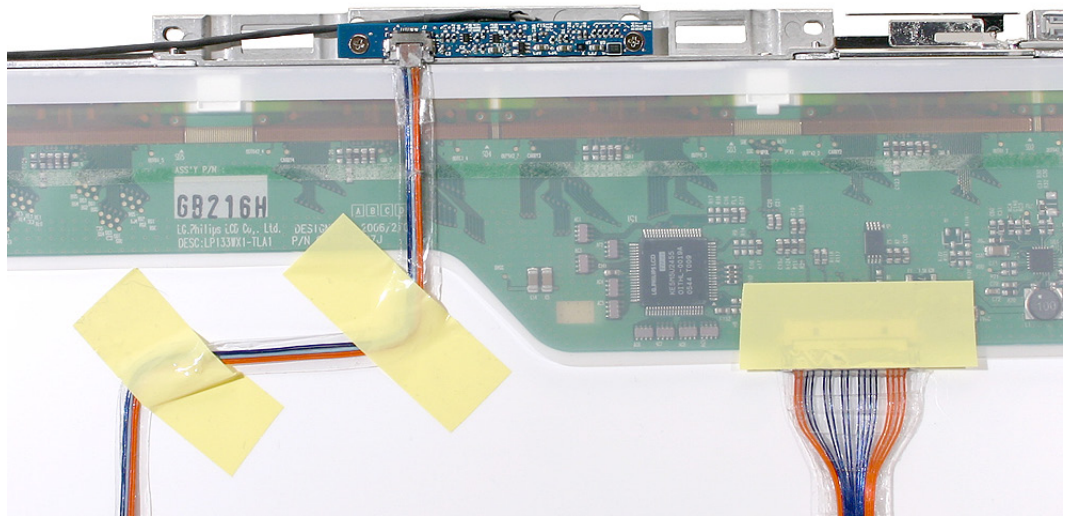

4. Peel up the single strip of tape that holds the microphone cable in place at the camera bracket.

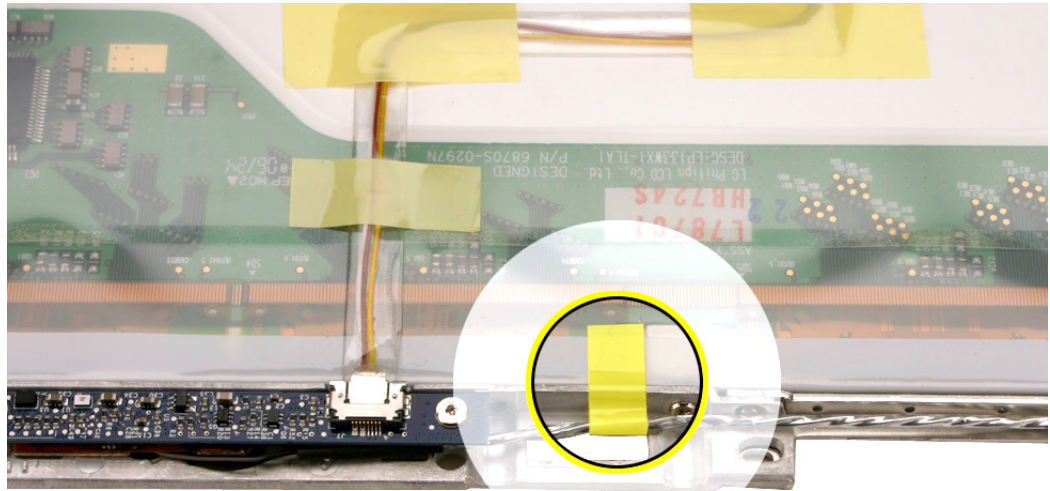

**Replacement Note:** Be sure to install a replacement strip of tape to hold the microphone cable in place and keep the cable away from areas where it could be pinched when the panel is reinstalled. Make sure the tape wraps around to the front of the camera bracket.



5. Hold the LCD panel assembly upright so you can access the two 3-mm long screws that secure the camera bracket to the top of the LCD panel. Remove the two screws.

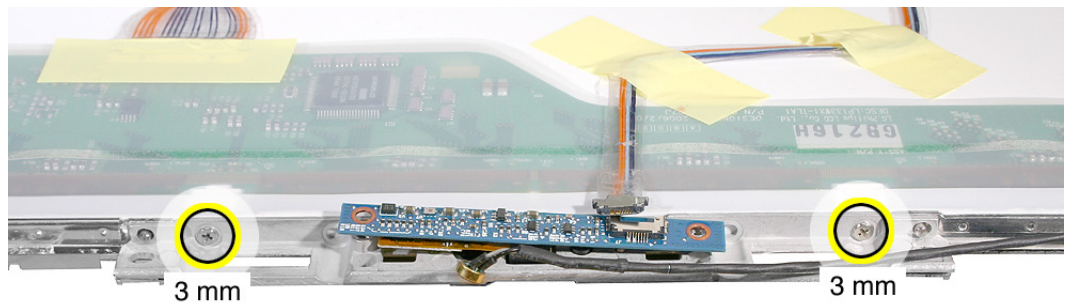

6. Lift off the camera bracket from the locator pins on the bezel braces. Do not remove the camera board from the bracket.

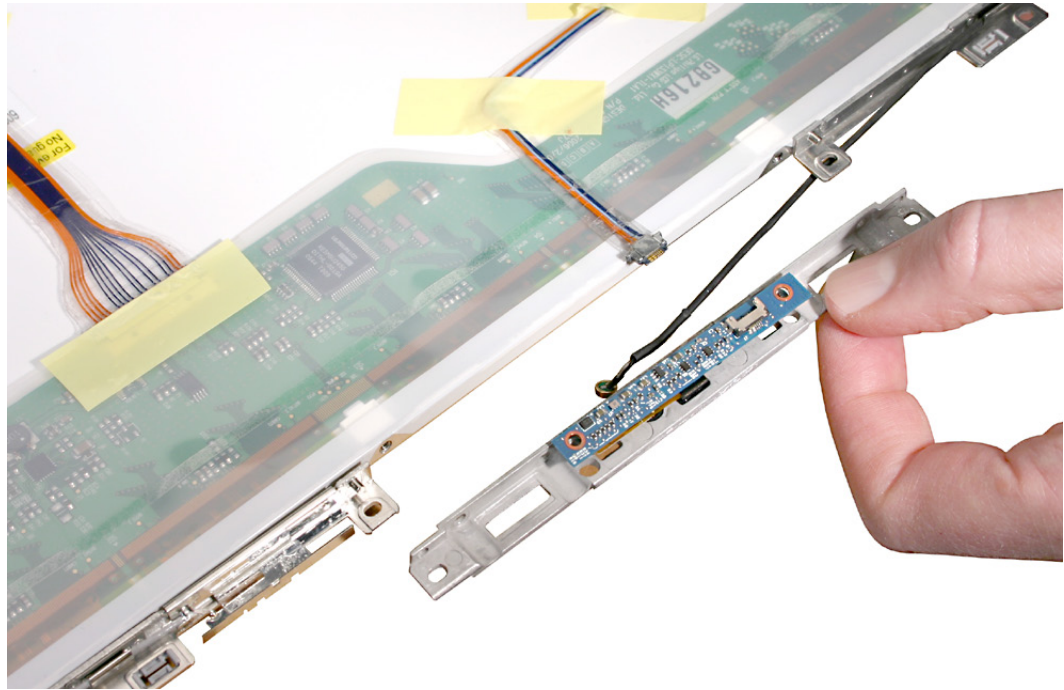

7. Install the replacement camera assembly, and reassemble and test the computer.

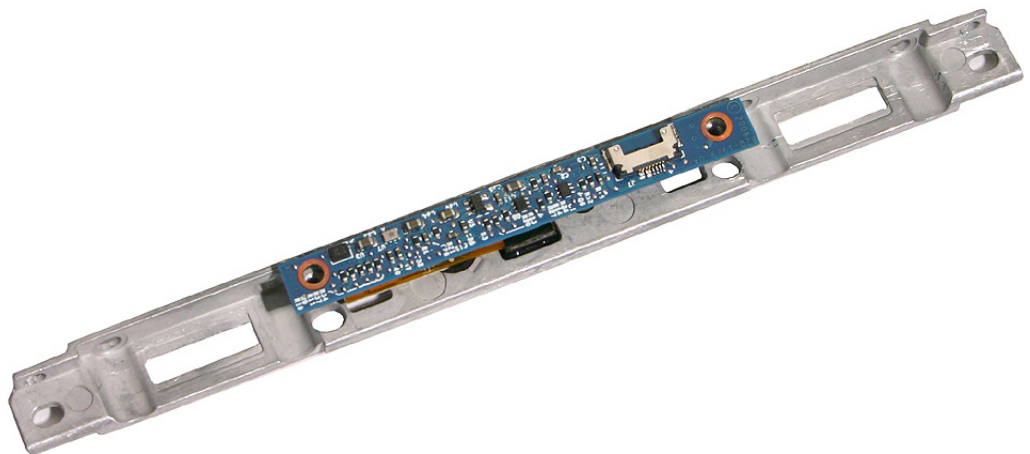

**Replacement Note:** The camera assembly includes:

- Camera bracket
- Camera board
- Camera in plastic case
- Flex cable from camera case to camera board
- Screws

**Replacement Note:** Be sure to reinstall the microphone in the gasket before securing the 2-mm long camera board screws.

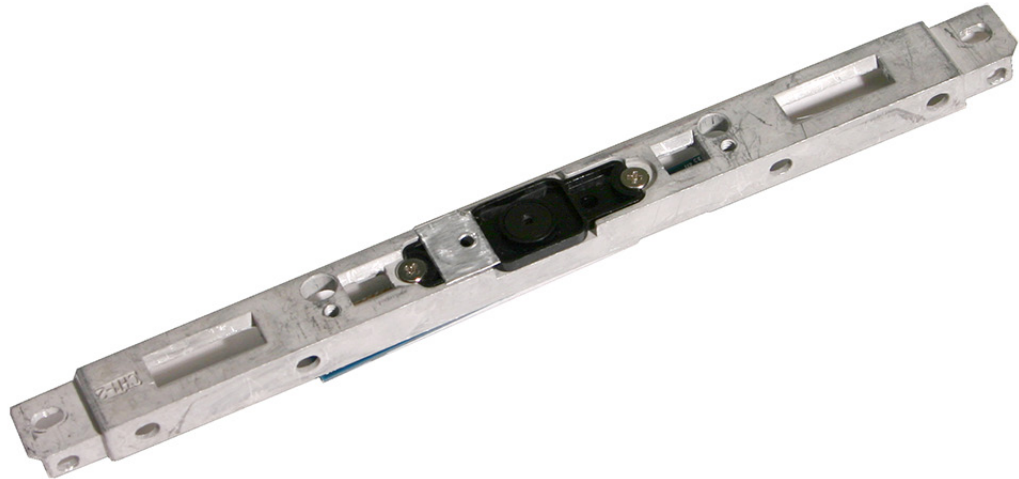

**Replacement Note:** When reinstalling the USB line, no copper contacts should be visible. Reinstall the cable if you can see copper contacts.

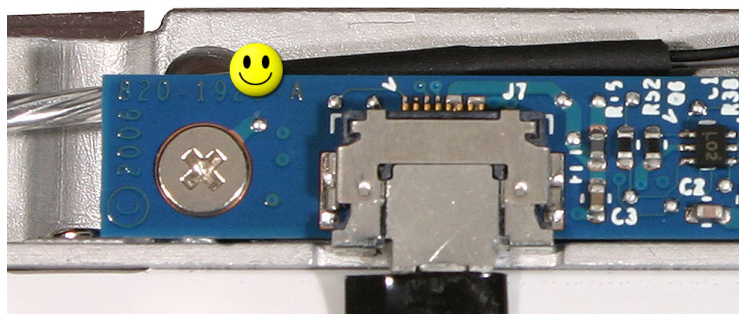
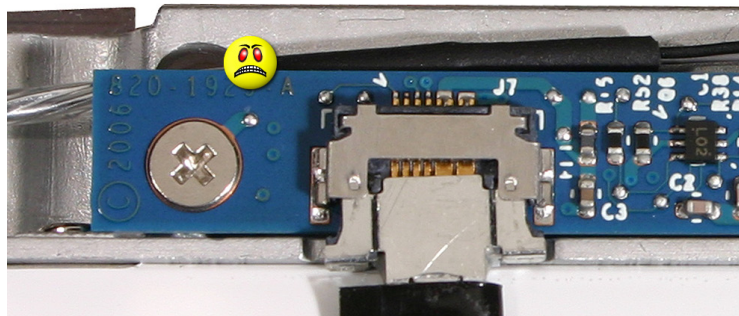



# LVDS Cable with USB Line

## Tools

- Soft cloth
- ESD wrist strap and mat
- Black stick (Apple part no. 922-5065) or other nonconductive nylon or plastic flatblade tool
- Permanent marking, felt-tip pen

## Preliminary Steps

Before you begin, remove

- [Battery](#)
- [RAM door](#)
- [Top case with keyboard](#)
- [Optical drive](#)
- [Clutch block, left](#)
- [Clutch block, right](#)
- [Display module](#)
- [Display bezel](#)
- [Clutch cover](#)
- [Spacers at bezel scoops](#)
- [Bezel scoops](#)
- [Inverter board](#)
- [LCD panel assembly](#)

---

## Part Location

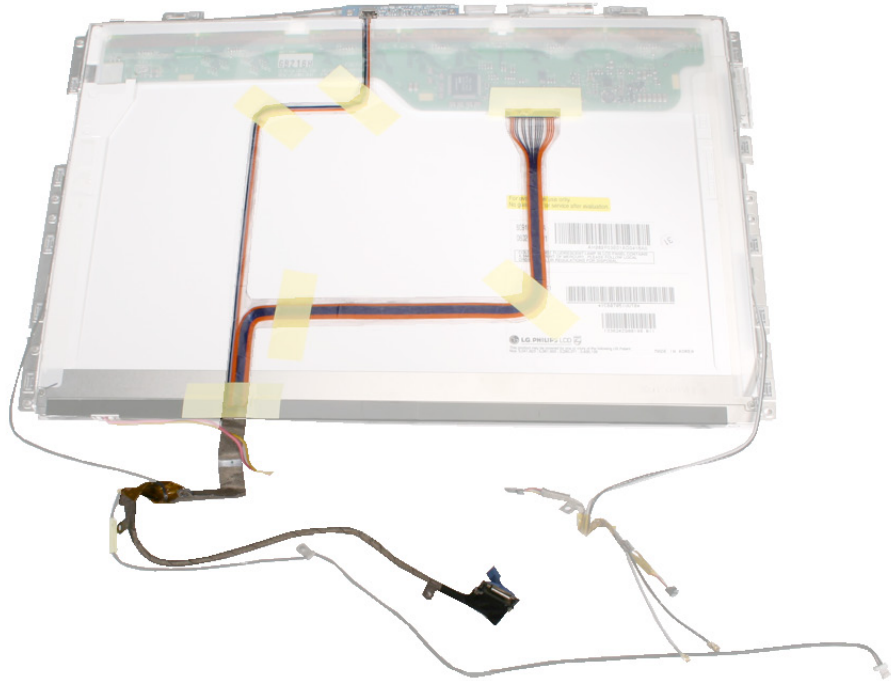

## Procedure

1. Note the placement of the strips of tape that secure the LVDS cable and the USB line to the LCD panel.

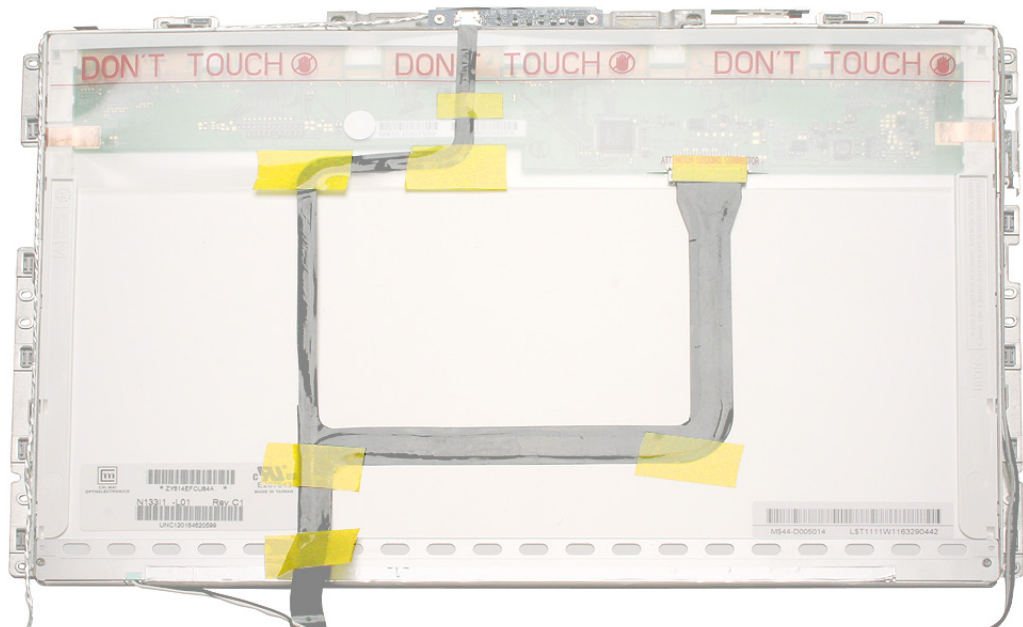

2. Because the protective sheath for the flex cables can be delicate, use light pressure to hold the cables in place as you carefully peel up the strips of tape just enough to free the cables.

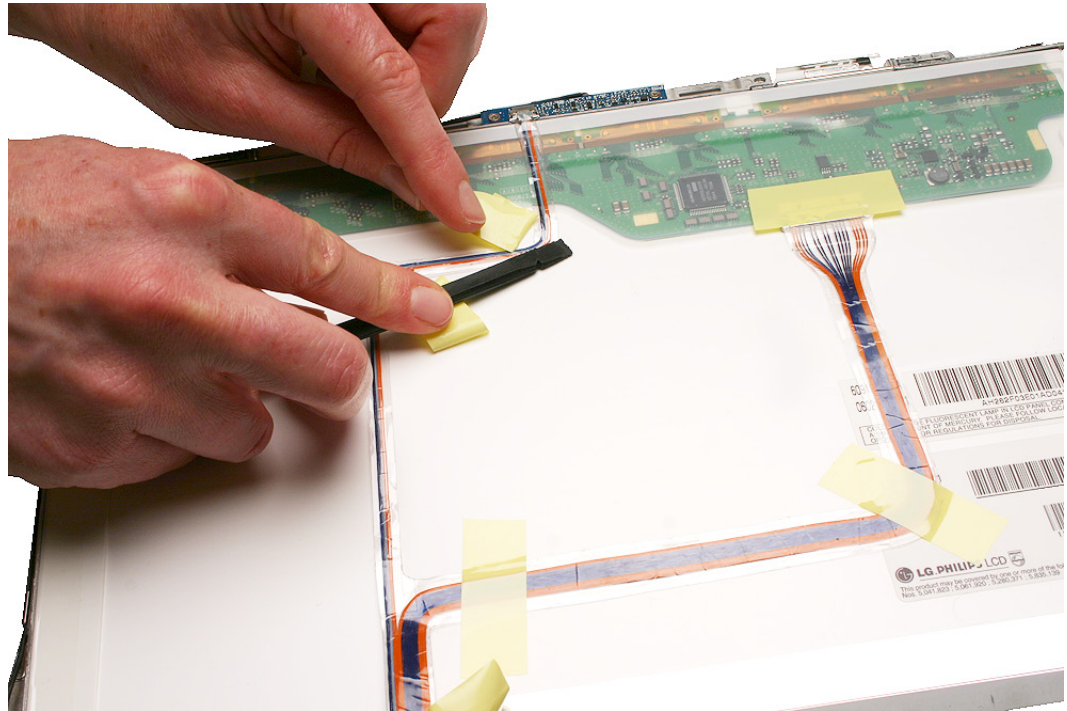

3. Disconnect the LVDS cable by pulling the connector straight down from the connector on the LCD panel.

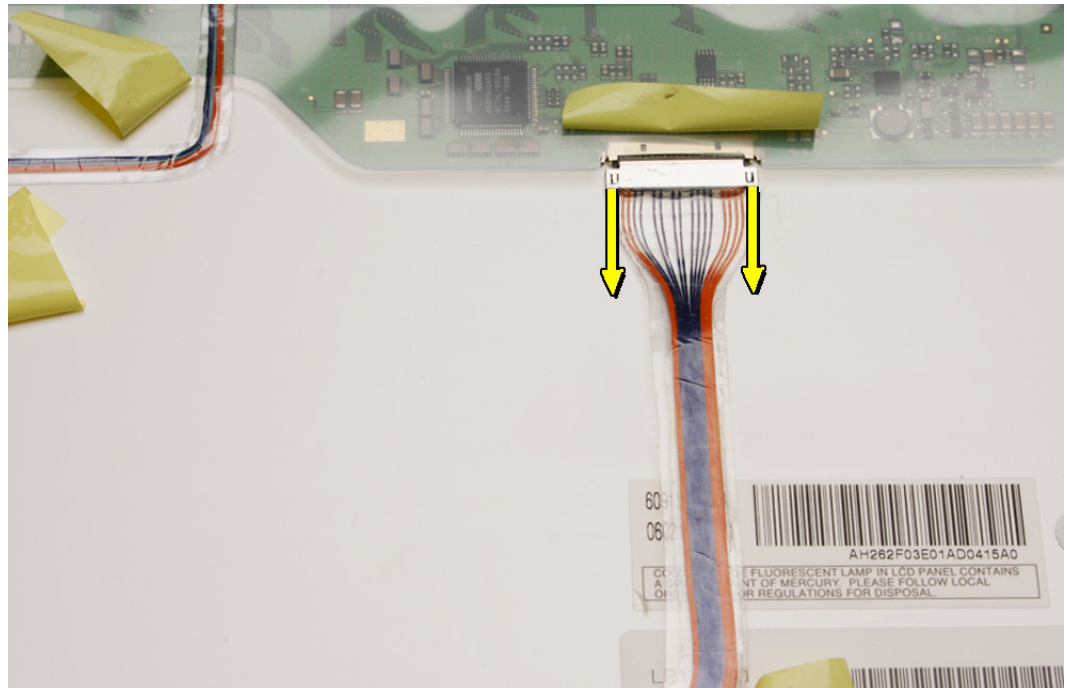

4. Disconnect the USB line by using a black stick and your fingernail to slide the connector straight down from the camera board.

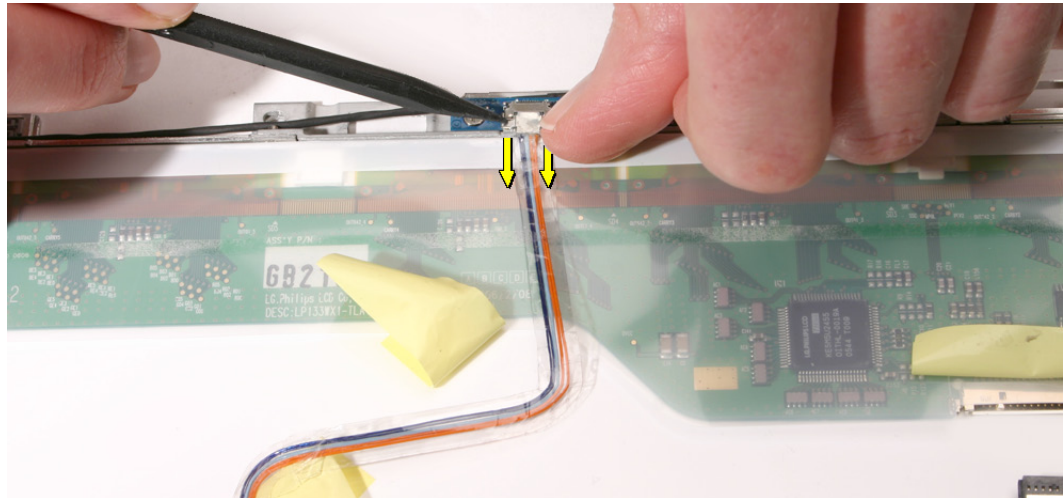

**Replacement Note:** When reinstalling the USB line, no copper contacts should be visible. Reinstall the cable if you can see copper contacts.

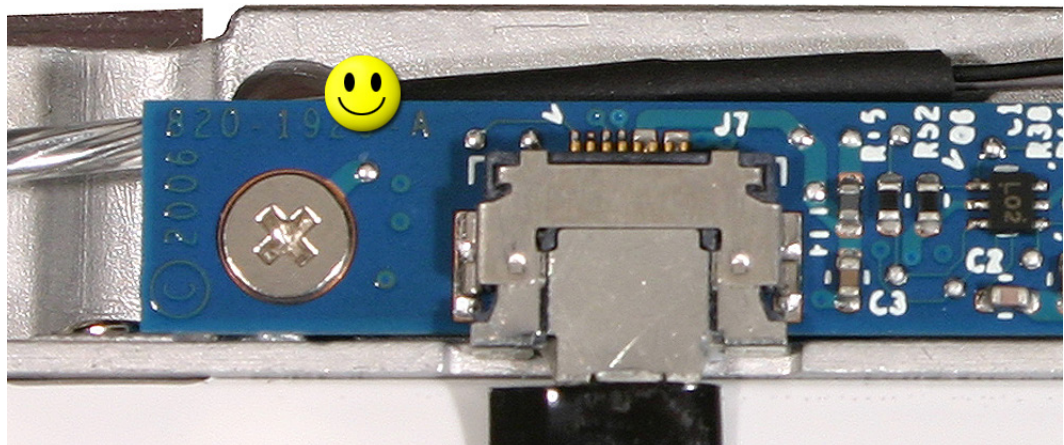
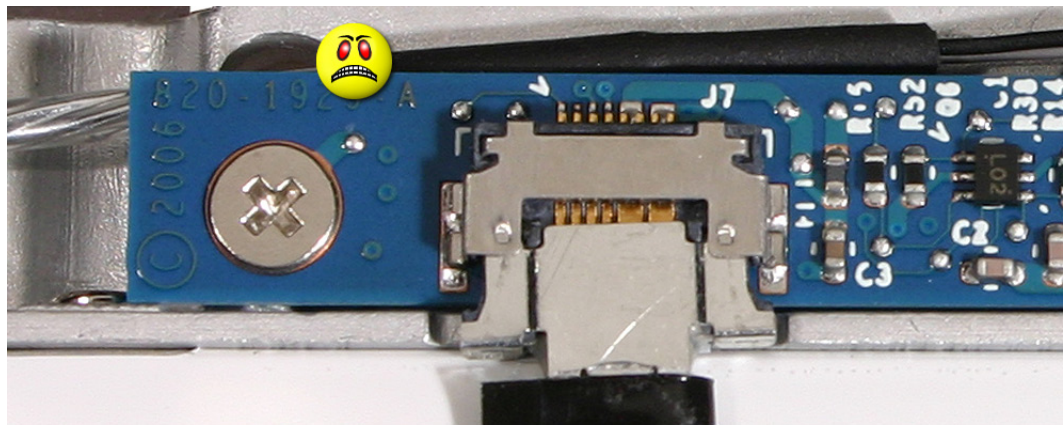

5. Remove the LVDS cable from the panel, and unwrap the black tape that secures the cable to the microphone cable.

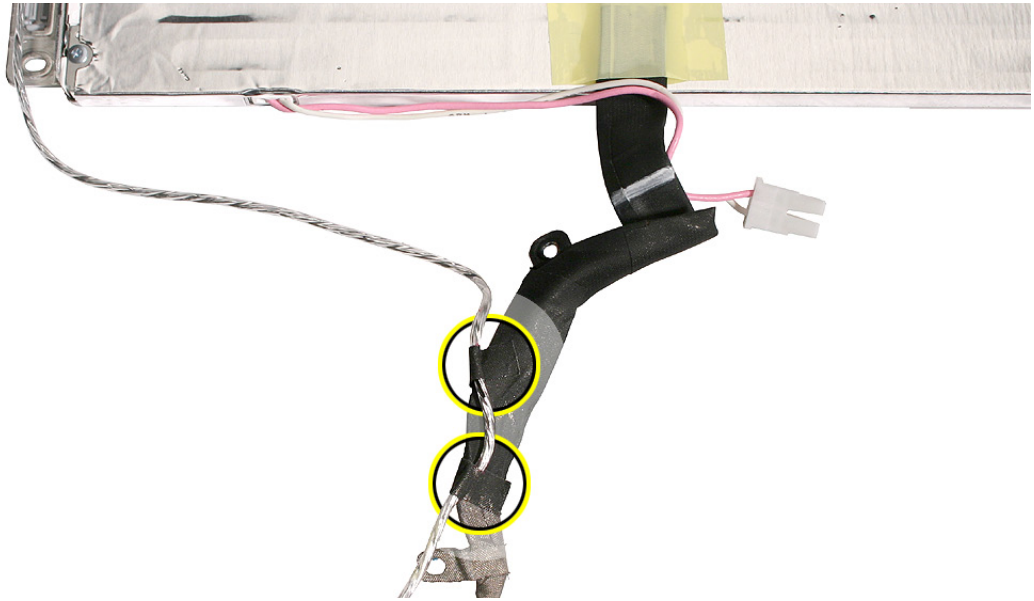

**Replacement Note:** Whenever the microphone cable is to be separated from the LVDS cable, use a permanent marking pen to mark the microphone cable. Marking the cable where the strips of conductive tape overlap the microphone cable provides a guide for reassembly.

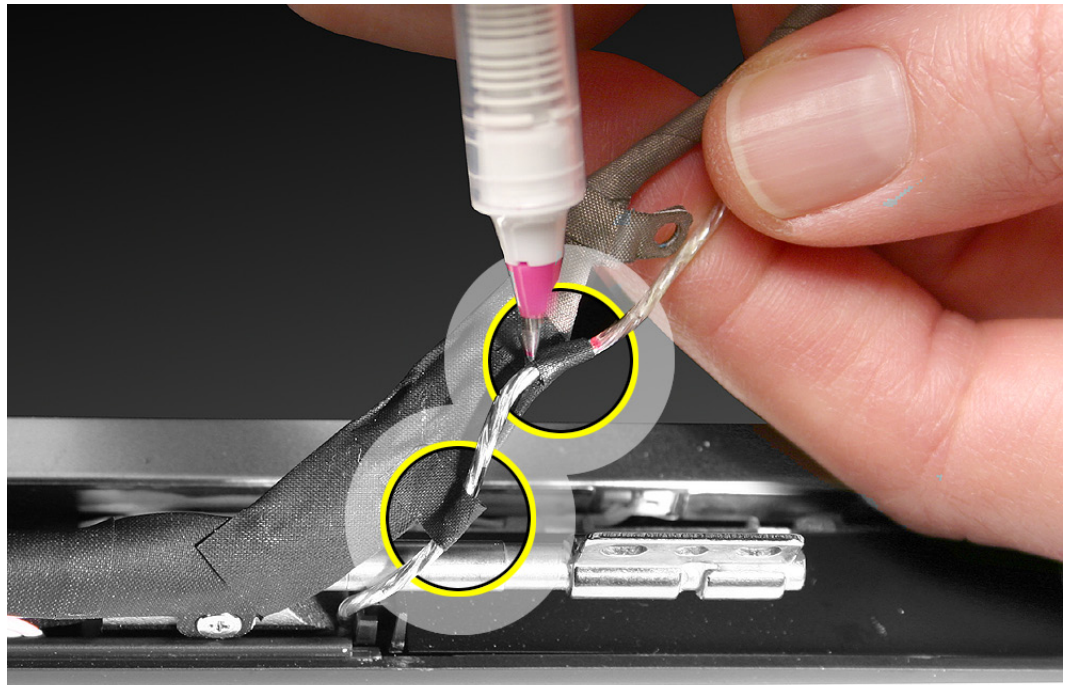

- 
6. Install the replacement LVDS cable with USB line, and reassemble and test the computer.



**Replacement Note:** Make sure the LVDS cable is correctly matched with its corresponding LCD panel.



# Microphone Cable

## Tools

- Soft cloth
- ESD wrist strap and mat
- Magnetic Phillips #0 screwdriver
- Black stick (Apple part no. 922-5065) or other nonconductive nylon or plastic flatblade tool
- Permanent marking, felt-tip pen

## Preliminary Steps

Before you begin, remove

- [Battery](#)
- [RAM door](#)
- [Top case with keyboard](#)
- [Optical drive](#)
- [Clutch block, left](#)
- [Clutch block, right](#)
- [Display module](#)
- [Display bezel](#)
- [Clutch cover](#)
- [Spacers at bezel scoops](#)
- [Bezel scoops](#)
- [Inverter board](#)
- [LCD panel assembly](#)

---

## Part Location

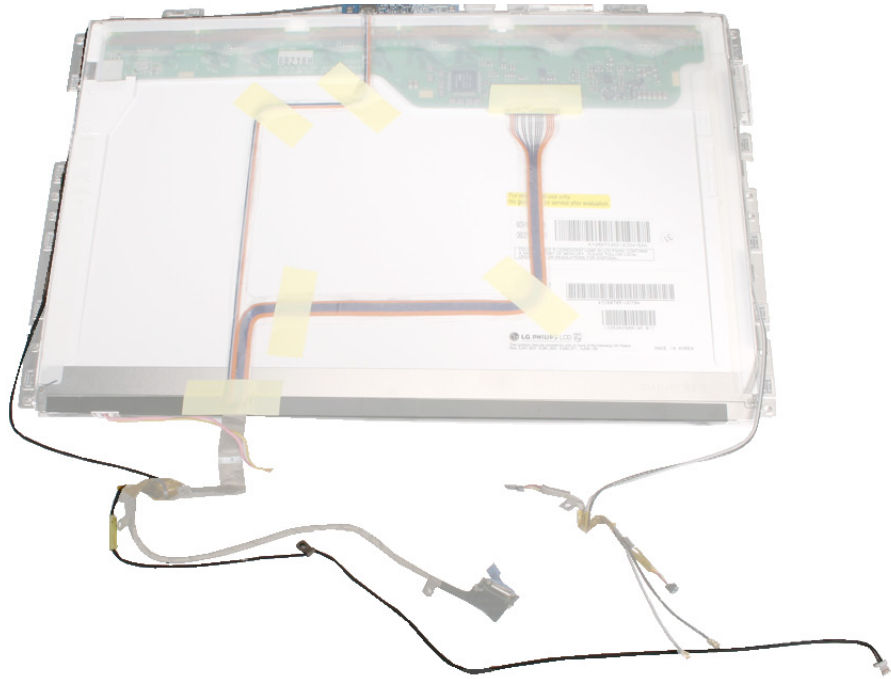

## Procedure

1. Note the routing of the microphone cable as it runs along the right edge of the LCD panel.

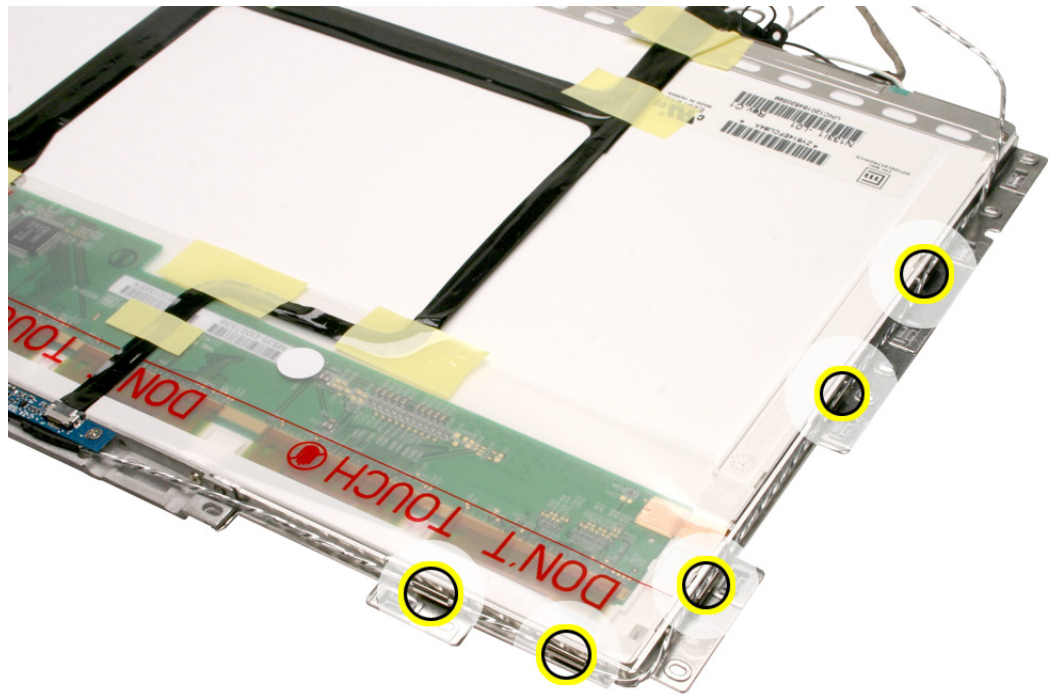

2. Pull up the cable from the routing tabs.

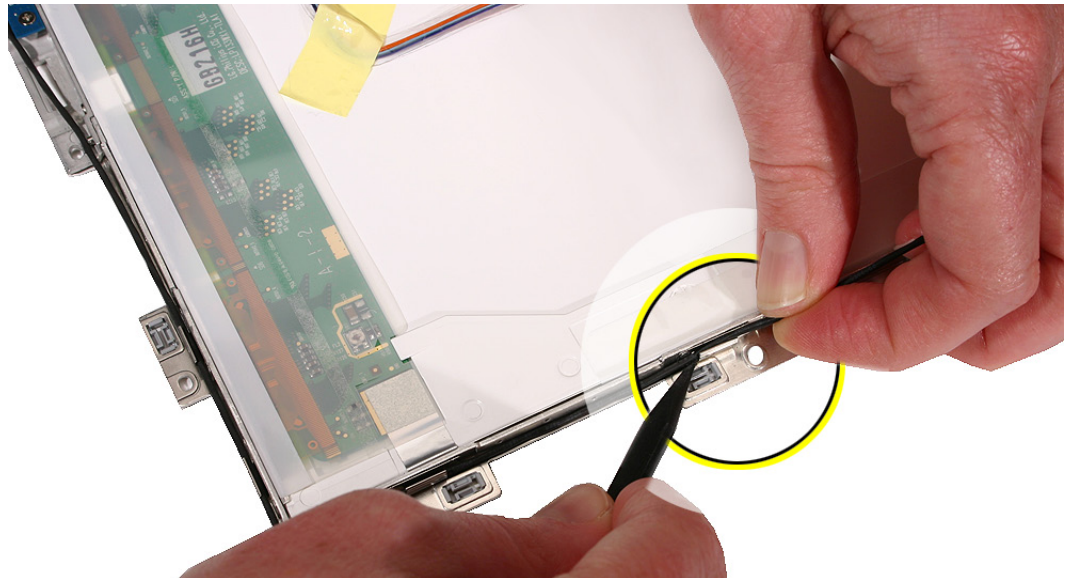

3. Peel up the single strip of tape that holds the microphone cable in place at the camera bracket.

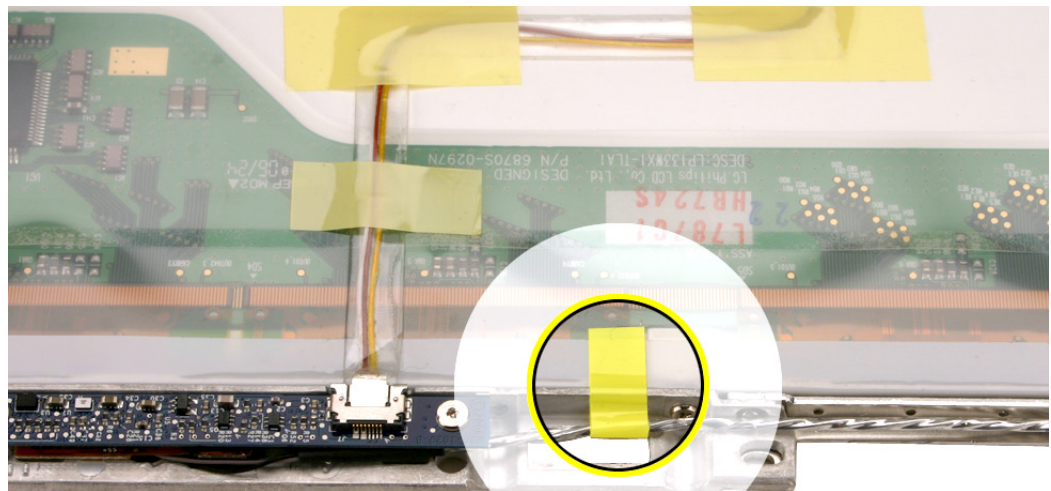

**Replacement Note:** Be sure to install a replacement strip of tape to hold the microphone cable in place and keep the cable away from areas where it could be pinched when the panel is reinstalled. Make sure the tape wraps around to the front of the camera bracket.



4. Remove the two 3-mm long screws from the camera board.

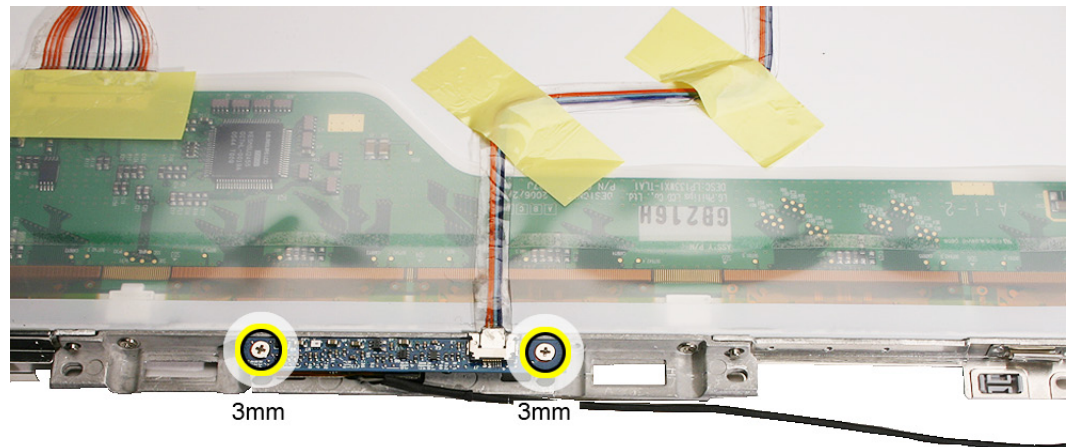

5. Without straining the camera board cable, carefully tilt up the camera board to access the microphone that is fitted into the opening in the camera bracket.

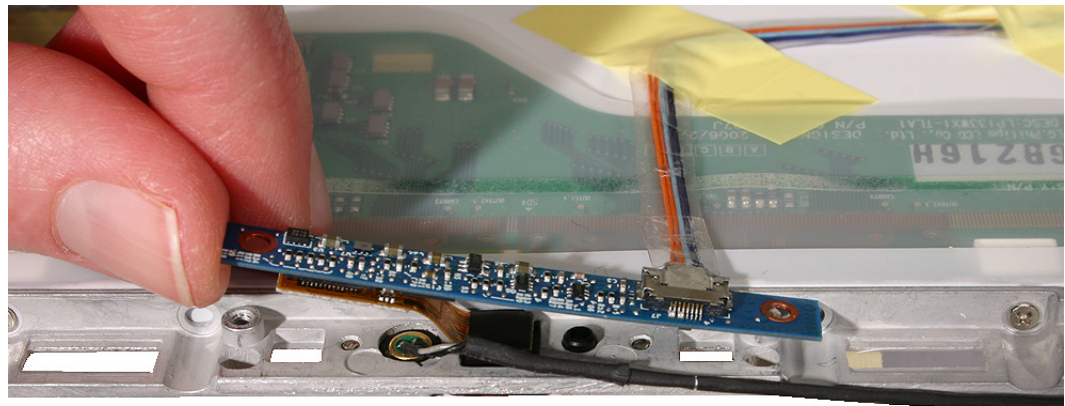

6. Use a black stick to pull up the microphone from the gasket.

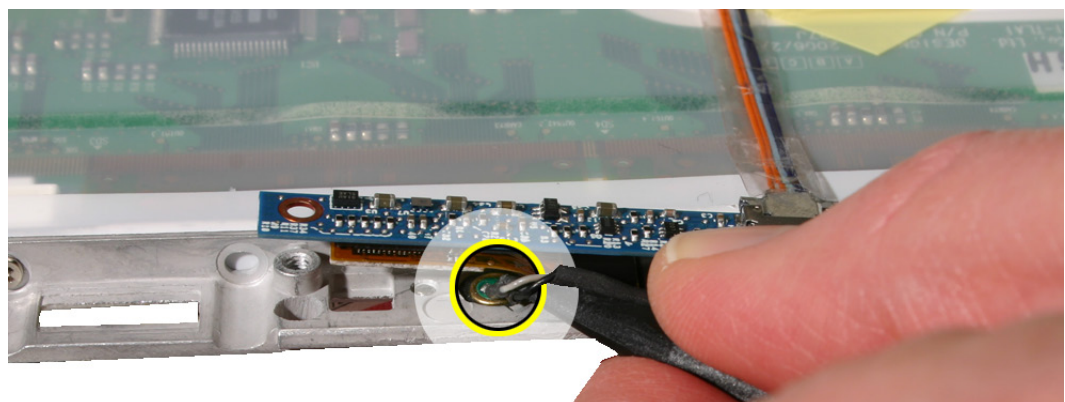

---

**Replacement Note:** Install the microphone in the gasket and use a black stick to press it down so it is level with the edge of the gasket.

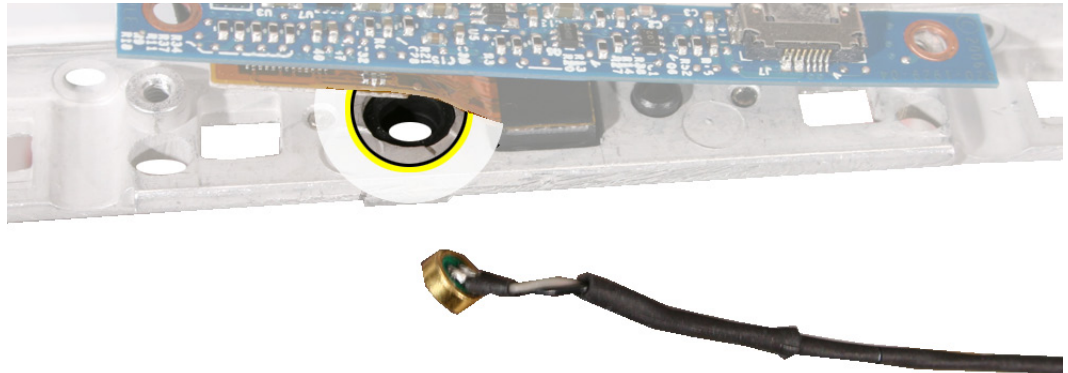

7. Unwrap the black tape that secures the microphone cable with the LVDS cable.

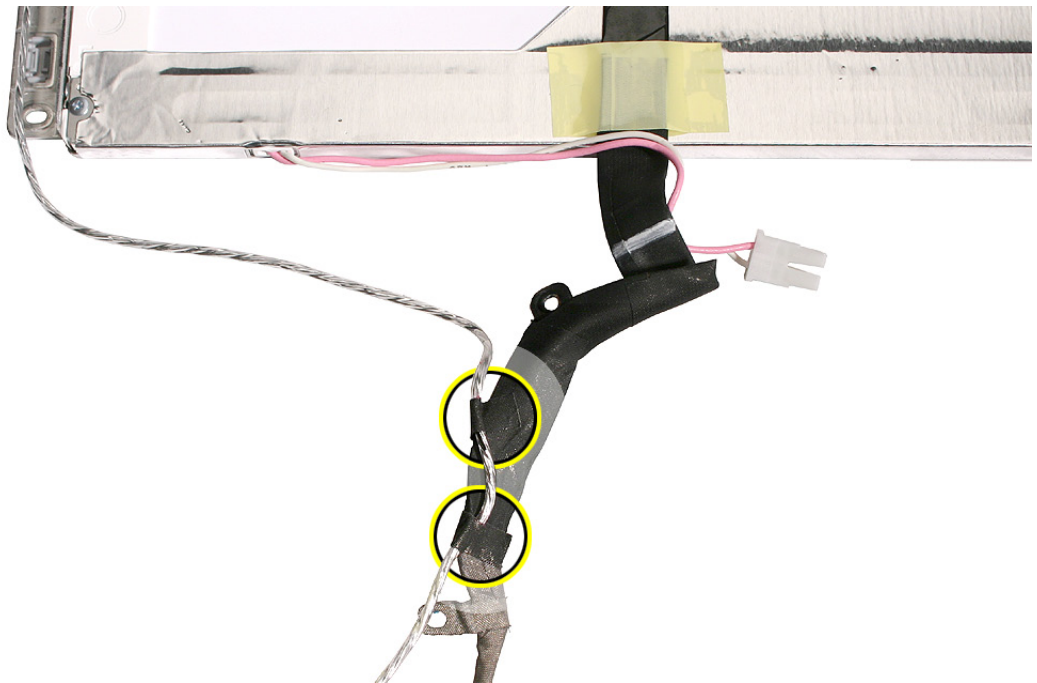

- 
8. **Replacement Note:** Whenever the microphone cable is to be separated from the LVDS cable, use a permanent marking pen to mark the microphone cable. Marking the cable where the strips of conductive tape overlap the microphone cable provides a guide for reassembly.

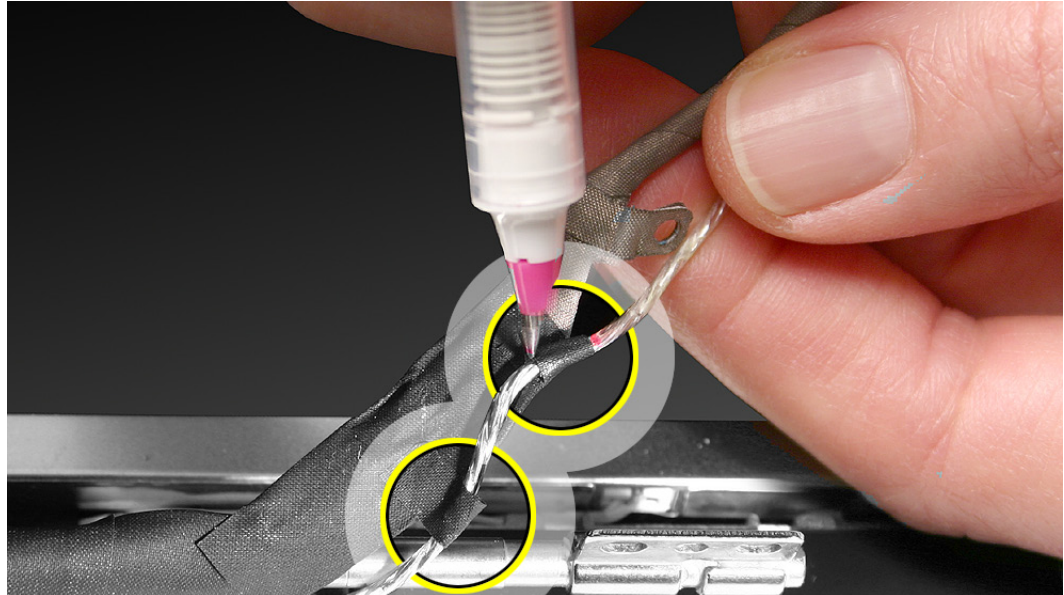

9. Install the replacement microphone cable, and reassemble and test the computer.

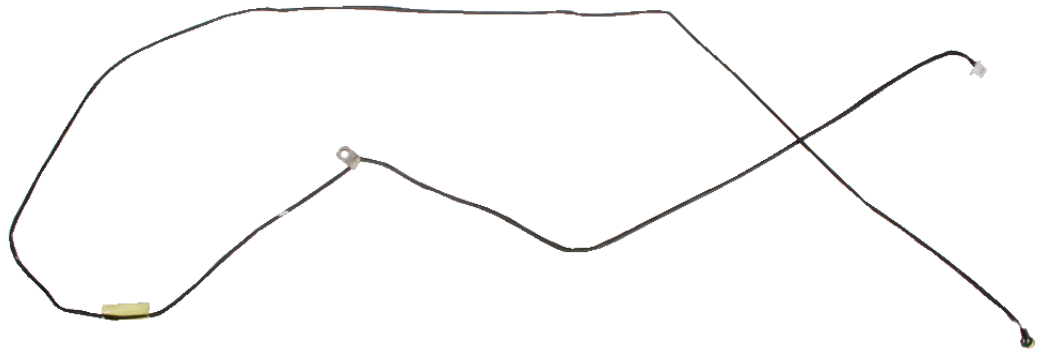

---

**Important:** Where the microphone cable exits the display rear housing, the microphone cable must be pulled taut within the cable bundle exiting the display. If it's too loose or too tight, it could get pinched during display reassembly.





# Inverter Board

## Tools

- Soft cloth
- ESD wrist strap and mat
- Black stick (Apple part no. 922-5065) or other nonconductive nylon or plastic flatblade tool

## Preliminary Steps

Before you begin, remove

- [Battery](#)
- [RAM door](#)
- [Top case with keyboard](#)
- [Optical drive](#)
- [Clutch block, left](#)
- [Clutch block, right](#)
- [Display module](#)
- [Display bezel](#)
- [Clutch cover](#)

## Part Location



---

## Procedure

**Caution:** During this procedure, do not press on the flat area of the board or on its components. Handle the board by the edges only.

1. Using a black stick or your fingers, disconnect the inverter cable from the left end of the board.

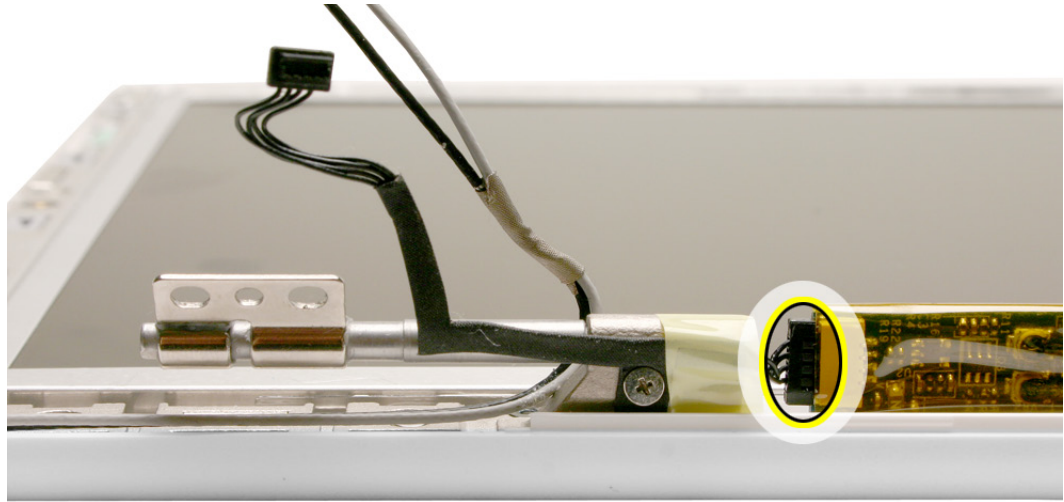

2. Disconnect the LCD panel cable from the right end of the board.

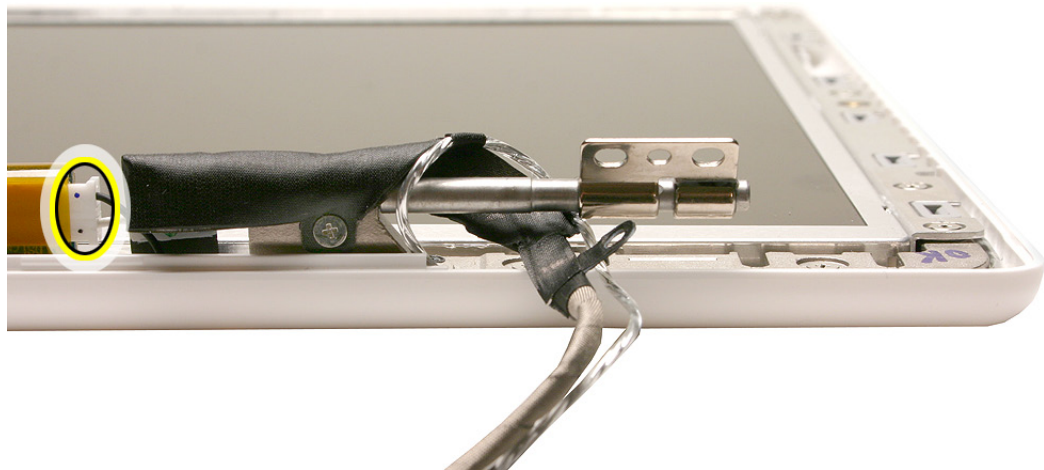

3. Holding the board by the ends, lift out the inverter board from the slot in the display rear housing.

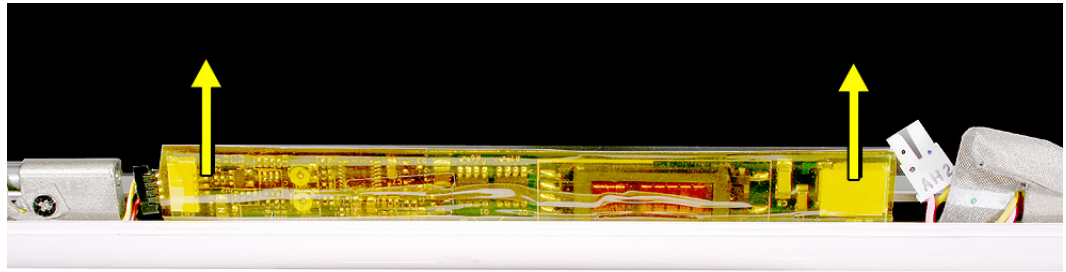

4. Install the replacement inverter board, and reassemble and test the computer.

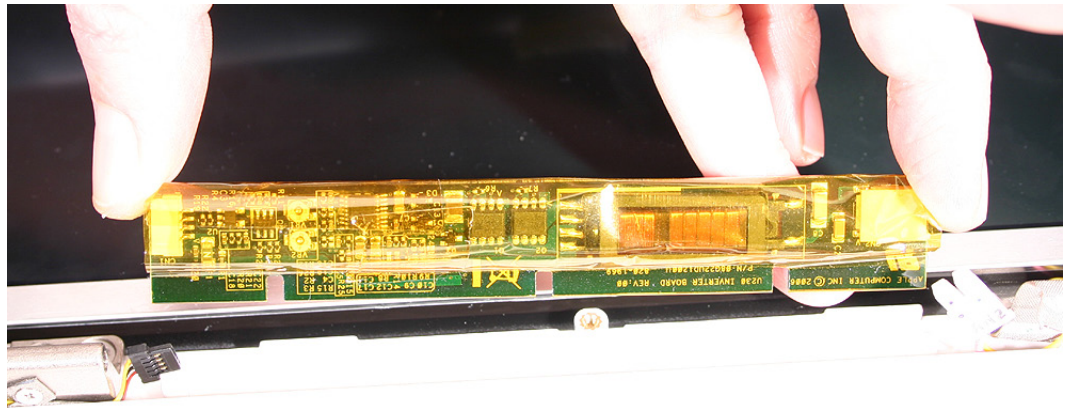



# Inverter Cable

## Tools

- Soft cloth
- ESD wrist strap and mat
- Black stick (Apple part no. 922-5065) or other nonconductive nylon or plastic flatblade tool

## Preliminary Steps

Before you begin, remove

- [Battery](#)
- [RAM door](#)
- [Top case with keyboard](#)
- [Optical drive](#)
- [Clutch block, left](#)
- [Clutch block, right](#)
- [Display module](#)
- [Display bezel](#)
- [Clutch cover](#)

## Part Location

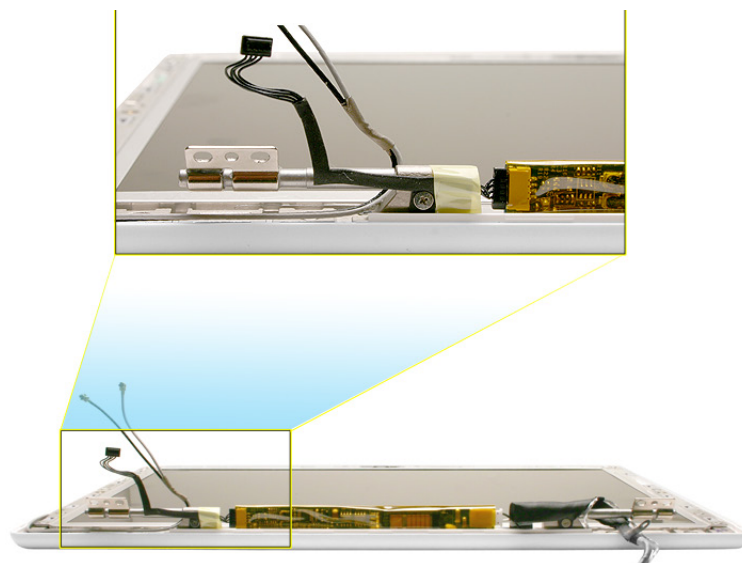

---

## Procedure

1. With the display assembly resting on a clean, soft cloth, note the position of the inverter cable in relation to the left clutch barrel.
2. Remove the tape from the left clutch barrel.

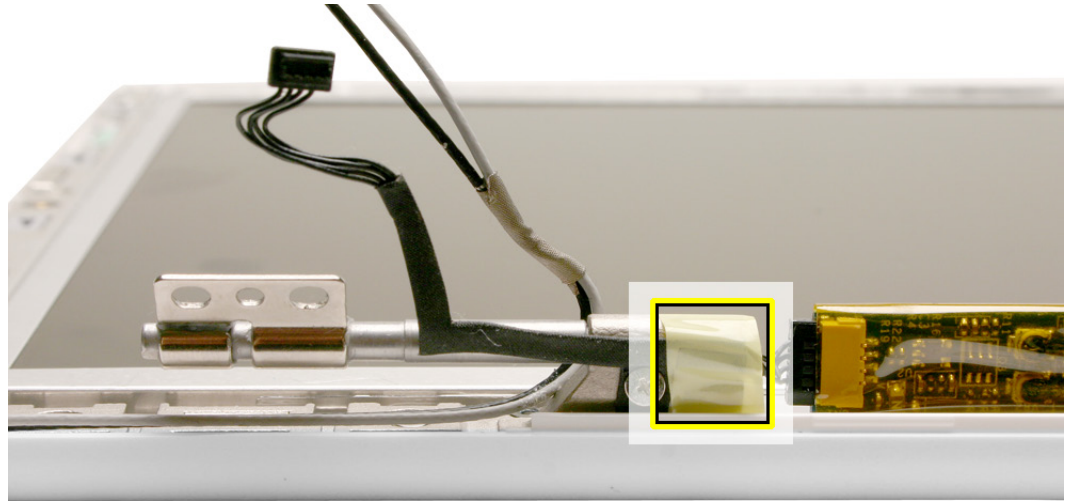

3. Remove the 3-mm long ground screw, and disconnect the inverter cable from the left end of the inverter board.

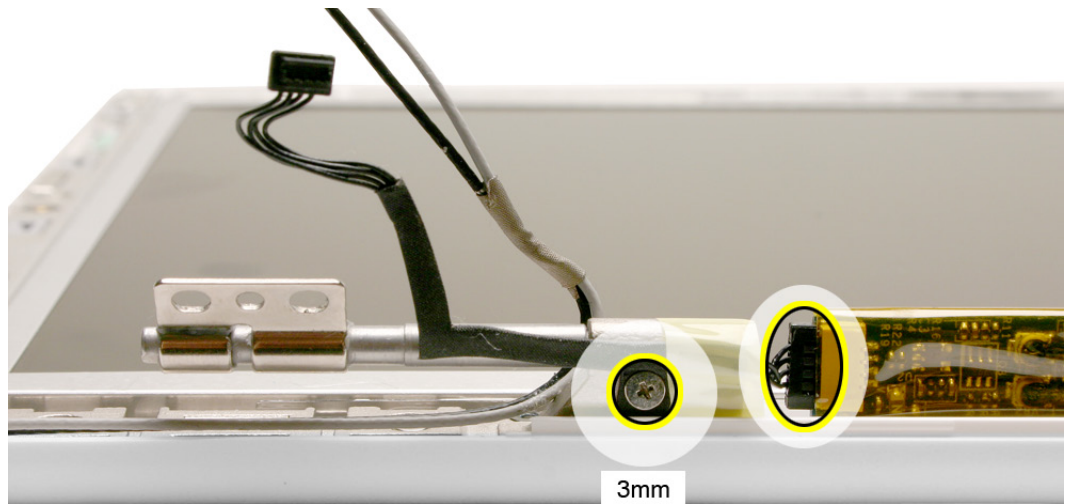

- 
4. Remove the inverter cable from the display assembly.



5. Replace the inverter cable, and reassemble and test the computer

**Replacement Note:** Apply the tape where shown to secure the inverter cable to the left hinge.

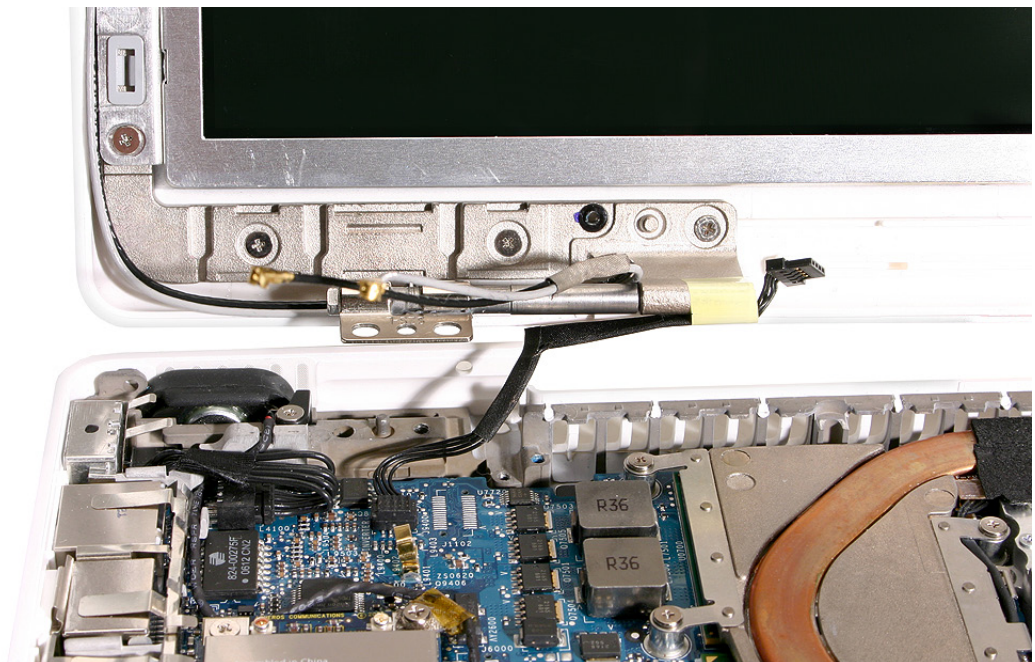



# Display Hinges, Left and Right

## Tools

- Soft cloth
- Magnetic Phillips #0 screwdriver
- Black stick (Apple part no. 922-5065) or other nonconductive nylon or plastic flatblade tool

## Preliminary Steps

Before you begin, remove

- [Battery](#)
- [RAM door](#)
- [Top case with keyboard](#)
- [Optical drive](#)
- [Clutch block, left](#)
- [Clutch block, right](#)
- [Display module](#)
- [Display bezel](#)
- [Clutch cover](#)
- [Spacers at bezel scoops](#)
- [Bezel scoops](#)
- [Inverter board](#)
- [LCD panel assembly](#)

## Part Location

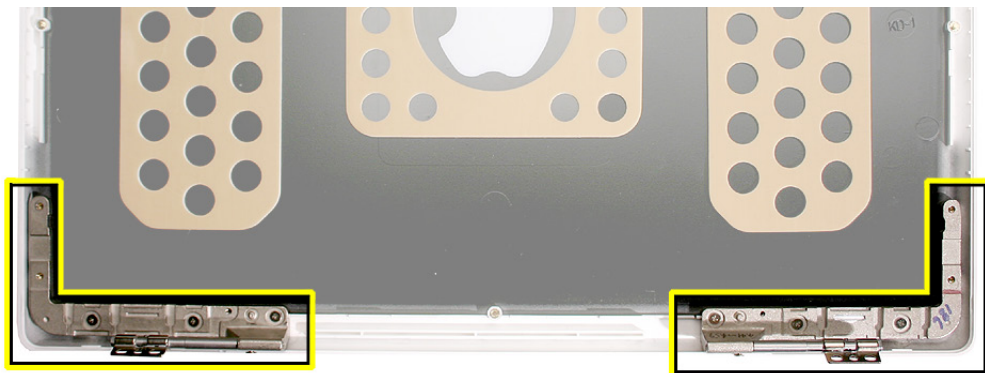

## Procedure

1. With the display housing on a soft cloth, remove the three identical 4-mm long screws along the lower “arm” of each hinge.

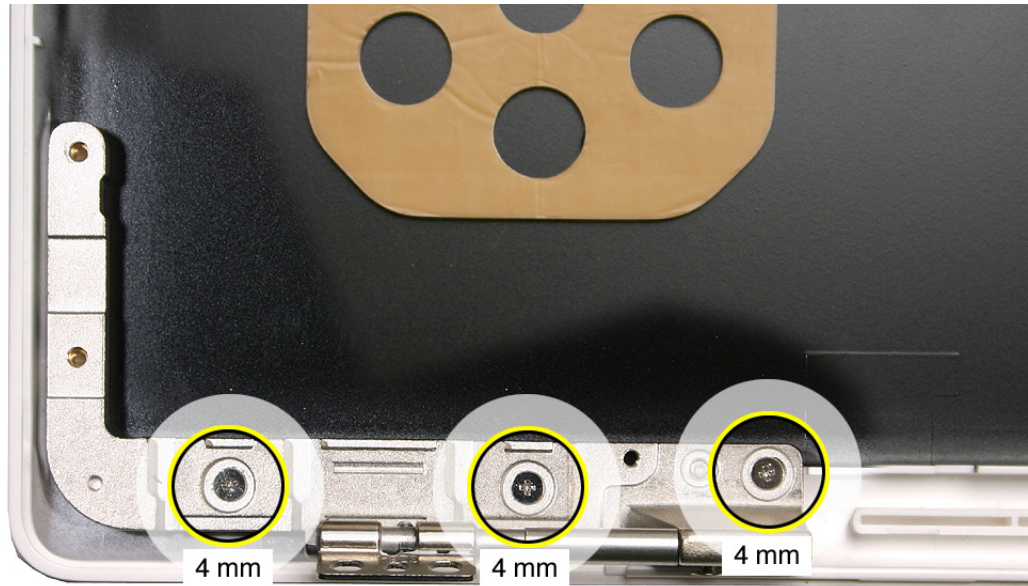

2. Use a black stick to carefully pry up each hinge from the double-sided tape holding it to the display rear housing.

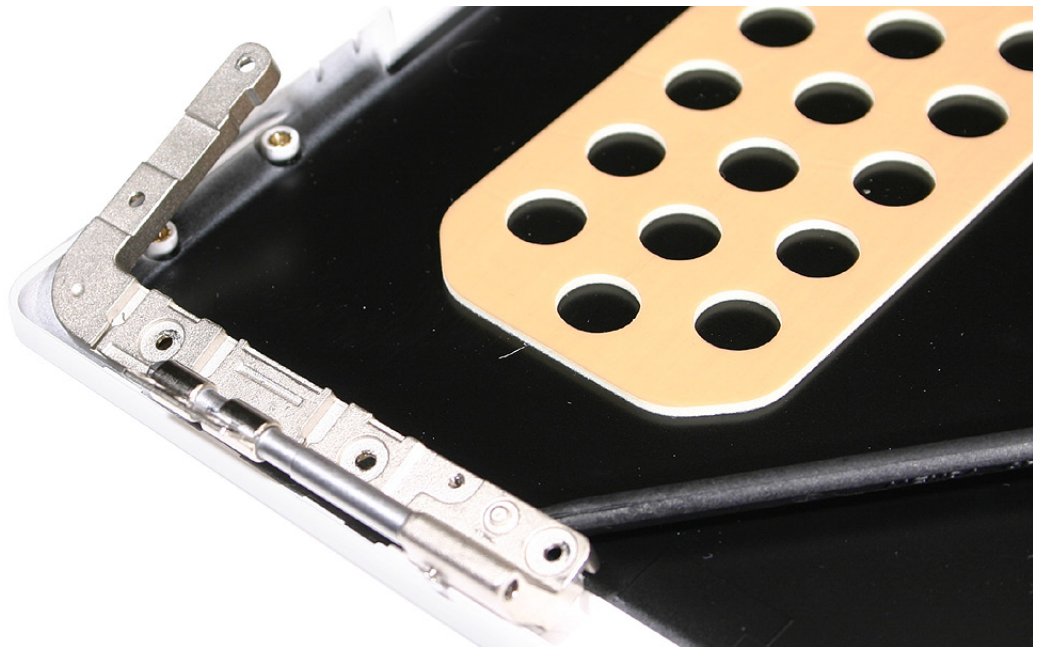

---

**Replacement Note:** When installing new hinges, peel off the adhesive backing and align the hinges over the screw standoffs in the display rear housing.

3. Install the replacement display hinges, and reassemble and test the computer.

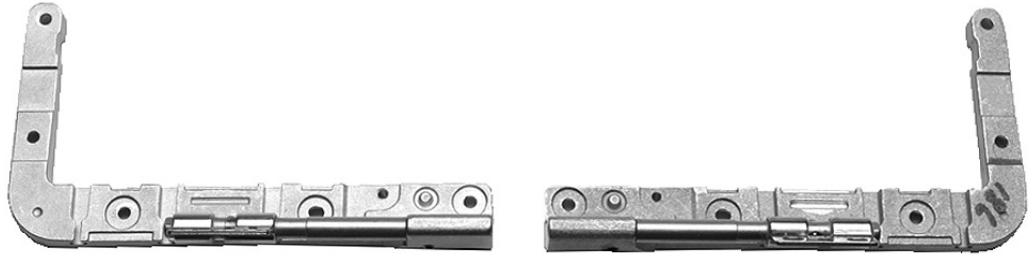



## Bezel Brace, Left

The L-shaped bezel brace attaches to the left side of the LCD panel and includes integral tabs for the AirPort antenna cable routing.

### Tools

With the preliminary steps completed, no tools are required for this procedure.

### Preliminary Steps

Before you begin, remove

- [Battery](#)
- [RAM door](#)
- [Top case with keyboard](#)
- [Optical drive](#)
- [Clutch block, left](#)
- [Clutch block, right](#)
- [Display module](#)
- [Display bezel](#)
- [Clutch cover](#)
- [Spacers at bezel scoops](#)
- [Bezel scoops](#)
- [Inverter board](#)
- [LCD panel assembly](#)
- [Antenna receptors and cables, top and left](#)

---

## Part Location



## Procedure

1. With the wireless antenna receptors removed, the left bezel brace is loose from the LCD panel assembly.
2. Follow the replacement instructions in “Antenna Receptors and Cables” to attach the cables before installing the replacement left bezel brace. Then reassemble and test the computer.



## Bezel Brace, Right

The L-shaped bezel brace attaches to the right side of the LCD panel and includes integral tabs for the microphone cable routing.

### Tools

- Soft cloth
- ESD wrist strap and mat
- Magnetic Phillips #0 screwdriver
- Black stick (Apple probe tool, part no. 922-5065) or other nonconductive nylon or plastic flatblade tool
- Access card (Apple part no. 922-7172)

### Preliminary Steps

Before you begin, remove

- [Battery](#)
- [RAM door](#)
- [Top case with keyboard](#)
- [Optical drive](#)
- [Clutch block, left](#)
- [Clutch block, right](#)
- [Display module](#)
- [Display bezel](#)
- [Clutch cover](#)
- [Spacers at bezel scoops](#)
- [Bezel scoops](#)
- [Inverter board](#)
- [LCD panel assembly](#)
- [Antenna receptor and cable, right \(Late 2007 model only\)](#)

## Part Location



## Procedure

**Caution:** Do not press on the LCD panel during this procedure. Pressing on the panel could damage the internal circuitry.

1. Note how the microphone cable is routed through the tabs on the right bezel brace.

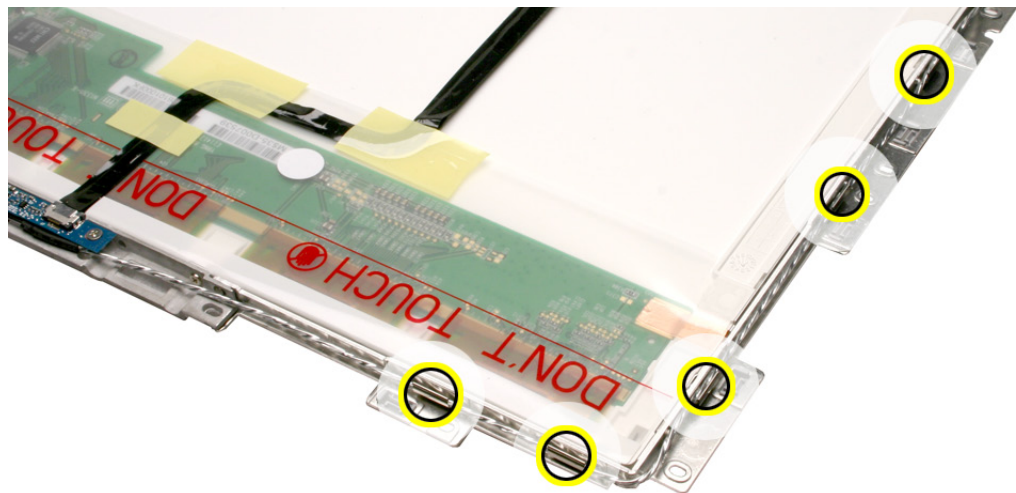

- Without straining the microphone cable, use a black stick to loosen it from the tabs.
- Remove the three identical 3-mm long screws (these can be identified by the small screw head) from the right side of the LCD panel.

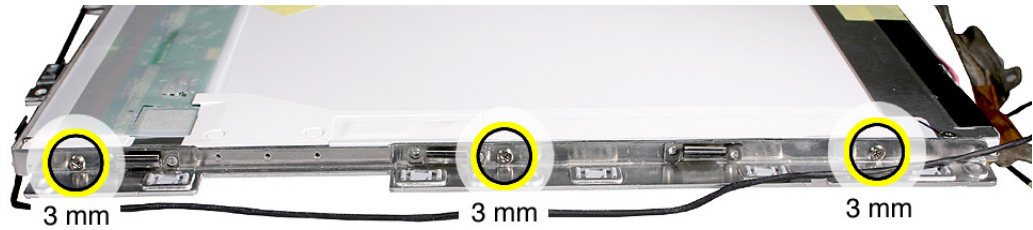

- Remove the 3-mm long camera bracket screw.

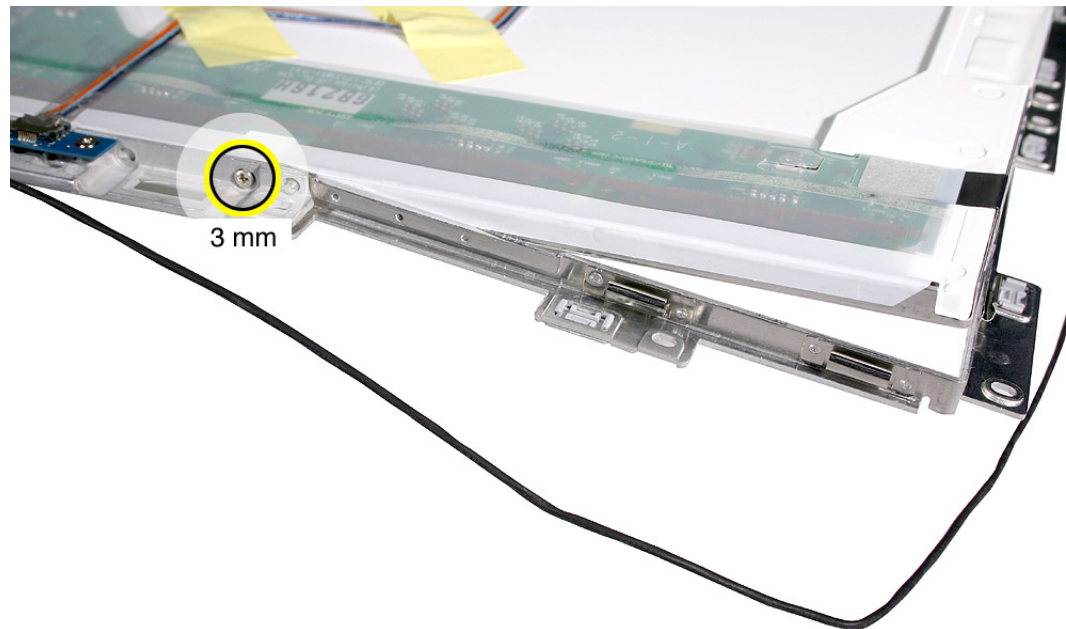

- Without straining the USB flex cable, tilt up the camera bracket and remove the right bezel brace from the LCD panel assembly.

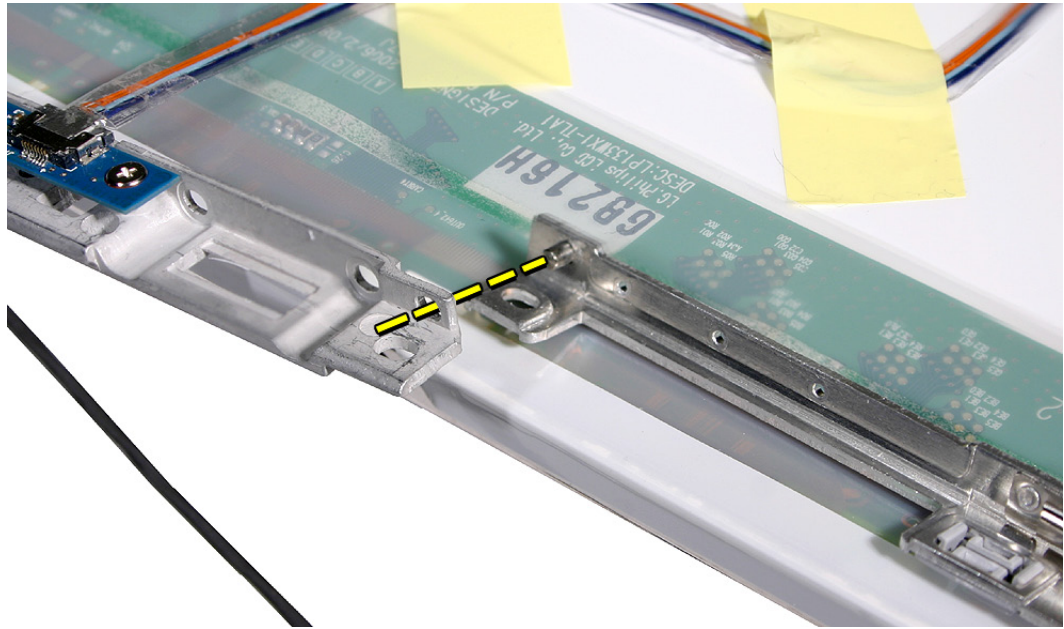

- Install the replacement right bezel brace, and reassemble and test the computer.





# Sleep Magnet

## Tools

- Soft cloth
- Black stick (Apple probe tool, part no. 922-5065) or other nonconductive nylon or plastic flatblade tool
- Jeweler's flatblade screwdriver

## Preliminary Steps

Before you begin, remove

- [Battery](#)
- [RAM door](#)
- [Top case with keyboard](#)
- [Optical drive](#)
- [Clutch block, left](#)
- [Clutch block, right](#)
- [Display module](#)
- [Display bezel](#)
- [Clutch cover](#)
- [Spacers at bezel scoops](#)
- [Bezel scoops](#)
- [Inverter board](#)
- [LCD panel assembly](#)

## Part Location

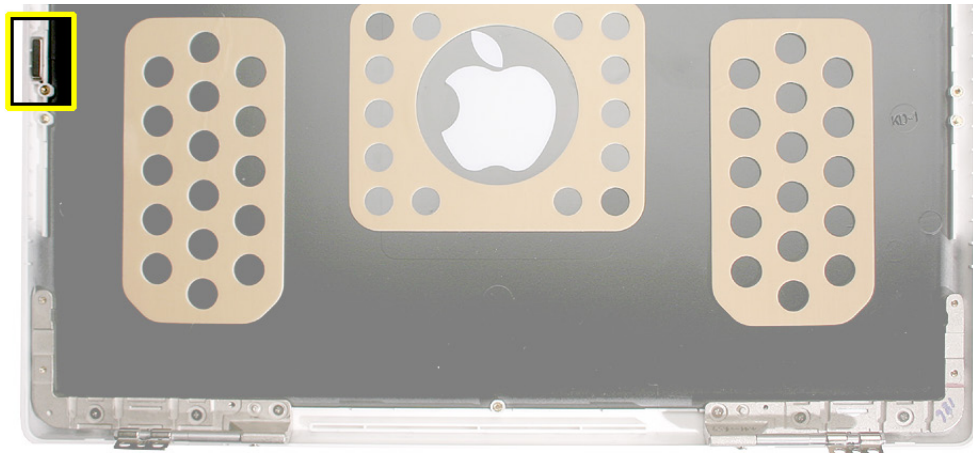

## Procedure

1. With the display rear housing on a soft cloth, note the position of the sleep magnet recessed in the left side of the housing.
2. Using a black stick or a jeweler's flatblade screwdriver, insert the tip of the black stick or screwdriver in the tiny opening under the magnet, and pry up the sleep magnet from the left side of the display rear housing.



**Replacement Note:** Notice the beveled shape of the magnet. Position the magnet in the display rear housing so that the wider base of the magnet sits in the opening. Make sure the magnet is securely in place before reassembling the display module.

- 
3. Install the replacement sleep magnet, and reassemble and test the computer.

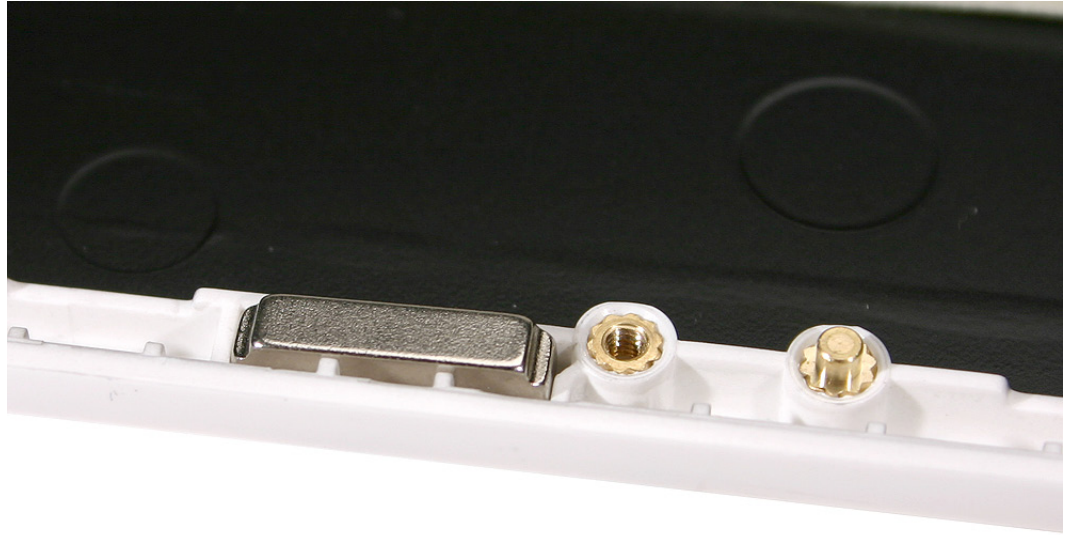



# Display Magnet Pairs

## Tools

- Soft cloth
- Black stick (Apple probe tool, part no. 922-5065) or other nonconductive nylon or plastic flatblade tool
- Jeweler's flatblade screwdriver

## Preliminary Steps

Before you begin, remove

- [Battery](#)
- [RAM door](#)
- [Top case with keyboard](#)
- [Optical drive](#)
- [Clutch block, left](#)
- [Clutch block, right](#)
- [Display module](#)
- [Display bezel](#)
- [Clutch cover](#)
- [Spacers at bezel scoops](#)
- [Bezel scoops](#)
- [Inverter board](#)
- [LCD panel assembly](#)

---

## Part Location



## Procedure

1. With the display rear housing on a soft cloth, note the position of the magnet pairs recessed in the top corners of the display rear housing.
2. If the magnet pairs are tight in the slots, use a black stick or a jeweler's flatblade screwdriver to remove the magnet pairs from the display rear housing.

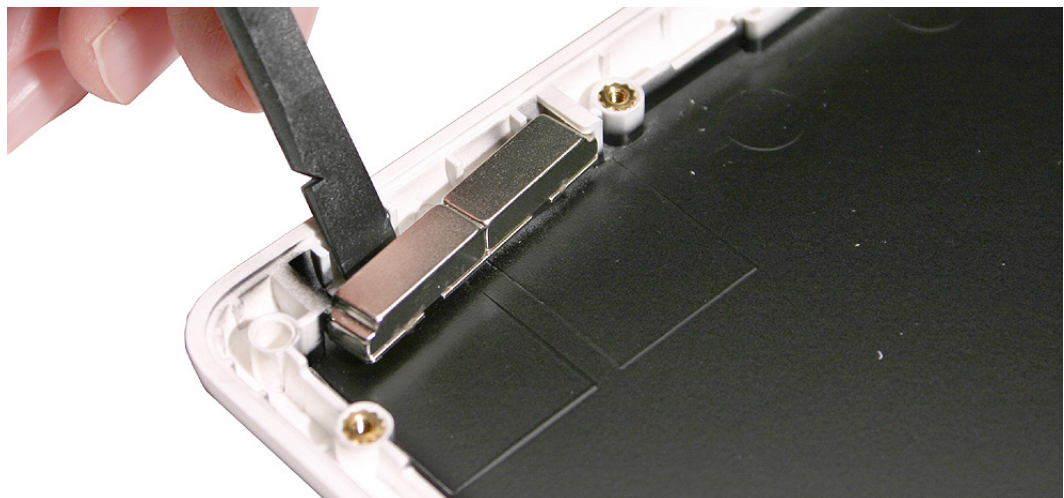

- 
3. Install the replacement display magnet pairs, and reassemble and test the computer.

**Replacement Note:** Make sure a metal shunt is attached and correctly aligned to the base of each magnet pair. The magnet pairs are interchangeable between the left and right side of the display rear housing.

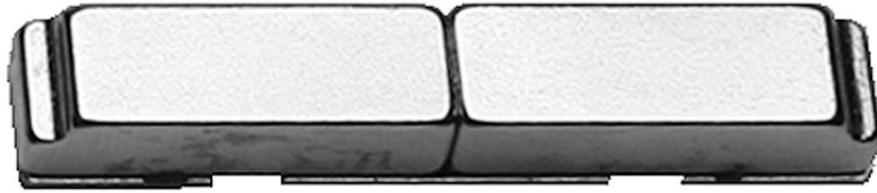

Slide the replacement magnet pairs into the top recessed areas of the display rear housing.

**Replacement Note:** In addition to the magnet pairs, check that the sleep magnet is also installed in the rear housing, left side.

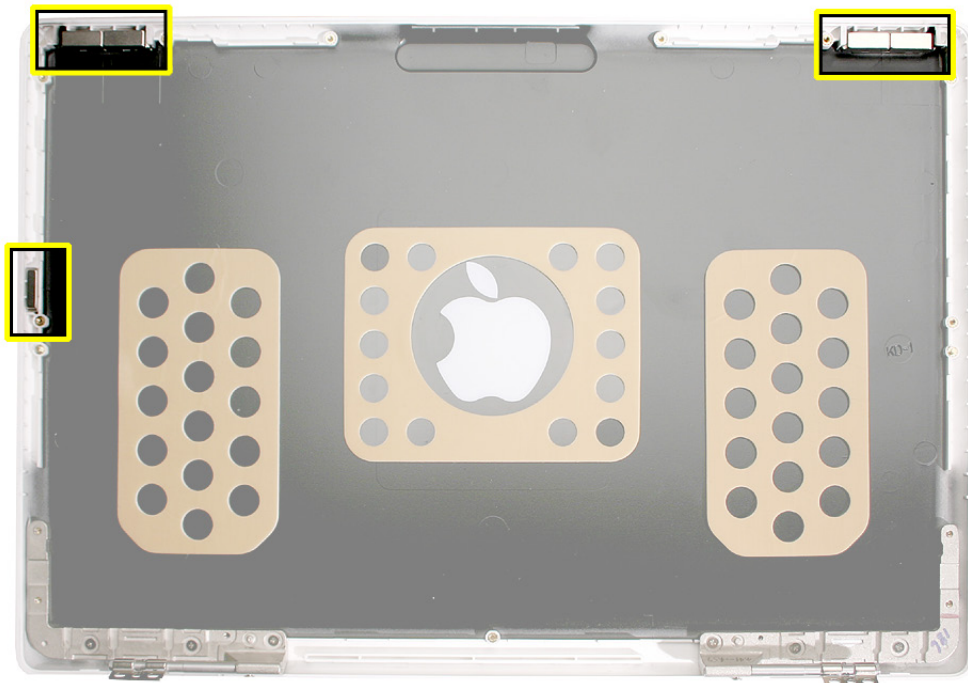

---

**Replacement Note:** When installing the LCD panel assembly, the magnets may be drawn to the metal frame and become loose. Make sure they are fitted back in the rear housing before tightening any screws on the LCD panel assembly.

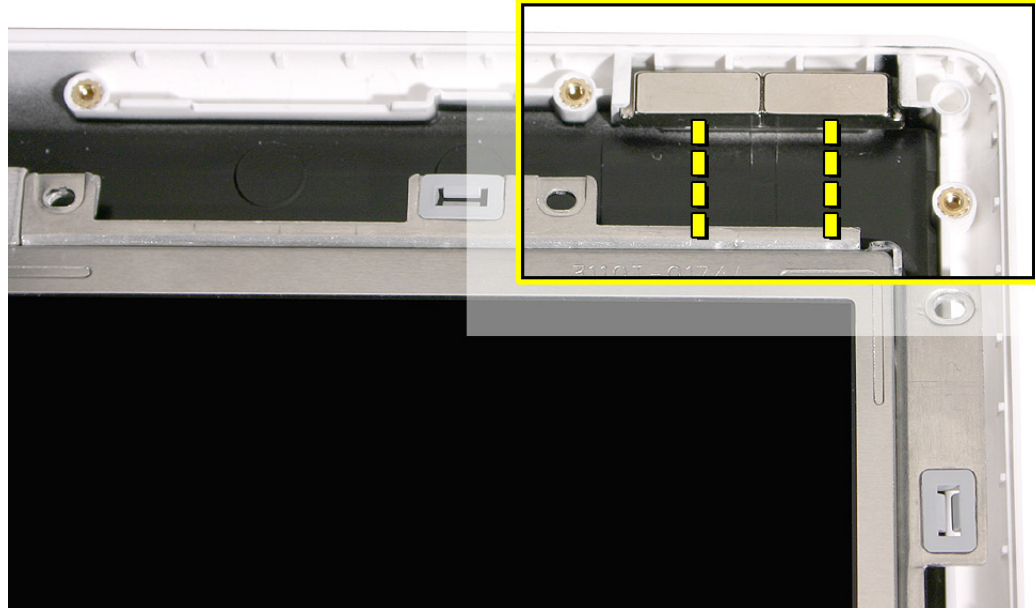



# Display Rear Housing

## Tools

- Soft cloth

## Preliminary Steps

Before you begin, remove

- [Battery](#)
- [RAM door](#)
- [Top case with keyboard](#)
- [Optical drive](#)
- [Clutch block, left](#)
- [Clutch block, right](#)
- [Display module](#)
- [Display bezel](#)
- [Clutch cover](#)
- [Spacers at bezel scoops](#)
- [Bezel scoops](#)
- [Inverter board](#)
- [LCD panel assembly](#)
- [Display hinges, left and right](#)
- [Sleep magnet](#)
- [Display magnet pairs, left and right](#)

---

## Part Location

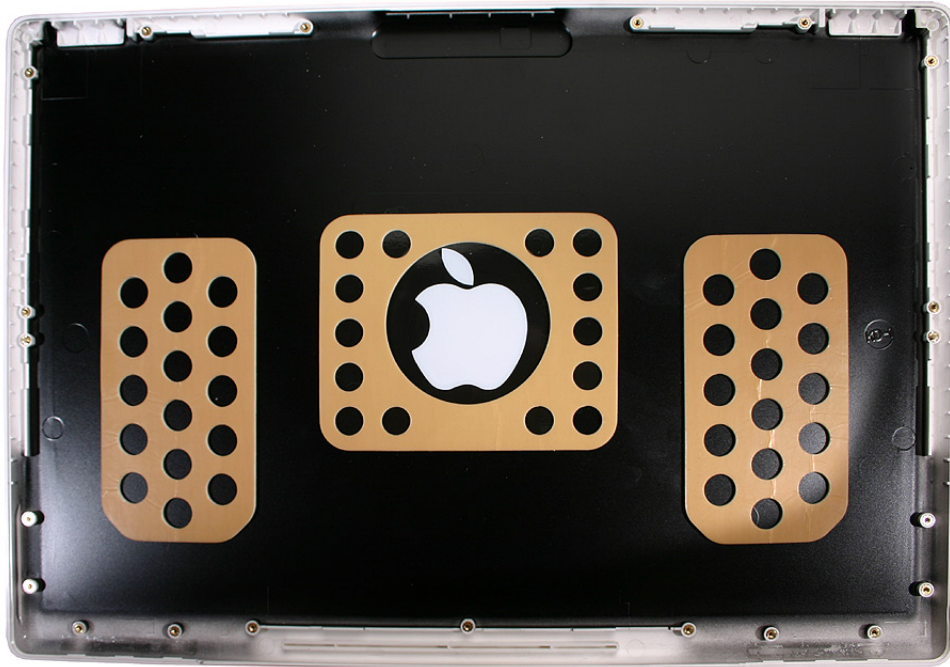

## Procedure

1. When all of the parts listed in the preliminary steps are removed, the remaining part is the display rear housing.



---

**Replacement Note:** When reassembling the LCD panel assembly in the display rear housing, make sure the magnet pairs and sleep magnet are secured in place.

2. Reassemble and test the computer.

**Replacement Note:** The display rear housing comes with the pre-installed Apple logo, sponge pads, and corner brackets in the upper left and right corners.

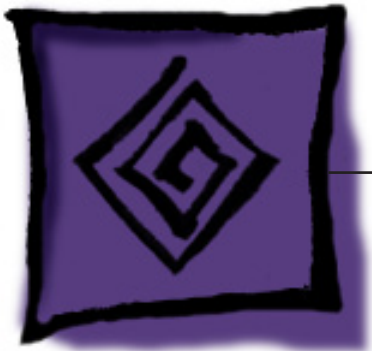

Troubleshooting  
MacBook (13-inch, Early 2009)



# General Information

## Introduction

This section covers general troubleshooting tips, firmware updates, and software troubleshooting. For more specific symptoms, refer to the Symptom Charts section in this chapter.

As a reminder, the general troubleshooting steps are:

1. Gather information
2. Verify the problem
3. Try quick fixes
4. Run diagnostics
5. Try systematic fault isolation
6. Research
7. Escalate
8. Repair or replace
9. Verify the repair
10. Inform the user
11. Complete administrative tasks

**Note:** If you are not familiar with the [Apple General Troubleshooting Flowchart](#), see the self-paced course [General Troubleshooting Theory](#).

## Troubleshooting Aids and Tips

### Resetting the System Management Controller (SMC)

To reset power management via the SMC chip:

1. If the computer is on, turn it off.
2. Disconnect the power adapter and remove the main battery.
3. Hold the power button down for five seconds, then release.
4. Install the main battery and connect the power adapter.
5. Press the power button to restart the computer.

---

## System Reset Pads on Logic Board

In instances where troubleshooting requires startup with the top case removed, there are two pads on the logic board that can be shorted with a small flat blade screwdriver to start up the system. These pads are located between the processor and the right memory slot. The two pads are marked with the abbreviation “SMC\_RST,” as shown:

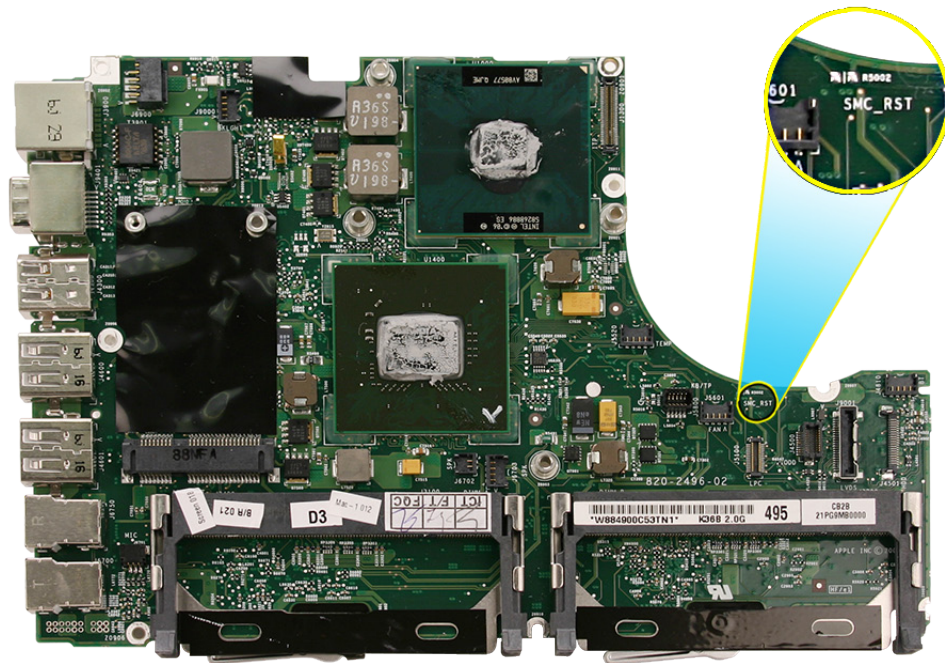

### Display off and sleep LED on

When the system is running but no video is present (for example, briefly upon boot, or when the energy saver dims the LCD but does not put the system to sleep), the sleep LED will light up continuously to avoid the perception that the system is shut down. It is possible, however, that this signal may fail if the system has crashed. You can use the following test to see if power is present to an apparently “off” system.

### System powered test using Caps lock LED

Even when the system is “off” (e.g., no sleep light, no hard drive access, no fan and a dark screen), in rare cases the logic board may still be running, drawing power and generating heat.

**Warning:** In this situation, if the computer is placed in an enclosed environment like a carrying bag the computer can overheat.

You can potentially verify this situation by pressing the Caps Lock key. If the LED glows, the

---

power manager is actively running on the logic board. If pressing the Caps Lock key or other methods of waking up the machine have failed, including closing the lid to put it to sleep and reopening it to wake it, hold the power button down for six seconds to force a shut down of the computer. Restart the system to check that it boots up normally.

**Note:** Given that the keyboard in a MacBook or MacBook Pro is a USB device, it may not respond when the operating system has crashed. Thus, despite the fact that the caps lock LED does not light up, the computer may still be drawing power. If in doubt, hold the power button down for six seconds to force a shut down of the computer.

## MacBook Firmware Updates

Firmware is the name given to software that is written into memory circuits such as flash memory, that will hold the software code indefinitely, even when power is removed from the hardware. Firmware on Intel Mac computers is designed to be updated if necessary through a software update.

EFI and SMC firmware is stored on the MacBook logic board. EFI firmware updates update the Boot ROM, and SMC Updates update the System Management Controller firmware. The SMC manages fans and other environmental parameters that are independent of the Boot ROM.

Firmware symptoms can be easily mistaken for hardware issues (e.g. overheating issues, fan noise issues, etc.). Always check both EFI and SMC firmware versions and update if necessary before replacing any hardware components in the MacBook Pro.

The following lists describe the type of symptoms that may be resolved by updating the EFI and SMC firmware in the MacBook.

Symptoms that may be resolved by updating EFI firmware:

- L1 Cache reporting as bad
- Boot Camp not booting into Windows
- Built-in FireWire has GUID zero if ExpressCard FireWire is present at boot
- Auto-reboot after wake from sleep
- Stuck in Target Disk Mode upon restart
- Cannot eject media (various conditions)
- Bad media taking too long to eject (including holding mouse button down at startup taking minutes to eject)
- Auto-reboot after wake from sleep

Symptoms that may be resolved by updating SMC firmware:

- Status LEDs on battery do not light until the pack has charged for approximately 10 minutes
- Unusual fan behavior and thermal management issues

Please follow the steps outlined in Knowledge Base article 303364 [About firmware updates for Intel-based Macs](#) to perform an EFI and/or SMC firmware update.

Information about firmware versions for Intel Macs can be found in Knowledge Base article 303880 [Mac OS X: Firmware Updates for Intel-based Macs](#).

---

## Software Troubleshooting Tips and Tools

### Mac OS X 10.5.6 or later only

This computer requires Mac OS X version 10.5.6 or later. Make sure all software updates are applied before starting troubleshooting.

### Safe Mode

Safe Mode is the state Mac OS X is in after a Safe Boot. A Safe Boot is a special way to start Mac OS X when troubleshooting. Starting up into Safe Mode does five things to simplify the startup and operation of your computer:

- It forces a directory check of the startup (boot) volume. It is identical to using Disk Utility's Repair Disk or the `fsck -fy` terminal command.
- It loads only required kernel extensions (some of the items in `/System/Library/Extensions`).
- It disables all fonts other than those in `/System/Library/Fonts`
- It moves to the Trash all font caches normally stored in `/Library/Caches/com.apple.ATS/(uid)/`, where (uid) is a user ID number such as 501.
- It disables all startup items and any Login Items.

To start up into Safe Mode (to Safe Boot), do this:

1. Be sure the computer is shut down.
2. Press the power button.
3. Immediately after you hear the startup tone, press and hold the Shift key.

**Note:** The Shift key should be held as soon as possible after the startup tone but not before.

4. Release the Shift key when you see the screen with the gray Apple and progress indicator (looks like a spinning gear). During the startup, you will see "Safe Boot" on the Mac OS X startup screen. To exit Safe Mode, restart the computer normally, without holding down any keys during startup.

### Knowledge Base Articles

These troubleshooting articles can be searched from <http://www.apple.com/support>.

107392 [What is Safe Boot, Safe Mode?](#)

107394 [Safe Boot Takes Longer Than Normal Startup](#)

106692 [Mac OS X: Troubleshooting Installation and Software Updates](#)

106693 [Mac OS X: Troubleshooting Installation From CD-ROM](#)

106464 [Your Mac won't start up in Mac OS X](#)

25398 [Mac OS X: How to troubleshoot a software issue](#)



# Troubleshooting Steps

Perform the first few steps of troubleshooting whether there is a repairable problem or damage.

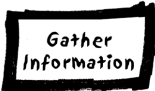

## Gather Information

Gather the normal information about the problem. (If you are not familiar with the normal information to gather, or any of the other steps, see [General Troubleshooting Theory](#).)



## Verify the Problem

Verify that the symptom exists as the customer reports it.



## Try Quick Fixes

Special quick fixes that apply to this computer include:

- Familiarize yourself with normal operating temperature (see Kbase document [30612](#))
- Use firm pressure to seat memory (see Knowledge Base document [303721](#))
- Reset the power manager (See Knowledge Base document [303319](#)).

For more details, see the Symptom Charts section.

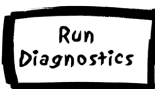

## Run Diagnostics

The following diagnostic tools are available for this product:

- Apple Hardware Test
- Apple Service Diagnostic

See Kbase document [112125](#), “Service Diagnostic Matrix”, to download the appropriate disc image.



## Try Systematic Fault Isolation

There are no special systematic fault isolation techniques for this product.



## Research

If you have not located the issue following the steps so far, try researching the symptoms.

Research resources include:

- Symptom Charts section of this manual
- GSX  
gsx.apple.com  
Enter serial number and click Coverage Check
- Service Source  
service.info.apple.com  
Check Quick Links and/or Technical Resources  
Check options under appropriate Product Service pop-up menu
- Product support page  
service.info.apple.com  
Choose MacBook Support Page from the appropriate Product Service pop-up menu
- Knowledge Base  
search.info.apple.com
- Self-paced service training  
service.info.apple.com  
Choose Service Training from the Product Service pop-up menu

## Escalate

Follow the practices and policies of your business or agency.



## Repair or Replace

Once you locate the trouble you will most likely need to repair the unit, or mail it in to an AppleCare Repair Center, depending on the service strategy in your region. Be sure to include the CompTIA code, the troubleshooting steps you performed, and the results in the Service Instructions section of GCRM and/or GSX.

If the symptoms point to a component on the logic board, use the [block diagram](#) at the end of this chapter to help determine whether you need to replace the entire logic board.

Also be aware of the following parts that customers may replace themselves (known as Do-It-Yourself parts):

- Hard drive
- AC adapter
- RAM
- Battery

**Note:** For the current list of Do-It-Yourself parts, see the product support website.



## Verify the Repair

To verify the repair:

1. Try to recreate the original symptoms. You should not be able to. (If you can, return to the beginning of the troubleshooting flowchart.)
2. Perform the preventive maintenance tasks for this product.  
For this computer this includes only cleaning the display and case.



## Inform the User

Include in the case notes all that you have done. The customer may like a copy of any diagnostic reports.

**Important:** For any unit you send on to a repair center, include the CompTIA code, symptoms, steps to reproduce, and troubleshooting steps you have completed thus far in the Service Instructions section of GCRM and/or GSX. (Service Instructions are also known as FAI notes.)

## Complete Administrative Tasks

There are no particular administrative tasks for this product, other than those required by the internal policies of your business or agency.



# Symptom Charts

## When to Use the Symptom Charts

Before turning to the symptom charts, you should have completed the following steps on the Apple General Troubleshooting Flowchart:

1. Gather information
2. Verify the problem
3. Try quick fixes

You consult the symptom charts as part of the Research troubleshooting step (and sometimes as part of the Try Quick Fixes step).

## How to Use the Symptom Charts

The Symptom Charts included in this chapter will help you diagnose specific symptoms related to the product. Cures are listed on the charts in the order of most likely solution: try the cures in the order presented. Verify whether or not the product continues to exhibit the symptom. If the symptom persists, try the next cure.

**Important Note:** If a step instructs you to replace a module, and replacing that module does not resolve the symptom, reinstall the original module before you proceed to the next step.

## AirPort

### AirPort Extreme Card not recognized

1. Use Software Update in Mac OS X system preferences or see the Apple Software Updates web page to make sure the latest version of AirPort software is installed.
2. Reset PRAM. Restart the computer, then hold down the Option-Command-P-R keys until you hear the startup sound at least one additional time after the initial startup sound.
3. Reset the SMC. See Knowledge Base article [HT1411](#), "Resetting MacBook and MacBook Pro System Management Controller (SMC)". Resetting the SMC means you will also need to reset the date and time (using the Date & Time pane of System Preferences).

**Warning:** Make sure you do not hold down the "fn" key when resetting the SMC.

4. Check Network pane in System Preferences to verify AirPort port is selected.
5. Use Apple System Profiler to verify that the computer is recognizing AirPort.

- 
6. Reseat AirPort Extreme Card and make sure AirPort antenna cables are fully connected.
  7. Start up from the Mac OS X Leopard disc.
  8. Remove and reinstall the AirPort software.
  9. Replace with known-good AirPort Extreme Card.
  10. Replace logic board.

### Poor AirPort reception

Refer to Knowledge Base article [88258](#) "Optimizing AirPort reception in portable computers."

1. Use Software Update in System Preferences or see the Apple Software Updates web page to make sure the latest version of AirPort Extreme software is installed.
2. Check for other changes in the environment that may cause interference with the AirPort signal. For more information, consult Knowledge Base article [58543](#): "AirPort: Potential sources of interference."
3. Reseat the AirPort Extreme card in its slot.
4. Reseat AirPort Extreme and Bluetooth antenna cables on cards.
5. Check AirPort Extreme and Bluetooth antenna cables for damage.
6. Replace with known-good AirPort Extreme Card or Bluetooth card.
7. Replace AirPort Extreme or Bluetooth antenna cables.

## Temperature Issue

### Unit unusually hot

This computer runs hotter than previous models. However, the normal operating temperature is well within national and international safety standards. Nevertheless, customers may be concerned about the generated heat. To prevent an unneeded repair, you can compare a customer's computer to a running model, if available, at your repair site.

1. Verify that the customer uses the computer while it is placed on a flat, hard surface.
2. Verify that the computer is hotter than expected for normal operation. If possible, compare how hot the computer case feels with how hot the case of a running display model feels.
3. Is the computer running hotter than normal?  
**Yes:** Proceed to the next step.  
**No:** The unit is operating normally. Proceed to the Inform Customer step on the flowchart. When speaking with the customer, direct him or her to Knowledge Base article [30612](#): "Apple Portables: Operating temperature."
4. Use Activity Monitor to check for runaway applications. Refer to Knowledge Base article [304882](#): "Runaway applications can shorten battery run time."

- 
5. Check the processor speed.
  6. Is the processor speed running at the setting the customer set?  
**Yes:** Continue with the next step.  
**No:** The computer could be overheating. The operating system will automatically reduce the processor speed if the computer starts to get too hot. Continue with the next step.
  7. Check for a failed fan.
  8. Can you hear the fan running?  
**Yes:** Continue with the next step.  
**No:** This computer has only one fan. If the unit feels too hot and you do not hear a fan running or cannot feel the air venting over the top of the keyboard, the fan may have failed. Follow the troubleshooting steps in the next section under "Fan fails," and then if need be, proceed to the Take Apart procedure for replacing the fan.
  9. Check for misplaced thermal grease.  
Each processor chip should have .01 to .12 cc (one-third of a single syringe) of grease on it. It should look completely covered. See the Heatsink section of the Take Apart chapter for complete details.
  10. Is the thermal grease applied in the right places and in the right amount, according to the service manual?  
**Yes:** You have eliminated all the immediately known potential causes of an unusually hot unit. Proceed to the Systematic Fault Isolation step of the troubleshooting flowchart.  
**No:** Apply the thermal grease correctly, according to the instructions in the service manual then proceed to the Verify Repair step of the troubleshooting flowchart.

For more information on the operating temperature of Apple portable computers, see Knowledge Base article [30612](#): "Apple Portables: Operating temperature." You may also want to point out this article to the customer.

## Fan fails

1. Check fan cable connection, and check cable for damage. Reseat if necessary.
2. Check fan for loose parts stuck in fan blades.
3. Replace fan.
4. Replace logic board.

## Memory

### Memory not recognized; beeping tones

You may need to use increased firm pressure when installing memory. If you or the customer do not fully seat the memory the computer will not start up, or System Profiler may not recognize the memory. See Knowledge Base article [303721](#): "MacBook: How to install memory."

1. Try ejecting the memory and reseating it.

- 
2. Try known-good memory.
  3. Replace the logic board.

## Power, Battery, or Startup Issue

**Note:** If power is available to the system from the battery and/or AC power adapter, pushing the power button will start up the system and begin the startup process.

- The screen will stay dark. The sleep LED will glow solid. This will last a few seconds.
- As the system starts up, a power-on self test (POST) will be performed. See “POST Error Codes” listed later for failure results.
- If the system is not muted, you will hear a startup chime. The backlight will turn on and the sleep LED will turn off.
- The screen will turn gray. The Apple logo will appear and then the turning gear will appear.
- The desktop pattern will show up, as well as the menu bar start populating.

Power, but no video (computer begins to start up, fan and hard drive spins, Caps Lock key lights up when pressed, but there is no startup sound or video)

**Note:** Examine the display carefully. An image may be barely present on the screen, but with no backlight clearly illuminating the image. In this case, the system is working properly except for the backlight. Refer to “No display or dim display” troubleshooting symptom to resolve this issue.

1. Reseat memory cards. Try known-good memory.

If you or the customer do not fully seat the memory, the computer will not start up. See Knowledge Base articles [303083](#), “Intel-based Mac Power On Self Test RAM error codes,” and [303721](#): “MacBook: How to install memory.”

2. Reset the SMC. See Knowledge Base article [303319](#), “Resetting MacBook and MacBook Pro System Management Controller (SMC).” Resetting the SMC means you will also need to reset the date and time (using the Date & Time pane of System Preferences).

**Warning:** Make sure you do not hold down the “fn” key when resetting the SMC.

3. Press F2 (with the fn key pressed and not pressed) to increase the screen brightness setting.
4. Try connecting an external display to check for intact video signal. If external video appears, check the system for any pending software or firmware updates and update accordingly.
5. Verify that the LVDS cable connection is properly seated to its connector on the logic board and that the cables are not damaged.
6. Reseat inverter cable.
7. Replace the display assembly.
8. Check all cable and flex connections to the logic board. Try restarting.
9. Replace the logic board.

---

No power, no video (no sleep light, no fan movement, no hard drive spin, no Caps Lock LED when pressed, and no display illumination)

**Note:** After each step, check that the system is not supplying power to the logic board. If you see the sleep LED come on or the Caps Lock LED illuminate when the key is pressed, then the system is indeed drawing power. In this case, hold down the power button for six seconds to ensure the system is shut down before working on the computer. At this point, the issue is no longer a 'No Power, No Video' problem. Move on to the "Power, but No Video" troubleshooting section.

**Note:** Examine the display carefully. An image may be barely present on the screen, but with no backlight clearly illuminating the image. In this case, the system is working properly except for the backlight. Use the "No display or dim display" symptom to resolve this issue.

1. Remove any connected peripherals.
2. Check that the battery has enough charge to start the computer by pressing the button next to the LEDs on the battery (on the bottom of the machine). At least one LED must light continuously (not flashing). Make sure the battery is fully seated.
3. Connect a known-good Apple 60W MagSafe Power Adapter and power cord to a known-good power outlet. If the cord is properly inserted, the LED should light up; if not, go to the "MagSafe power adapter" symptom.
4. Check for damaged pins or magnetic debris on MagSafe power adapter. If pins are okay, reseal power adapter connector and make sure it is fully inserted. Refer to Knowledge Base articles [303566](#) "MacBook Pro: Troubleshooting MagSafe power adapters with stuck pins" and [302461](#) "Portable Computers: Troubleshooting power adapters."
5. Try powering up without the battery installed. If it starts up, try a known-good battery. If it does not boot, replace the battery connector cable.
6. Press Caps Lock key to see if light on key comes on. If it does, hold power button down for six seconds to shut down the computer and restart.
7. Reset PRAM. Restart the computer, then hold down the Option-Command-P-R keys until you hear the startup sound at least one additional time after the initial startup sound.
8. Reset the SMC. See Knowledge Base article [303319](#), "Resetting MacBook and MacBook Pro System Management Controller (SMC)". Resetting the SMC means you will also need to reset the date and time (using the Date & Time pane of System Preferences).

**Warning:** Make sure you do not hold down the "fn" key when resetting the SMC.

9. Try to power up the system and check the sleep indicator. If the LED lights up solidly and turns off, the logic board is getting power and completing the boot cycle. Go to the "Power, but No Video" troubleshooting section.
10. Verify that the power button cable is connected properly to the top case flex cable assembly and that the flex cable is connected correctly to the logic board. Try turning on the system.
11. Disconnect the top case. Inspect the connectors. With the top case removed, restart the system using the on-board startup jumper pads, as shown below. If it starts up, replace the top case.

**Caution:** Use a jeweler's flat-blade screwdriver that is just wide enough to short the two small solder pins (jumper pads) located directly below the power symbol.

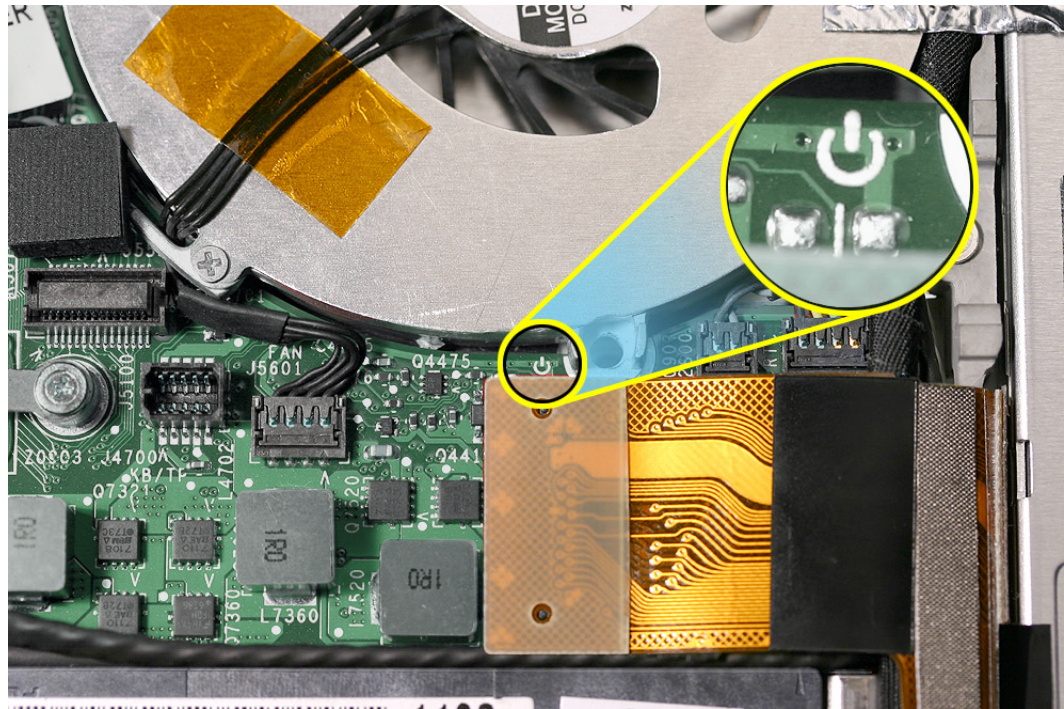

12. Test each RAM slot individually with known-good RAM. (The computer should still start with only one known-good DIMM.)
13. Try removing the AirPort Extreme card from its socket and start the computer. If it starts, shut it down and check the flex cable connector and the connector on the logic board and replace the damaged parts.
14. Reseat these cables:
  - Hard drive flex cable (will start up to flashing folder if not connected or corrupt)
  - Optical drive flex cable
  - Trackpad flex cable
  - LVDS cable
  - Battery connector with sleep switch cable
15. If computer starts on battery power only, replace MagSafe board with a known-good MagSafe DC-in board.
16. If computer starts up, inspect any suspect flex cable connectors and their terminals on the logic board for damage and replace any damaged parts.
17. Replace logic board.

### MagSafe power adapter LED does not turn on

1. Confirm the power adapter is connected to a known-good outlet.
2. Try replacing the AC plug or AC power cord. If the adapter works, replace the plug or cord.

3. Check the pins in the power adapter's DC plug for pins that are stuck down.



4. If pins are stuck down, try cleaning the contacts.

**Note:** Debris removal should be done with a soft, non-electrostatic generating (non-plastic bristle) brush. A tool such as a cotton swab may introduce foreign material that will cause the pins to seize up. If the pin has become stuck, try working the pin to release it.

5. If the LED on the connector does not light up, there may be contamination in the MagSafe port. The contact pins can be dirty. It can be cleaned with a soft brush. Do not use liquid.

In addition, foreign material may cover the contacts or prevent the MagSafe connector plug from seating enough to allow the sense pin to connect to the system.

6. Check if pins are missing or bent. If so, replace the power adapter.

For further information on MagSafe power adapters, consult these Knowledge Base articles:

[302461](#): Portable Computers: Troubleshooting power adapters

[303240](#): Use and cleaning of power adapter with MagSafe connector

[303566](#): Troubleshooting Magsafe power adapters with stuck pins

[306446](#): Apple Portables: Reducing cable strain on your MagSafe power adapter

Blue screen appears (a spinning disc cursor may also be visible), Prohibitory Sign appears (a), Kernel Panic dialog box appears (b), or Gray screen during startup



a) Prohibitory sign

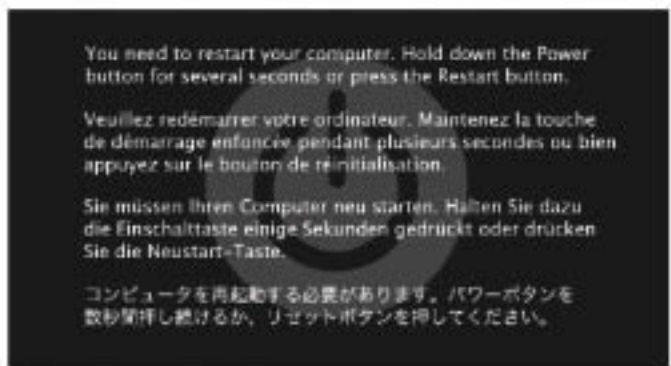

b) Kernel panic dialog box

1. Make sure all external devices are disconnected. If the kernel panic goes away, troubleshoot the external device by reconnecting each device until the panic occurs.

2. If there are two RAM cards installed in the expansion slots, remove left RAM card and restart.
  - If symptom repeats, replace left card with known-good RAM card.
  - If symptom does not repeat, replace right card with known-good RAM card and restart.

For assistance in software troubleshooting, go to Knowledge Base article: [106805](#): Mac OS X: “Broken folder” icon, prohibitory sign, or kernel panic when computer starts

### System shuts down intermittently

1. Check for any firmware updates and make sure Mac OS X is up to date.
2. Disconnect all external peripherals.
3. Consult system.log for possible shutdown error codes using Console (in Utilities folder).

Shutdown Code	Potential Indication, Issue and/or Fix
3	Normal behavior... power button was pressed for more than four seconds to force shutdown.
0, -5	Normal behavior... regular shutdown
-60	Low battery; try charging battery.
-70	Replace top case.
-72	1) reseal thermal sensor cable at heatsink (if present) 2) reapply thermal paste 3) replace heatsink
-74	1) battery temperature exceeded; swap battery for known-good battery 2) replace battery
-78	Replace logic board
-82	Test thermal sensor cable at heatsink (if present) for improper seating or damage. Replace heatsink.

4. Reseat RAM and test again.
5. Make sure a known-good fully charged battery is fully inserted. Check that the battery connector and sleep switch is fully engaged and is not broken or getting caught before fully catching. Check battery connection to logic board.
6. Make a visual inspection of the battery connector in the battery bay. The battery connector should allow for some play to align to the battery terminals. Make sure all blades are visible and not bent. If damaged, replace the battery connector.
7. Make sure the system is not overheating, the air vents are clear and the unit was not used on a soft surface.
8. Check that the fan cable is securely connected and the fan is operational.
9. Remove the battery and connect a known-good 60W power adapter and power cord or plug to a known-good power source. If the DC plug is properly seated, the LED should light up. If not, consult the “MagSafe power adapter” symptom.
10. Verify that the thermal sensor connector at the heatsink (if present) is well seated to the logic board and that there is no damage to the cable.

11. Run ASD diagnostics to determine if any of the thermal sensors are not functioning correctly. Replace any failing sensors. See chart below for correlation between error code and part.

Name	Location
TCOD, TCOP, TGOP, TGOT, TGOD, Th0H	Logic board
TBOT	Main battery
TWOP	AirPort Extreme Card
TsOP	Top case
Th1H	Thermal sensor on heatsink

12. Check that the thermal grease between the heatsink and logic board is in contact by unscrewing the logic board screws and gently pulling up on the left side of the board to verify resistance caused by adhesion of the thermal material. If not, reinstall new thermal grease for the logic board and heatsink.
13. Replace the heatsink.
14. Replace the logic board.

More details about the MacBook intermittent shutdown issue is available in Knowledge Base article [304308](#) "MacBook: Shuts down intermittently".

### System shuts down almost immediately after startup

1. Disconnect all external peripherals.
2. Make sure a known-good battery is fully inserted. Check battery charge and make sure that at least two LED charge indicators light up; otherwise connect the adapter. The adapter LED should light when plugged in. If not, consult the "MagSafe power adapter" symptom for further troubleshooting.
3. After charging for a while, if the battery does not seem to charge, or if it is charged up but quickly discharges, replace the battery. Verify with a known-good battery.
4. Check battery connection to logic board, and check cable attachment to connector.
5. If just before the system shuts down, the sleep LED briefly comes on, check the thermal sensor cable (if present) connection between the heatsink and the logic board. It should be fully seated with no damage to the wiring. If damaged, replace the heatsink.
6. Replace the logic board.

### Battery won't charge

1. Plug in the power cord for five minutes to revive a drained battery. Refer to Knowledge Base article [304301](#): "MacBook and MacBook Pro: Battery not recognized after being fully drained."
2. Check for correct battery insertion and reseat.
3. Remove any connected peripherals.
4. Try known-good power outlet.
5. Try known-good power adapter and power cord.

---

**Note:** Verify that power adapter connector LED glows amber or green. If the LED is green, turn the computer over and press the battery button. The battery lights should glow green and stay on if the power adapter is operating correctly.

6. If the computer is on Mac OS X 10.4.8 or later, check to see if the latest Battery Update has been installed. Do not replace a battery unless Battery Update 1.2 (or later) has been installed. For complete instructions, refer to Knowledge Base article 305256: "About Battery Update 1.2."
7. For retail or dispatch service providers only: Be sure to record the Full Charge Capacity (FCC) and Cycle Count values in your case notes. If the computer is on Mac OS X 10.4 or later, these values can be found in Apple System Profiler: Hardware: Power: Battery Information.
8. Try known-good battery.
9. Reset the SMC. See Knowledge Base article [303319](#), "Resetting MacBook and MacBook Pro System Management Controller (SMC)": Resetting the SMC means you will also need to reset the date and time (using the Date & Time pane of System Preferences).

**Warning:** Make sure you do not hold down the "fn" key when resetting the SMC.

10. Try known-good MagSafe DC-in board and cable assembly.
11. Replace battery connector with sleep switch.
12. Replace logic board.

#### Battery not recognized, does not charge, or does not reach 80% capacity

1. Plug in the power cord for five minutes to revive a drained battery. Refer to Knowledge Base article [304301](#): "MacBook and MacBook Pro: Battery not recognized after being fully drained."
2. To properly evaluate the battery, follow the steps in Knowledge Base article [500644](#): "Portable Computer Battery Screening Process."
3. If the computer is on Mac OS X 10.4.8 or later, check to see if the latest Battery Update has been installed. Do not replace a battery unless Battery Update 1.2 (or later) has been installed. For complete instructions, refer to Knowledge Base article 305256 About Battery Update 1.2.
4. For retail or dispatch service providers only: Be sure to record the Full Charge Capacity (FCC) and Cycle Count values in your case notes. If the computer is on Mac OS X 10.4 or later, these values can be found in Apple System Profiler: Hardware: Power: Battery Information.

Also see [305364](#): MacBook, MacBook Pro: Battery not recognized or "X" icon appears on menu bar. (The "X" icon appears on computers running operating systems prior to Mac OS X 10.5.)

---

## Power-On Self Test (POST) Error Codes

The computer automatically performs a power-on self test when it is turned on after being fully shut down (not a restart). This section describes what to do if you hear beeps during startup. When this occurs, the sleep LED will stay on, occasionally flashing.

This computer relies on a combination of tones and blinking sleep LEDs to display power-on self test (POST) error codes.

If the computer detects no SDRAM (Synchronous Dynamic Random Access Memory—also referred to as RAM), or the RAM installed does not meet the appropriate specifications, the screen will remain black but the power LED on the front of the computer will blink once per second to signal the error. This error condition may be due to physically damaged RAM, the incorrect type of RAM, or not having any RAM installed.

Some RAM may appear to pass the power-on self test (POST) but still cannot be addressed by the operating system. In this case, the computer will display a gray screen, sound three tones and blink the power LED on the front of the computer three times, pause, and repeat the blinking until the computer is turned off.

See Knowledge Base articles [303083](#): Intel-based Mac Power On Self Test RAM error codes, [303363](#): Intel-based Mac: Startup sequence and error codes, symbols.

## Optical Drive

### Optical drive does not accept CD / DVD disc (mechanical failure)

The optical drive on this computer has narrow tolerances for the recommended optical media. If the drive does not accept discs, the wrong kind of disc could be inserted. Advise customer to use discs no thicker than 1.5 mm. See Knowledge Base article [88275](#), “MacBook Pro, MacBook, PowerBook G4, iBook G4: Troubleshooting the slot load disc drive”.

1. Verify disc is a standard 12-cm circular disc, is not warped, and is facing right side down.
2. Verify drive slot has no foreign object in channel and is not compressed or damaged.
3. Check for a small (non-standard) disc or other foreign object stuck inside. Remove the optical drive from the system to extract a stuck disc. See “Removing a stuck disk” in the optical drive chapter of the take apart section.
4. Verify disc is properly seated in the carrier.
5. Check that the optical drive flex cable is undamaged and properly installed.
6. Replace optical drive.

See Knowledge Base article [88288](#) “Apple Portables: Tips for inserting discs into disc drive.”

---

### Disc will not eject

1. Verify disc is not in use by quitting any applications that may be using the disc.
2. Verify drive slot is not blocked, bent, compressed or damaged.
3. Press and hold Media Eject key at top right corner of keyboard. If that does not work, hold down Function (fn) key then Media Eject key in sequence, then together simultaneously.
4. Drag disc icon to trash, or select it and press Command-E.
5. Choose Restart from Apple menu, then hold down trackpad button during startup.
6. Check the optical drive flex cable for proper connection to the logic board.
7. Reseat the optical drive mechanism. Make sure the drive is oriented toward the back of the computer, and that all four corners are seated, so that the drive sits flat in its bay.
8. Replace the optical drive.

### Disc icon does not show up on desktop, does not mount, or a dialog box appears to initialize disc when inserting a read-only disc

1. Verify disc is a standard 12-cm circular disc, is not warped, and is facing right side down.
2. Use the Software Update system preference pane to check for updated firmware.
3. Try cleaning the disc. It may not mount if dirty or scratched.
4. Verify media is positioned correctly: data side down.
5. Try a different, known-good disc.
6. Listen to verify that the disc spins.
7. Reseat optical drive cable.
8. Verify the logic board connection by trying a known-good optical drive and disc.
9. Replace optical drive cable.
10. Replace optical drive.

### Difficulty writing to optical media

1. Verify disc is a standard 12-cm circular disc, is not warped, and is facing right side down.
2. Try a different brand or speed of CD-R disc.

**Note:** Some brands of CD-R media may not work with the optical drive.

**Note:** There are two factors in the ability for the optical drive to write to media.

- First, there are varying qualities of blank optical media. Some media are made to such low specifications that the ability for the drive to write to it is marginal. There are variations in optical media even under the same brand. Some brands source their optical media from a variety of manufacturers, so there may be variations in the quality.
- Second, an optical drive that supports writing to a CD-R/RW or DVD-R/RW disc requires a special writing algorithm for discs from different disc manufacturers. There

---

are hundreds of disc manufacturers, it is impossible to implement writing algorithms for each disc manufacturer. Usually, drive manufacturers implement special writing algorithms for discs from major disc manufacturers. For discs that are not supported by the drive with special writing algorithms, the drive will use a generic writing algorithm to write the disc. In this case, the ability to write and read may not be optimal.

3. Use the Software Update system preference pane to check for updated drivers or firmware.
4. Replace the optical drive flex cable.
5. Replace the optical drive.

## Keyboard and Trackpad

### Keycap damaged or sticking

If a keycap is damaged, you may be able to replace just a keycap rather than the entire top case. Refer to "[Keycap Replacement](#)."

### Trackpad works intermittently

Note: When running Apple Hardware Test or Apple Service Diagnostic, the trackpad will respond with very small movements of the cursor. This behavior is normal.

The trackpad operation can be affected by hand lotion, humidity, dangling jewelry, magnets, and the use of more than one finger on the trackpad.

1. Check for environmental factors such as humidity, hand lotion, or jewelry.
2. Clean the trackpad surface (with the computer off) using a clean, dry, lint-free cloth.

For more information, see Knowledge Base articles: [17228](#): "Portables: Jumpy or Erratic Trackpad Operation"; [58389](#): "Your PowerBook and iBook's trackpad doesn't respond"

## USB / FireWire Ports

### USB port is not recognizing known devices

1. Shut down the computer; then start it up by pressing the power button.
2. Use Software Update in Mac OS X system preferences to verify the latest software is installed.
3. Use Apple System Profiler to verify that the computer is recognizing the bus.
4. Test USB port with a known-good Apple keyboard or mouse.
5. Verify that the USB port provides power to the device by checking the device's LED indicator.
6. Verify that drivers are installed properly for third party devices, if needed.
7. Reset the SMC. See Knowledge Base article [303319](#), "Resetting MacBook and MacBook Pro System Management Controller (SMC)". Resetting the SMC means you will also need to reset

---

the date and time (using the Date & Time pane of System Preferences).

**Warning:** Make sure you do not hold down the “fn” key when resetting the SMC.

8. Try another port if available.
9. Try a different cable.
10. Replace logic board.

## Video

No display, or dim display, but computer appears to operate correctly (if dim, display shows startup icon and/or desktop)

1. Remove any connected peripherals.
2. Try known-good power outlet, power adapter and power cord.
3. Make sure the F1 key is not stuck down.
4. Press F2 (with the fn key pressed and not pressed) to increase the screen brightness setting.
5. Open Display system preference panel and check brightness. If works, replace keyboard.
6. Reset PRAM. Restart the computer, then hold down the Option-Command-P-R keys until you hear the startup sound at least one additional time after the initial startup sound.
7. Reset the SMC. See Knowledge Base article [303319](#), “Resetting MacBook and MacBook Pro System Management Controller (SMC)”. Resetting the SMC means you will also need to reset the date and time (using the Date & Time pane of System Preferences).

**Warning:** Make sure you do not hold down the “fn” key when resetting the SMC.

8. Connect an external display, and check for video on external display.
9. If video is fine on external display, troubleshoot LCD panel and verify cable connections to inverter and LCD.
10. If video symptom is same on external display, replace logic board.
11. Verify LCD panel cable and LVDS cable connections are seated properly and that the cables are not damaged.
12. Replace LCD panel.
13. Replace logic board.

No display or dim display, but computer appears to operate correctly and has video operating on external display (display is fine after startup, but after a few seconds no display or dim display)

1. Remove any connected peripherals.
2. Try known-good power outlet, power adapter, and power cord.

3. Press F2 (with the fn key pressed and not pressed) to increase the screen brightness setting.
4. Reboot the computer—hold down the Control and Command keys and press the Power button, or press and hold the Power button for 5 to 10 seconds to shut down the computer, then press the Power button to restart.
5. Reset the SMC. See Knowledge Base article [303319](#), “Resetting MacBook and MacBook Pro System Management Controller (SMC)”. Resetting the SMC means you will also need to reset the date and time (using the Date & Time pane of System Preferences).

**Warning:** Make sure you do not hold down the “fn” key when resetting the SMC.

6. Reset PRAM. Restart the computer, then hold down the Option-Command-P-R keys until you hear the startup sound at least one additional time after the initial startup sound.
7. Connect an external display, and check for video on external display.
  - If video is fine on external display, troubleshoot LCD panel and verify cable connections to inverter and LCD. Verify battery connector with sleep switch connection.
  - If video symptom is same on external display, replace logic board.
8. Verify that LCD panel cable and LVDS cable connections are seated properly and that the cables are not damaged. Check cables around the hinges for damage.
9. Replace Inverter board.
10. Replace battery connector with sleep switch.
11. Replace LCD panel.
12. Replace logic board.

**Display Issue:** When displaying a single color over the screen area, the LCD panel shows one or more pixels that are not properly lit

To determine if the display has an acceptable number of pixel anomalies, follow the steps below:

1. Set the display image to one of the following colors: all-white display, all-red display, all-green display, all-blue or all-black display. Knowledge Base article [112125](#): “Service Diagnostics Matrix”, has the LCD Tester Diagnostic Utility that will generate these patterns on the screen.
2. Using a jeweler’s loupe, pocket microscope, or other magnifying device, identify and count each pixel anomaly:
  - Bright subpixel anomaly = subpixel that is always on
  - Dark subpixel anomaly = subpixel that is always off
3. The number of acceptable pixel anomalies for this computer is:

Bright	Up to 3
Dark	Up to 5
Combination	Up to 7

- 
- If the number of subpixel anomalies exceeds the acceptable number listed in the above chart, replace the LCD panel.

Bright	4 or more
Dark	6 or more
Combination	8 or more

- If the number of subpixel anomalies is acceptable, explain to the customer that the pixel anomalies are within specifications, and no repair is necessary.

**Important:** Do not release the specifications to customers. Instead, inform them that a certain number of subpixel anomalies are considered acceptable, and these factors apply to all manufacturers using LCD technology—not just Apple products.

When speaking with customers, please use the following explanation:

Active-matrix LCD technology uses rows and columns of addressable locations (pixels) that render text and images on screen. Each pixel location has three separate subpixels (red, green, and blue) that allow the image to be rendered in full color. Each subpixel has a corresponding transistor responsible for turning the subpixel on or off.

There are typically millions of these subpixels on an LCD display. For example, the LCD panel used in the Apple Cinema HD display is made up of 2.3 million pixels and 6.9 million red, green, and blue subpixels. Occasionally, a transistor does not work perfectly, which may result in the affected subpixel being turned on (bright) or turned off (dark). With the millions of subpixels on a display, it is quite possible to have a low number of faulty transistors on an LCD. Therefore, a certain number of subpixel anomalies are considered acceptable. Rejecting all but perfect LCD panels would significantly increase the retail price for products using LCD displays. These factors apply to all manufacturers using LCD technology—not just Apple products.

## Sound Output

### Distorted sound from speaker(s)

- Verify sound is correct with known-good external speakers/headphones. If sound is correct, replace top case.
- Verify speaker cables are inserted correctly, and check cables for damage.
- Check balance in System Preferences: Sound: Output.
- Compare the same sound and same settings with two different units to make sure that sound is actually distorted.
- In System Preferences, open Sound, select Output, and set the slider bar to either the left or right speaker. Play a sound to tell which speaker is not responding and may need replacement. Based on results, replace either the left or right speaker.
- Replace logic board.

---

## No sound from speaker(s)

1. Use Software Update to verify that the latest audio update has been installed.
2. Press the F3 key (with 'fn' key pressed and not pressed) to verify mute mode is not enabled.
3. Press the F4 or F5 key (with 'fn' key pressed and not pressed) to check the volume setting.
4. Check the speakers tab on the Sound control panel to confirm that the software is correctly detecting that there are no external speakers or headphones connected. If so, use the previous troubleshooting procedure that addresses distorted sound from speakers.
5. In System Preferences, open Sound, select Output, and set the slider bar to either the left or right speaker. Play a sound to tell which speaker is not responding and may need replacement. Based on results, replace either the left or right speaker.
6. Verify sound output with known-good headphones or external speakers.
7. Shut down computer and restart.
8. Reset PRAM. Restart the computer, then hold down the Option-Command-P-R keys until you hear the startup sound at least one additional time after the initial startup sound.
9. Verify that the speaker cables are connected properly to the logic board, and check cables for damage.
10. Replace logic board.

Related Knowledge Base articles: [58463](#): iBook: Sound Capabilities, [303719](#): About the MacBook Sound Output port

## Applications

### Windows XP will not install correctly

Using Boot Camp, Windows XP may not install correctly on this computer when an Apple Mighty Mouse is plugged in. Use the computer's built in trackpad until after Windows XP is installed and Windows recognizes the trackpad.

For more support about Boot Camp, see: <http://www.apple.com/support/bootcamp/>

### Application quits, Kernel Panic, or other startup problems

1. If a specific application quits, reinstall the application. Verify that the application is compatible with Mac OS X 10.5 or later.
2. Use Disk Utility to repair permissions on the boot volume.  
**Note:** For instructions, see Knowledge base article [Testing and repairing disk permissions](#)
3. Reset PRAM. Restart the computer, then hold down the Option-Command-P-R keys until you hear the startup sound at least one additional time after the initial startup sound.
4. Try to log in as a new user.

- 
5. Run Disk Utility from the Software Install and Restore DVD.
  6. Perform a clean install of system software with the software install and restore disc that came with the computer.
  7. Restart the system.
  8. Run Apple Service Diagnostic (ASD) in loop mode (Control-L) for an extended time to test the memory. If the test finds bad memory, replace the DIMMs one at a time and test until all bad DIMMs are replaced with known-good modules.
  9. Replace the logic board.



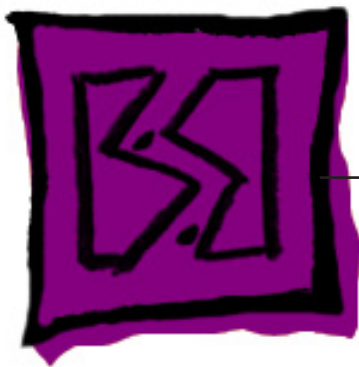

## Views

---

MacBook (13-inch, Early 2009)

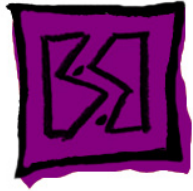

## External and Internal Views

### Front: Keyboard and IR Window



---

**Back: Air Vents and Display Clutch**



**Left Side: Ports**



**Right Side: Slot Drive**



---

## Battery Bay: Memory Card Levers and Hard Drive Pull Tab

**Important:** The following image shows the memory cards and hard drive installed in the battery bay with the L-shaped RAM door removed. Note the correct position of the memory card levers. Some images pictured in this manual used a pre-production model, so the direction and appearance of the levers differs from the accurate depiction shown.

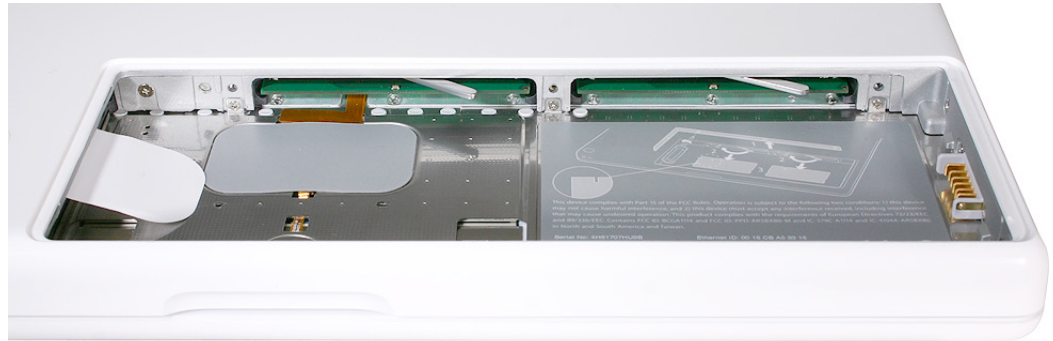

## Top Case Removed: Main Modules and Cable Routing

Refer to the following images in this section for an accurate depiction of the main modules and cable routing with the top case off.

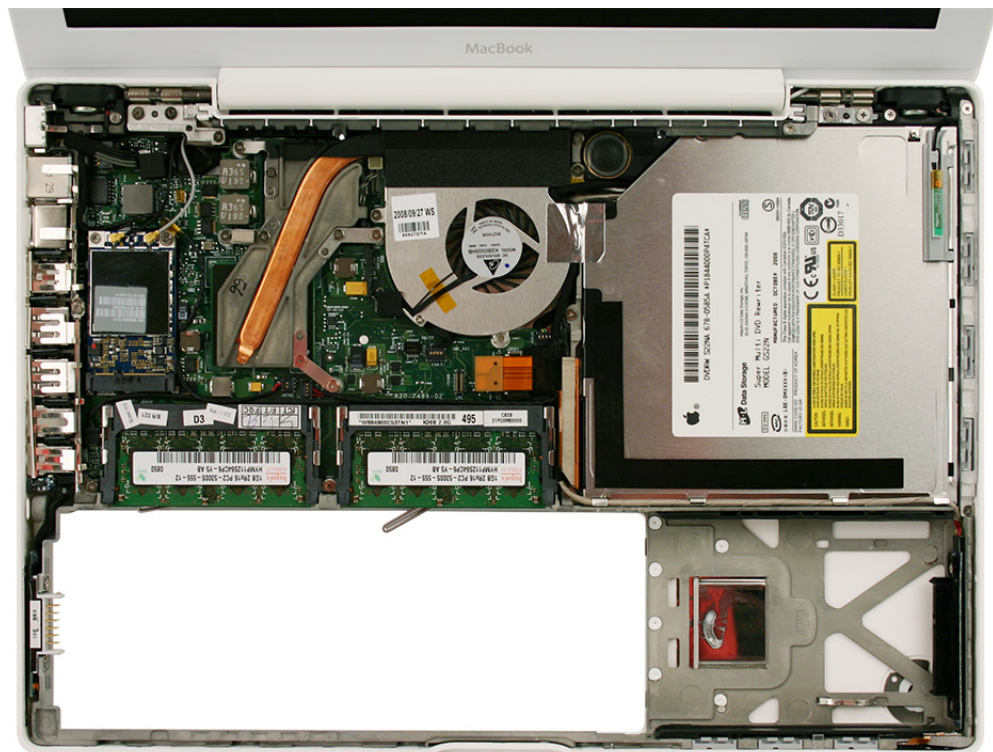

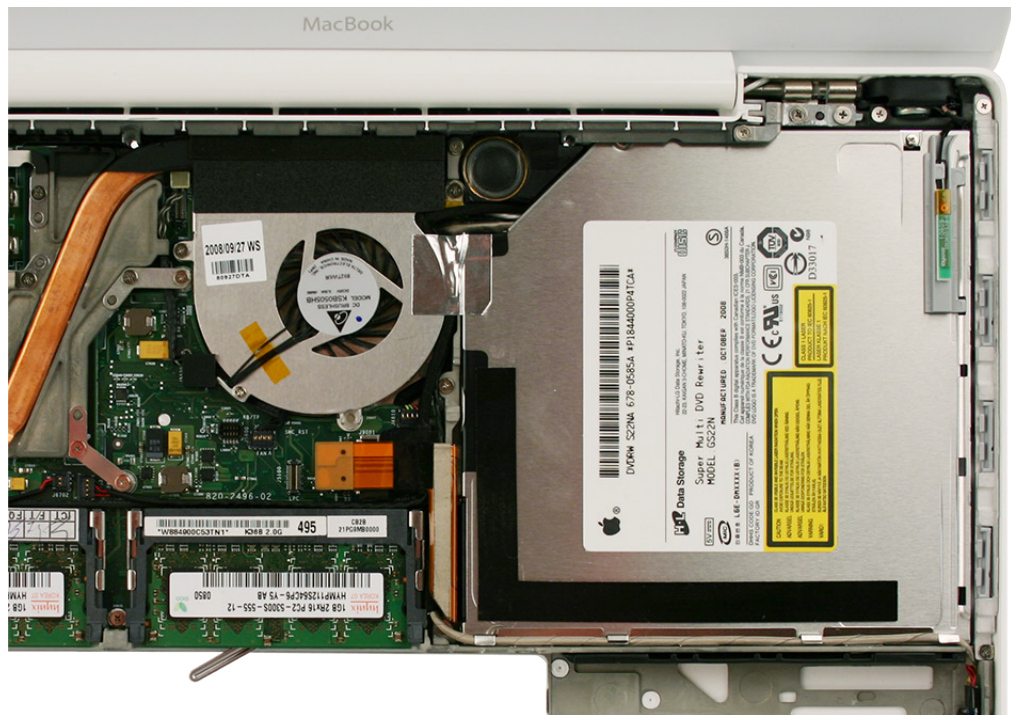
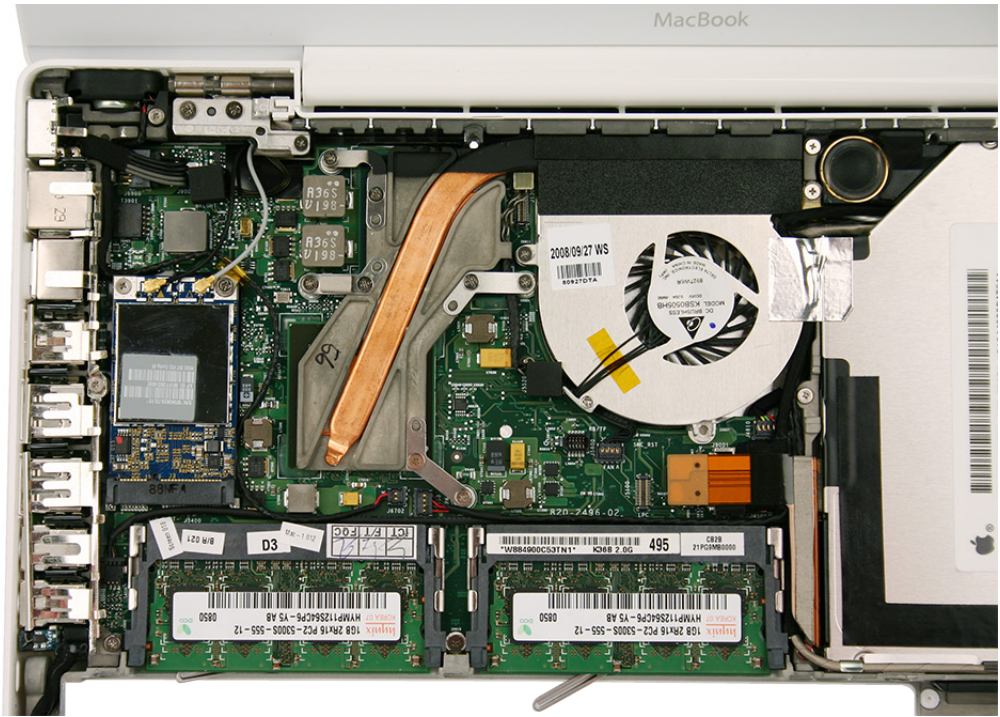

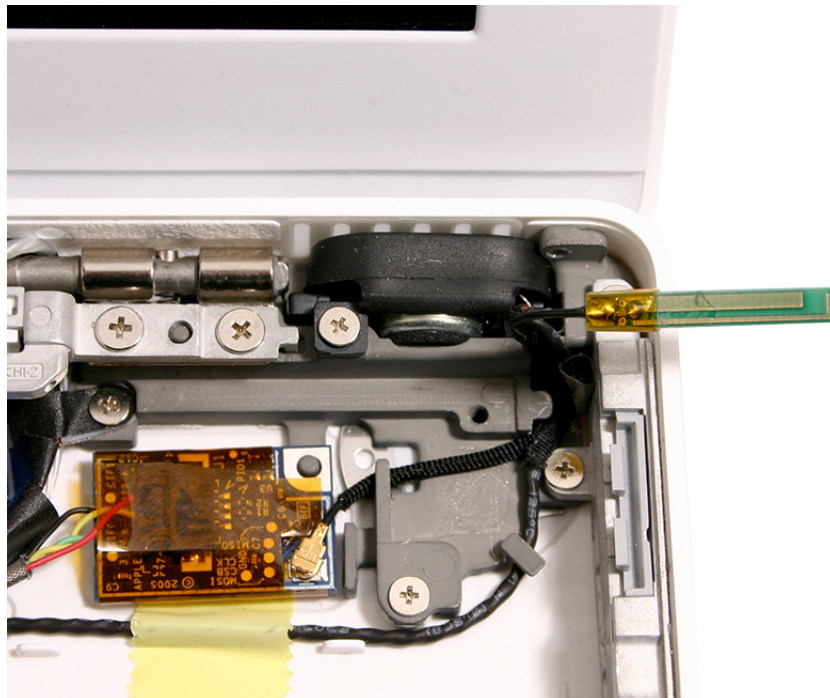
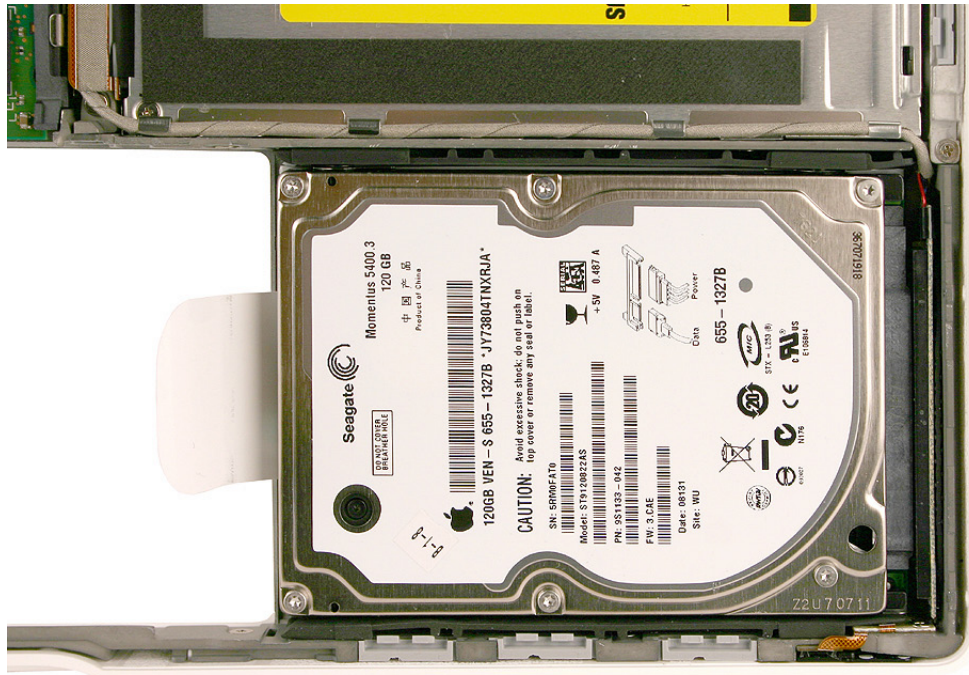



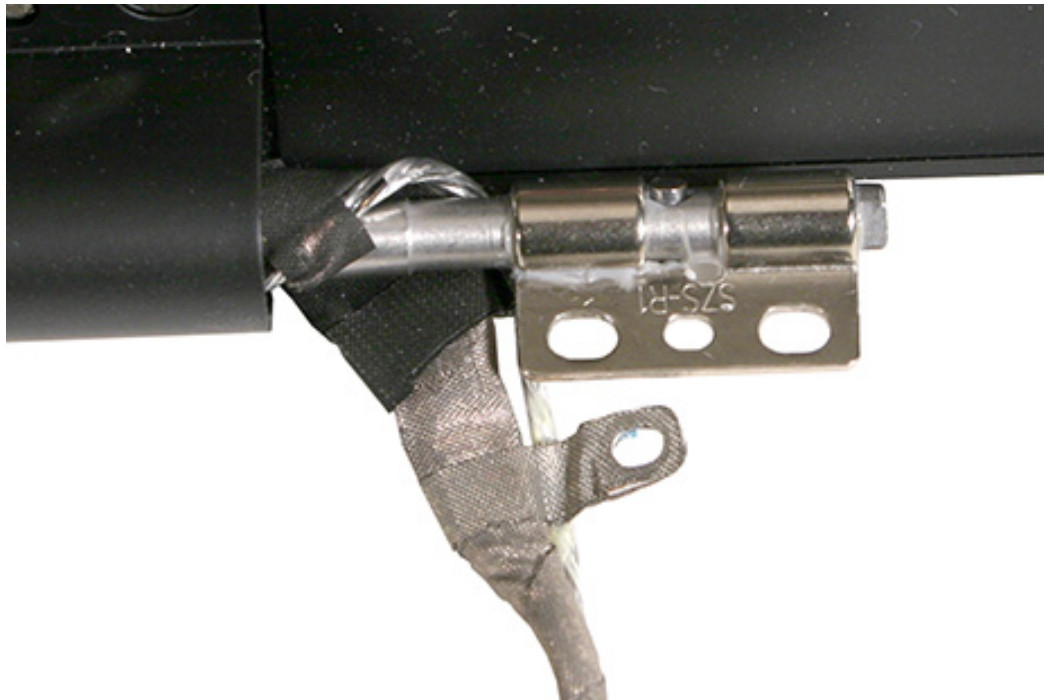

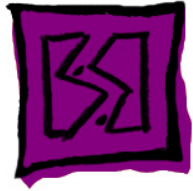

# Screw Charts

## Top Case Screw Locations

**Note:** Screw lengths are approximate and cover the full length of the screw, including the screw head. Screw size, location, and part number details are subject to change. To offer a needed correction, click the Contact Us link on Service Source Online.

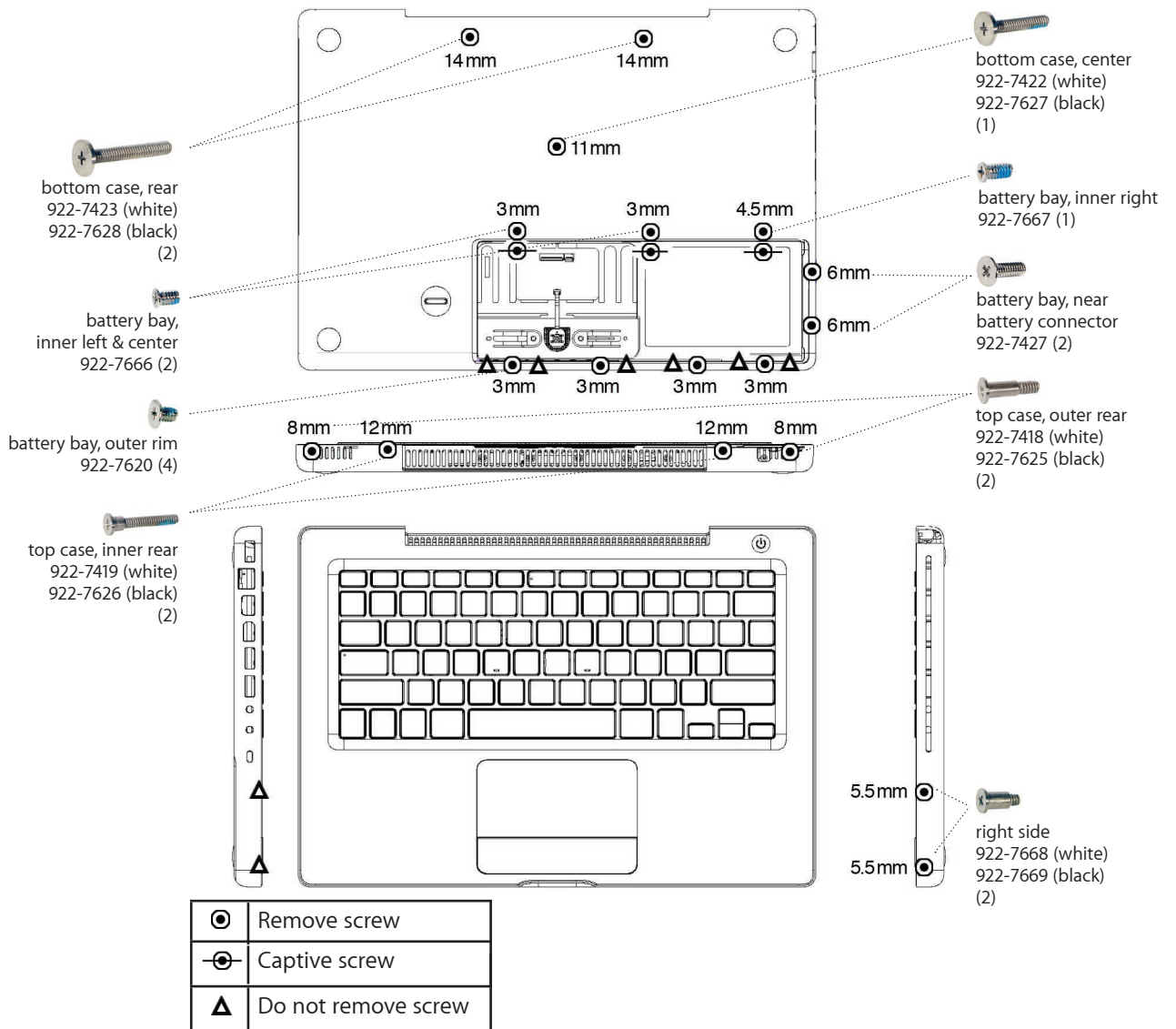

## Display Module Screw Locations

**Note:** Screw lengths are approximate and cover the full length of the screw, including the screw head. Screw size, location, and part number details are subject to change. To offer a needed correction, click the Contact Us link on Service Source Online.

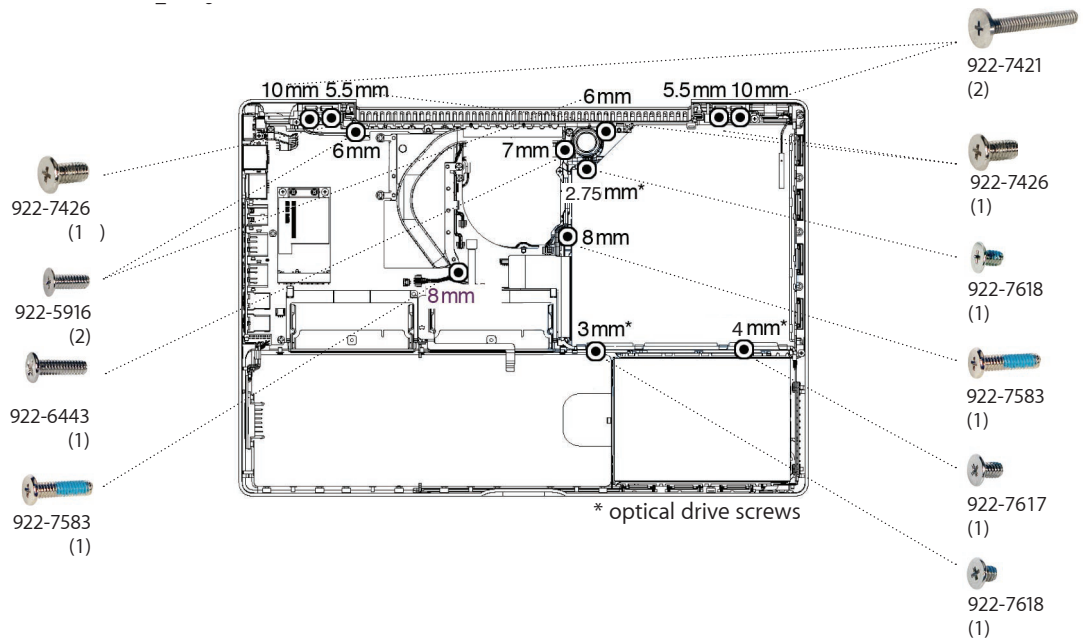

## Optical Drive Bracket Screw Locations

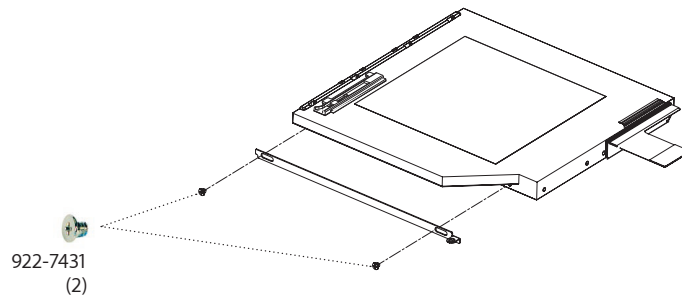

## Logic Board Screw Locations

**Note:** Screw lengths are approximate and cover the full length of the screw, including the screw head. Screw size, location, and part number details are subject to change. To offer a needed correction, click the Contact Us link on Service Source Online.

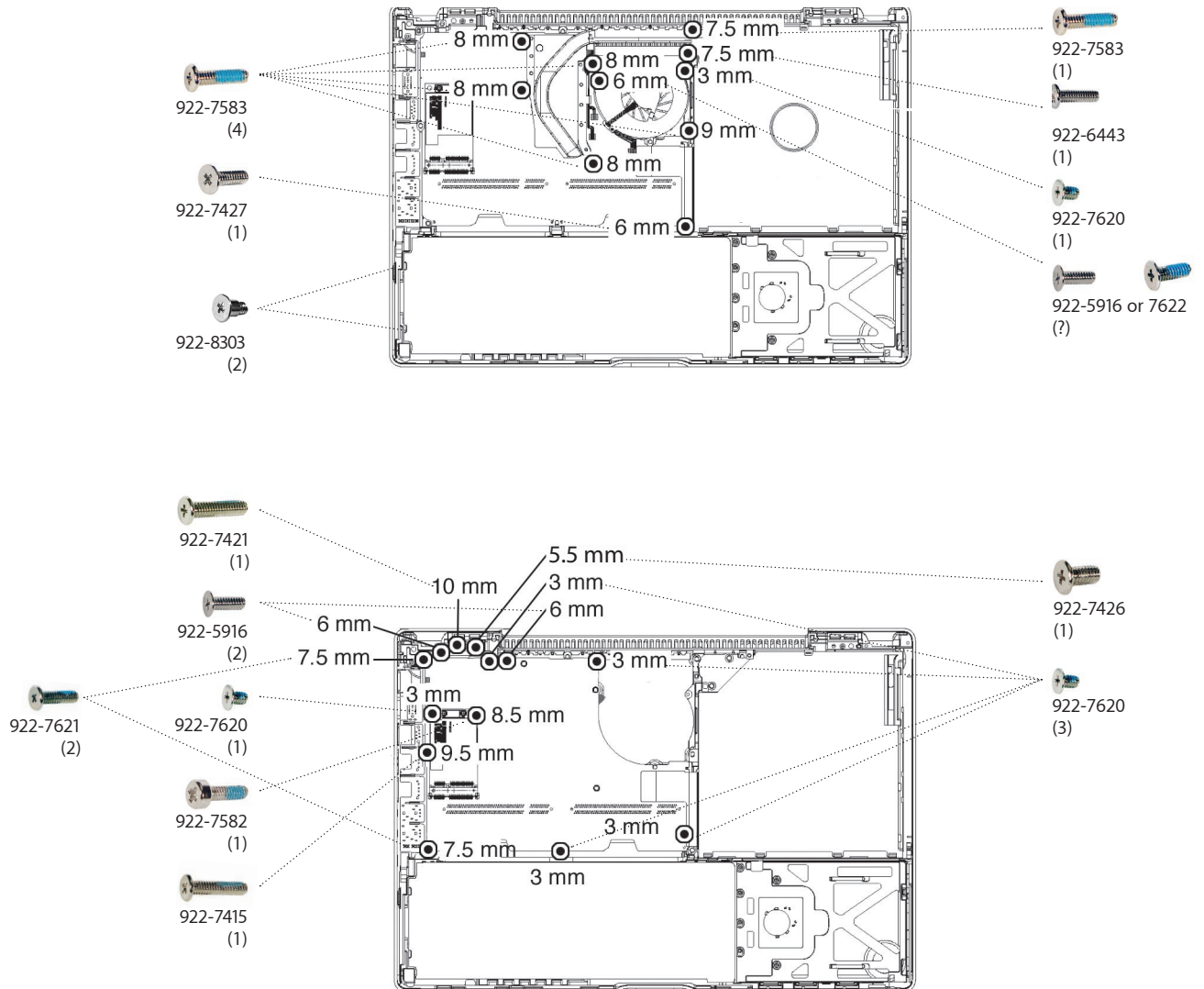

## LCD Panel Screw Locations

**Note:** Screw lengths are approximate and cover the full length of the screw, including the screw head. Screw size, location, and part number details are subject to change. To offer a needed correction, click the Contact Us link on Service Source Online.

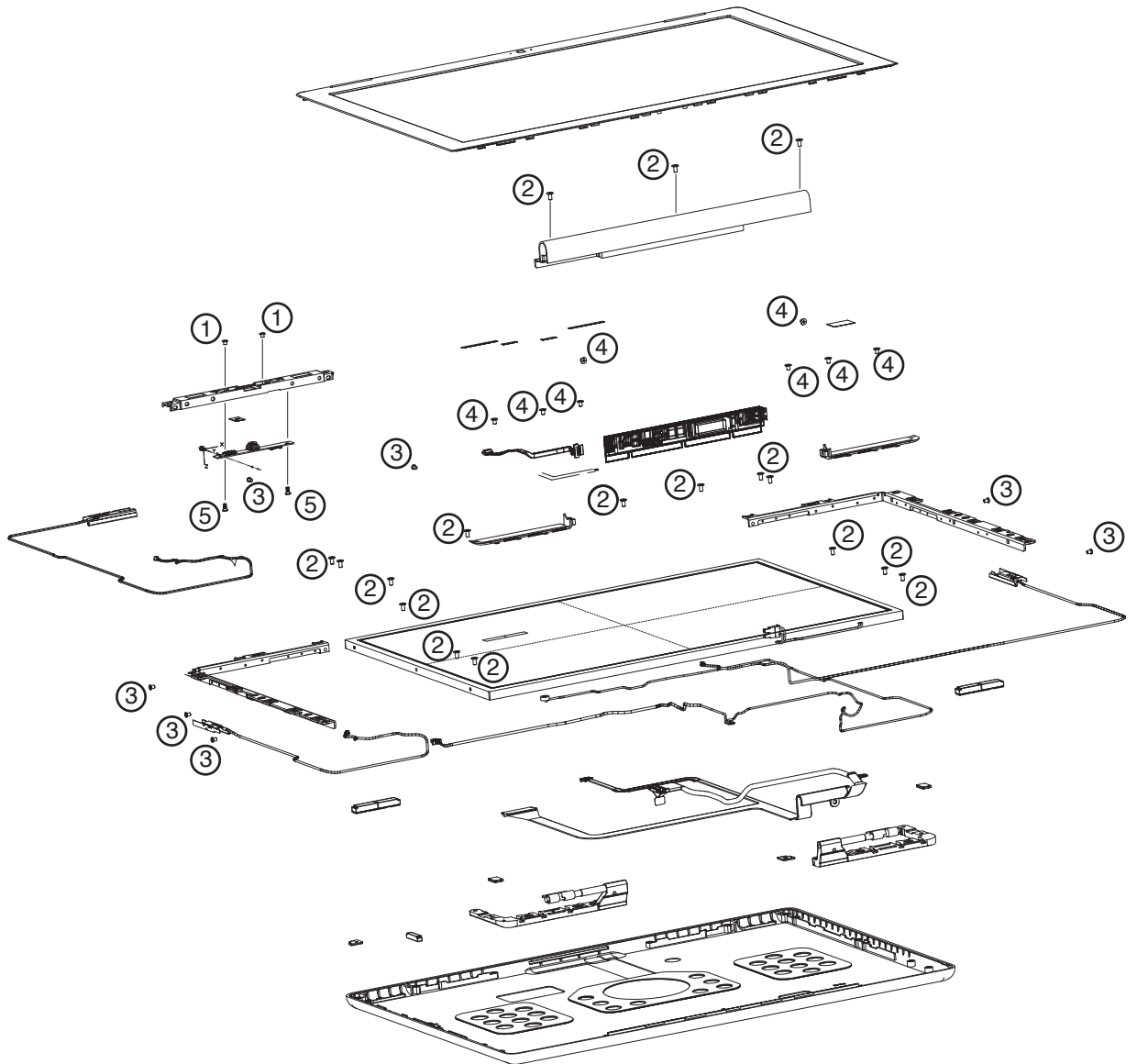







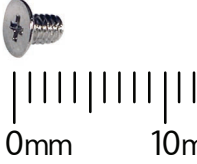
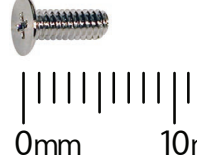
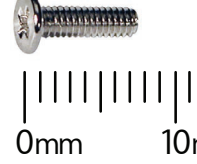
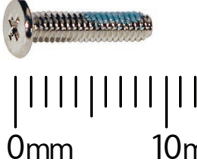
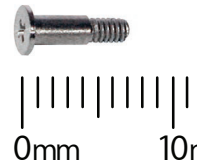
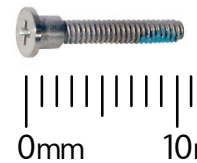
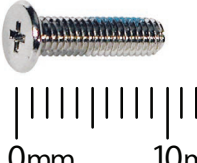
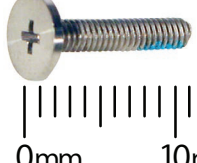
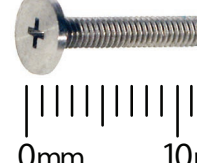
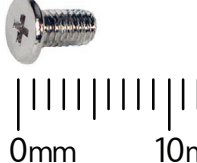
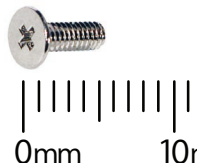
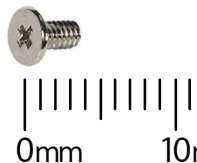







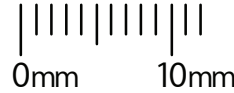

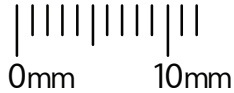



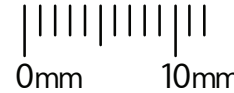

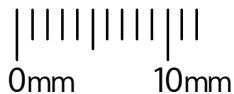
**Legend** Refer to the Screw Reference Chart for screw photos.

- 1 = 922-5910 screws (2) at camera bracket
- 2 = 922-7429 screws, bezel brace to display rear housing; clutch cover
- 3 = 922-7590 screws, bezel brace to LCD panel
- 4 = 922-7620 screws, display hinges to display rear housing
- 5 = 922-8133 shoulder screws (2) at camera board

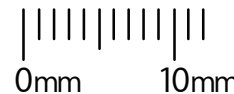
## Screw Reference Chart, Part 1 of 3

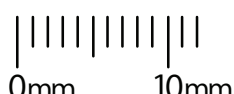

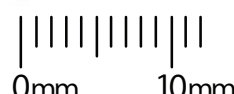

<p><b>922-5911</b>      <b>Phillips #0</b></p>  <p>interchangeable w/ 922-7620? (except no nylock coating)</p>	<p><b>922-5916</b>      <b>Phillips #0</b></p>  <p>fan (upper left corner), MLB, left clutch block</p>	<p><b>922-6443</b>      <b>Phillips #0</b></p>  <p>Bluetooth-to-logic board cable, subwoofer, midframe</p>
<p><b>922-7415</b>      <b>Phillips #0</b></p>  <p>I/O frame</p>	<p><b>922-7418</b>      <b>Phillips #0</b></p>  <p>top case (back, near corner)</p>	<p><b>922-7419</b>      <b>Phillips #0</b></p>  <p>top case (back, near hinge)</p>
<p><b>922-7421</b>      <b>Phillips #0</b></p>  <p>MLB, left &amp; right clutch blocks</p>	<p><b>922-7422</b>      <b>Phillips #0</b></p>  <p>top case (bottom case, rear)</p>	<p><b>922-7423</b>      <b>Phillips #0</b></p>  <p>top case (bottom case, ctr)</p>
<p><b>922-7426</b>      <b>Phillips #0</b></p>  <p>MLB, left &amp; right clutch blocks</p>	<p><b>922-7427</b>      <b>Phillips #0</b></p>  <p>battery bay, midframe</p>	<p><b>922-7429</b>      <b>Phillips #0</b></p>  <p>display assembly</p>

## Screw Reference Chart, Part 2 of 3

<p>922-7430 Torx T8</p>   <p>0mm 10mm</p> <p>hard drive assembly</p>	<p>922-7431 Phillips #0</p>   <p>0mm 10mm</p> <p>optical drive assembly</p>	<p>922-7582 Phillips #0</p>   <p>0mm 10mm</p> <p>Airport card, upper rt corner</p>
<p>922-7583 Phillips #0</p>   <p>0mm 10mm</p> <p>heatsink, midframe</p>	<p>922-7590 Phillips #0</p>   <p>0mm 10mm</p> <p>LCD assembly</p>	<p>922-7617 Phillips #0</p>   <p>0mm 10mm</p> <p>optical drive, upper left corner</p>
<p>922-7618 Phillips #0</p>   <p>0mm 10mm</p> <p>optical drive, right side</p>	<p>922-7620 Phillips #0</p>   <p>0mm 10mm</p> <p>battery bay, BT, speakers, etc.</p>	<p>922-7621 Phillips #0</p>   <p>0mm 10mm</p> <p>I/O frame, top/bottom ends</p>
<p>922-7666 Phillips #0</p>   <p>0mm 10mm</p> <p>battery bay, inner edge, left and center</p>	<p>922-7667 Phillips #0</p>   <p>0mm 10mm</p> <p>battery bay, inner edge right</p>	<p>922-7668 (white) Phillips #0 922-7669 (black)</p>   <p>0mm 10mm</p> <p>top case, right side</p>

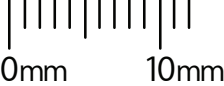
---

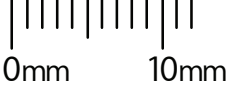
## Screw Reference Chart, Part 3 of 3

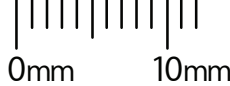
922-5910	Phillips #0	922-8133	Phillips #0	922-8303	Phillips #0
 		 		 	
camera board		camera bracket		battery connector	

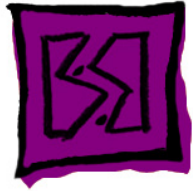

# Exploded Views

## MacBook (13-inch, Early 2009) and MacBook (13-inch, Mid 2009)—Display Exploded View

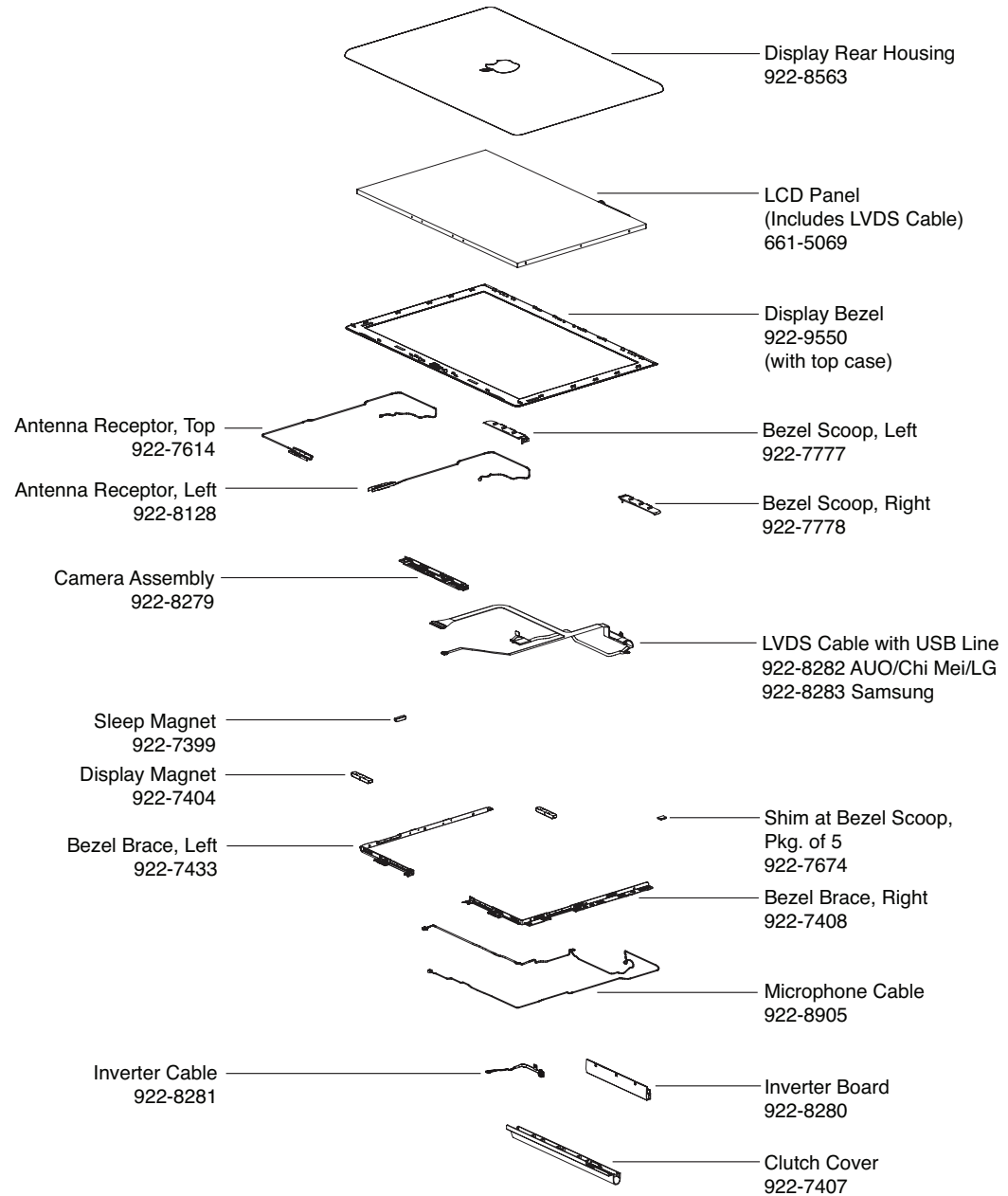

## MacBook (13-inch, Early 2009)—Main Exploded View

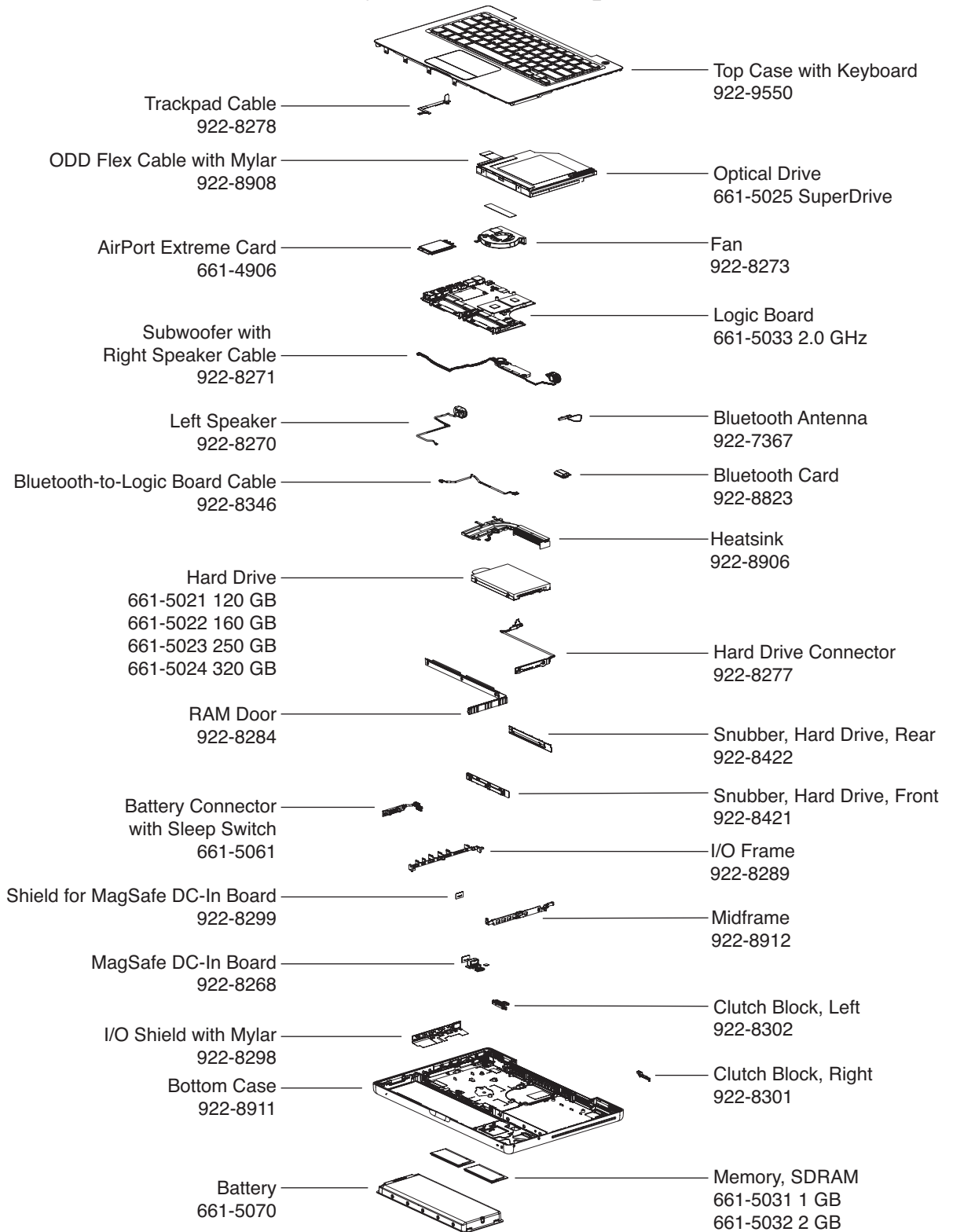

## MacBook (13-inch, Mid 2009)—Main Exploded View

